

1 Selection of standards

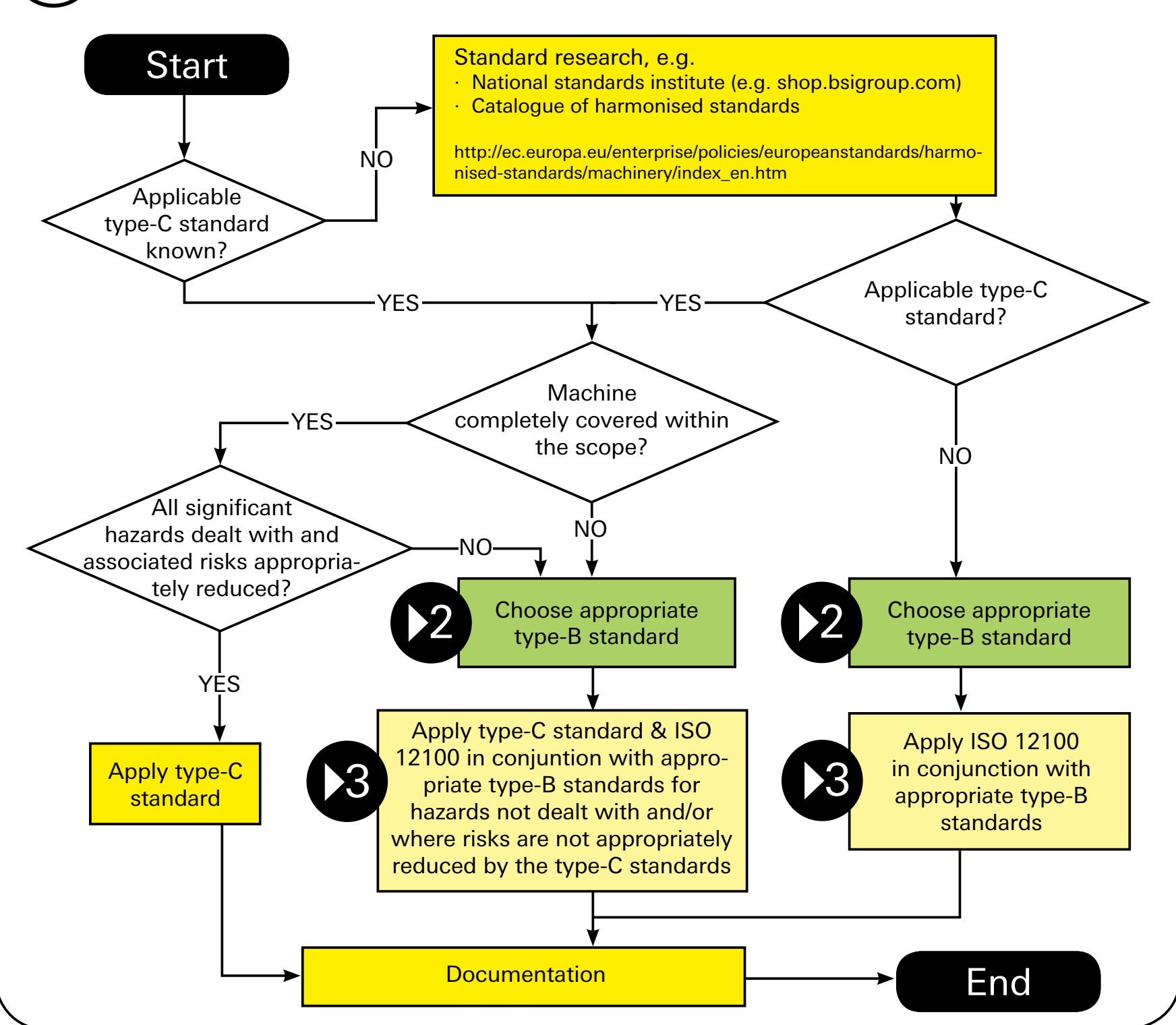

2 Scheme of standards according ISO/TR 22100-1: 2016

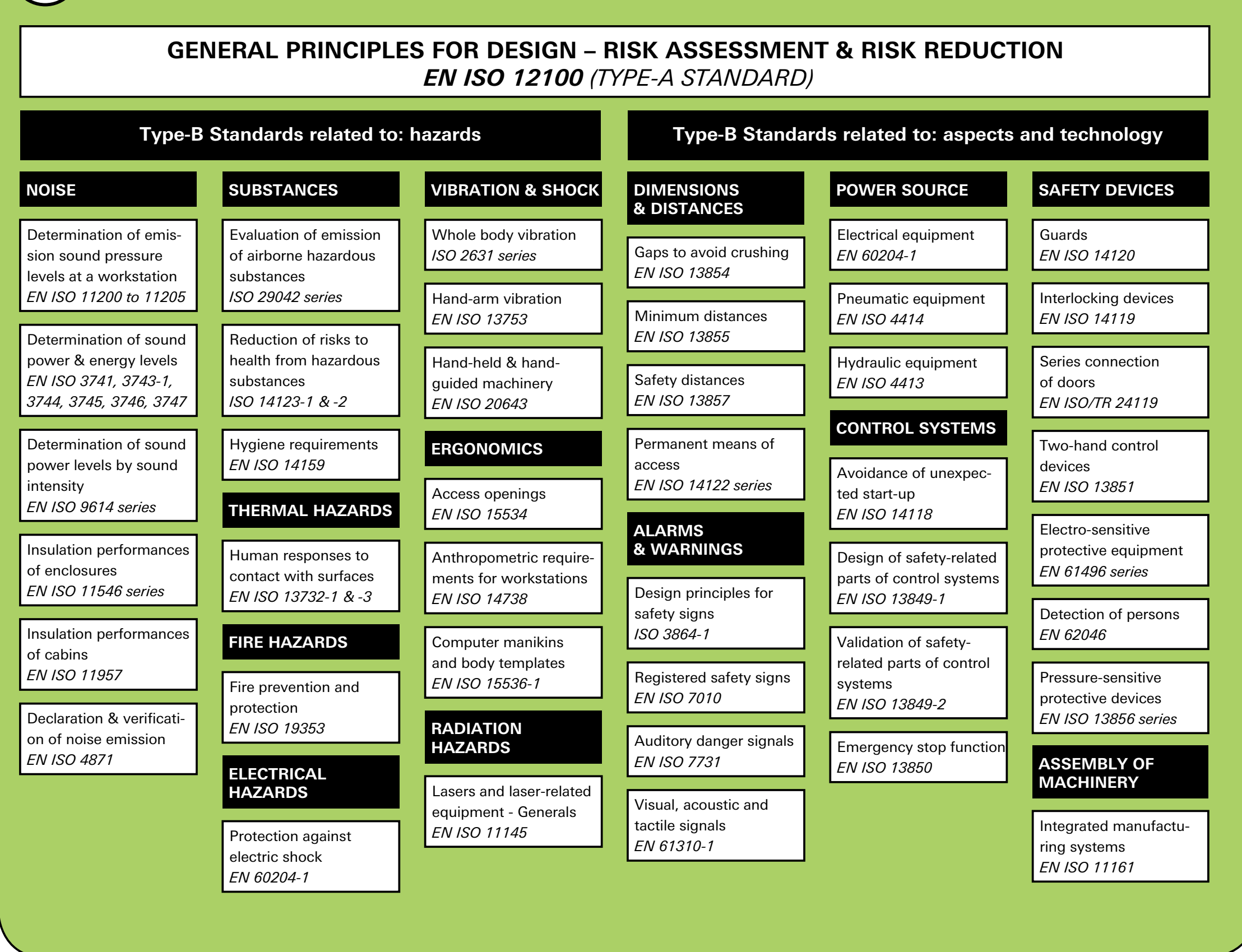

3 Risk evaluation and risk reduction

According to EN ISO 12100:2010, Fig. 1

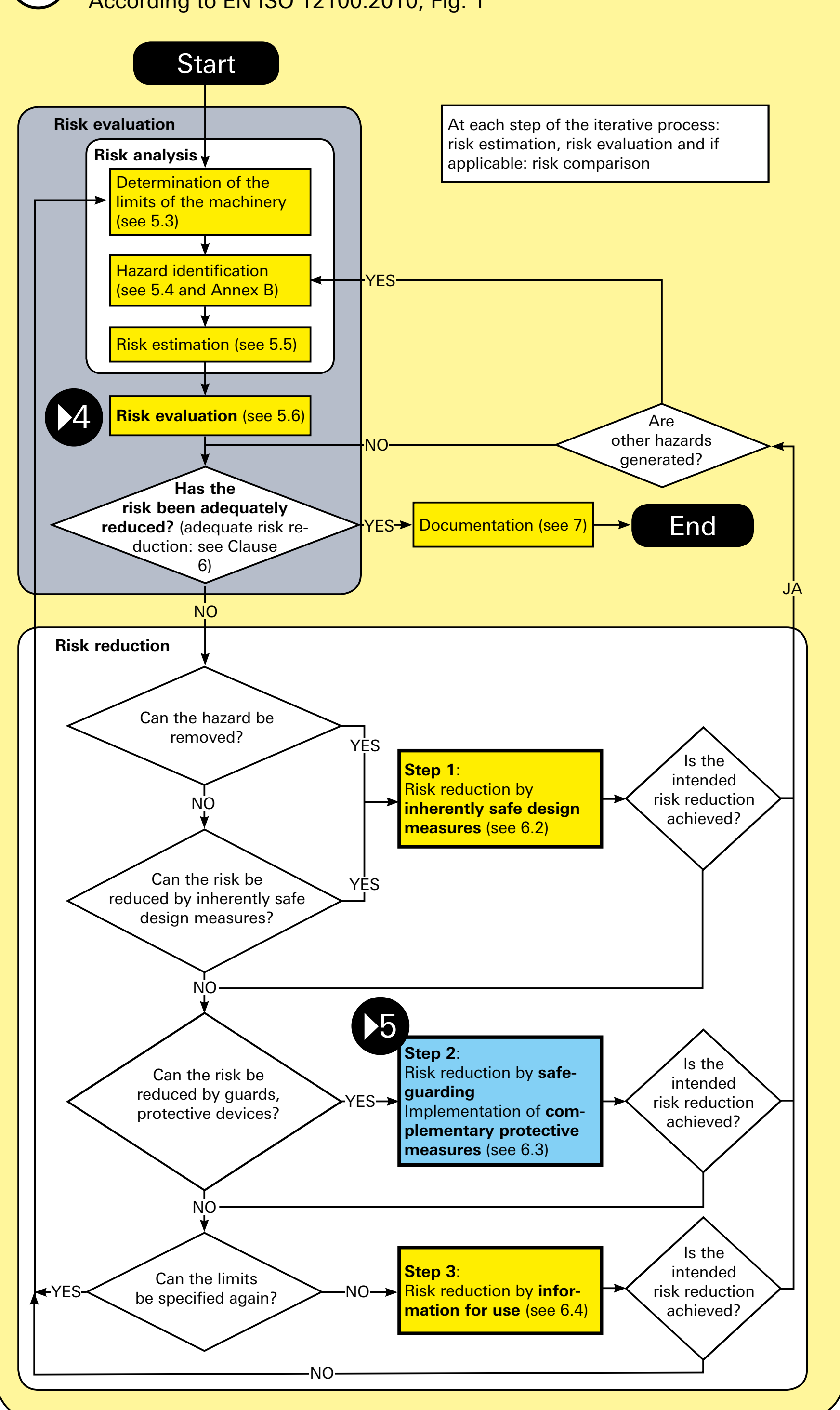

5 Evaluation of technical safeguards

According to EN ISO 13849-1:2016

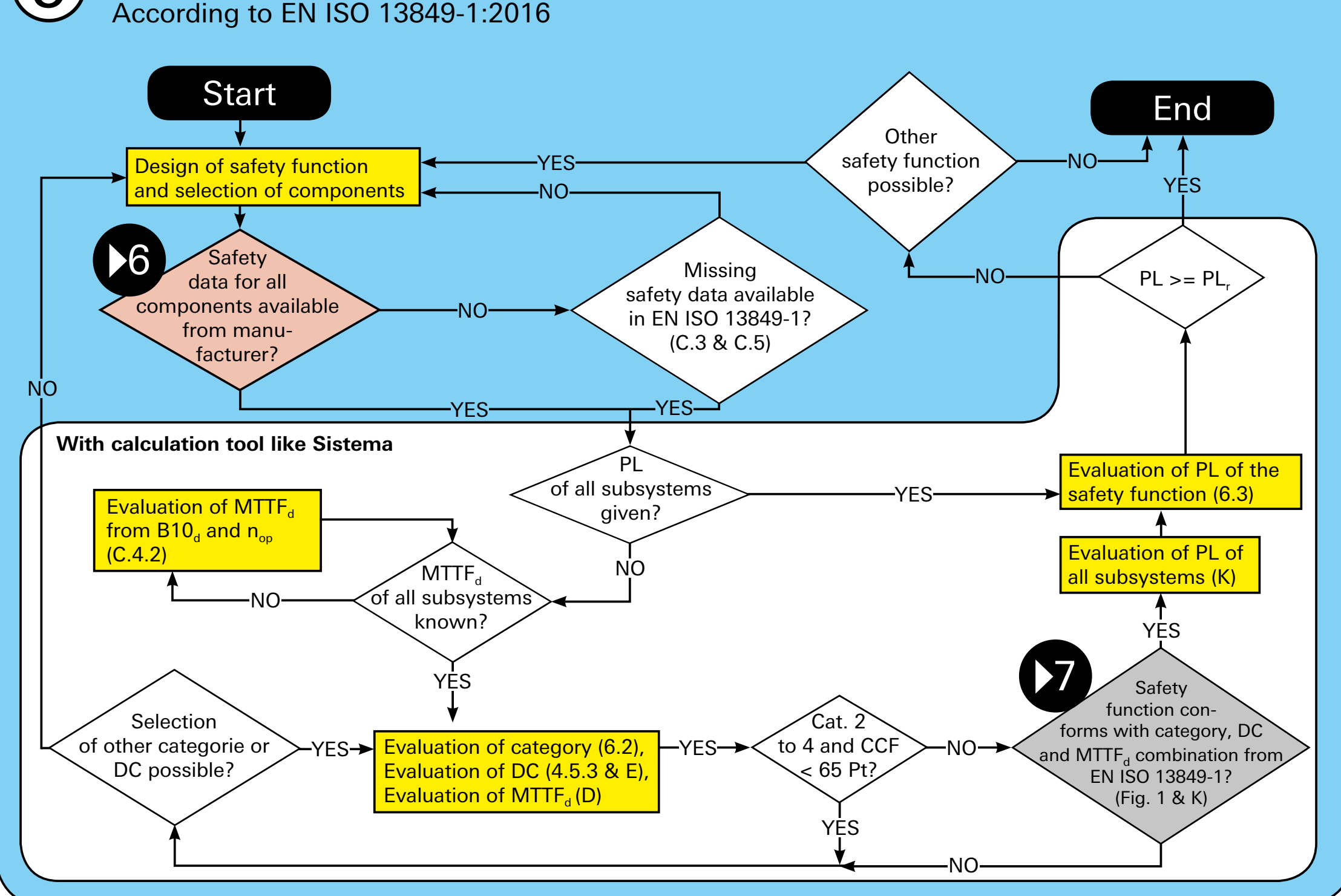

7 Determination PL

According to EN ISO 13849-1:2016, Fig. 5 and Table 4, 5

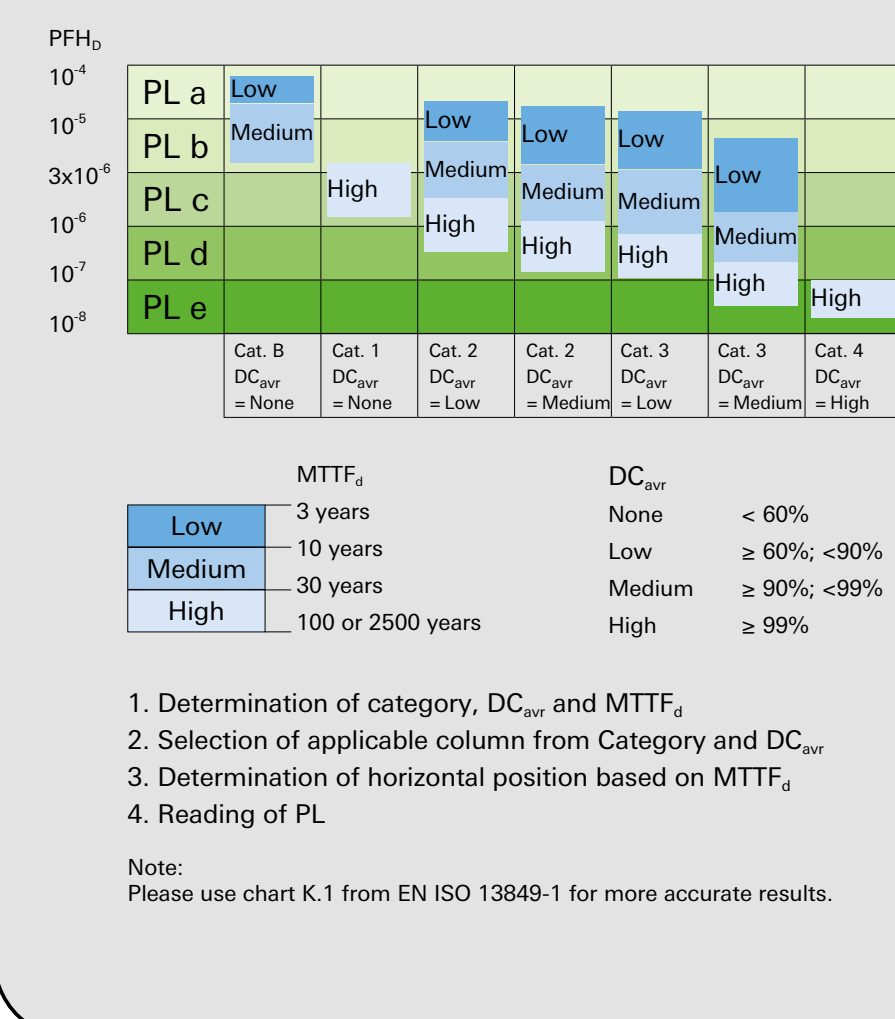

4 Determination PL_r – Risk graph

According to EN ISO 13849-1:2016, Fig. A.1

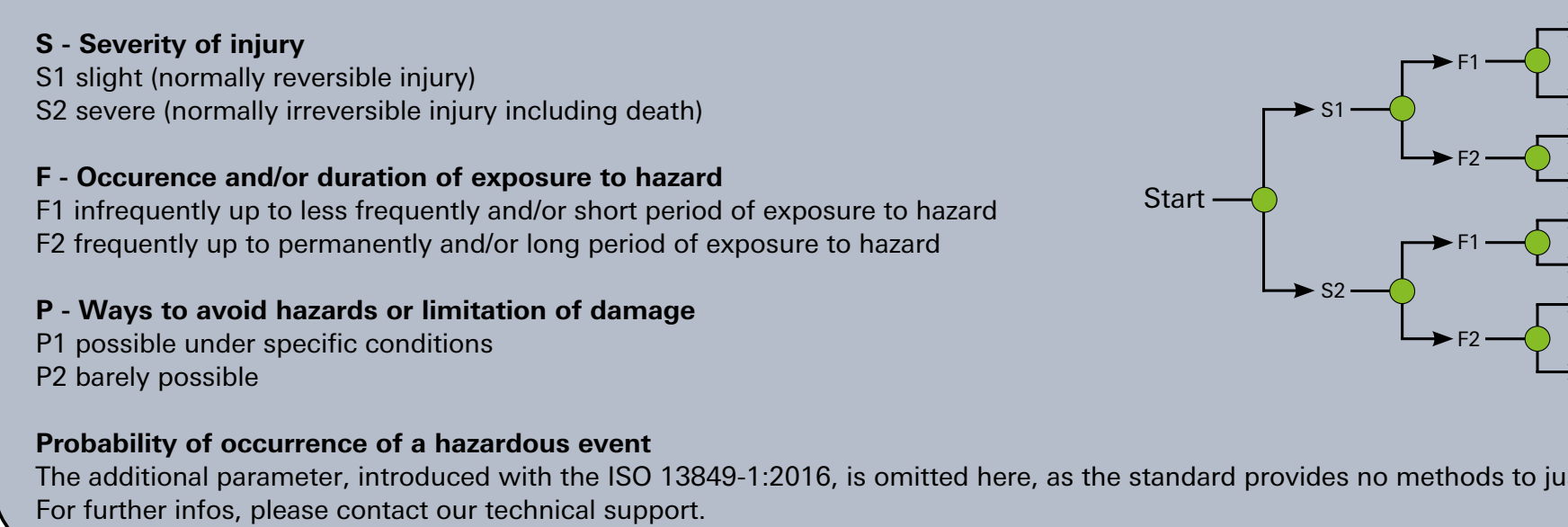

6 Safety specifications

Acc. to VDMA 66413:2012, Fig. 1 (modified)

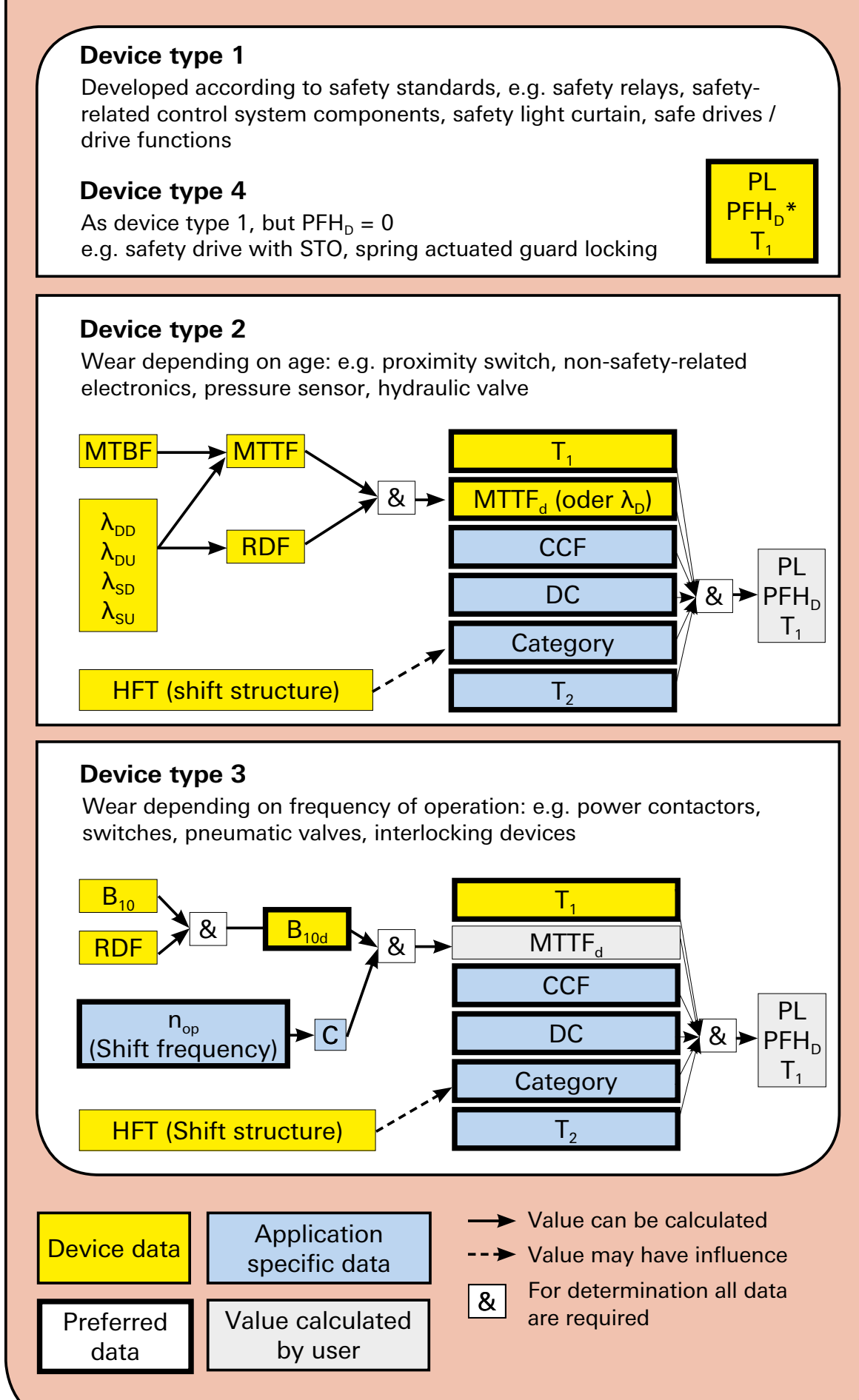

safety service by Wieland