

# MOSAIC

## MODULAR SAFETY INTEGRATED CONTROLLER



(Copy of the original instructions)

### Installation and use



Via Carcano, 32  
10153 Torino, Italy  
[www.reersafety.com](http://www.reersafety.com)  
[info@reer.it](mailto:info@reer.it)

# MODULAR SAFETY INTEGRATED CONTROLLER

## TABLE OF CONTENTS

INTRODUCTION .....	8
Contents of this handbook .....	8
Important safety instructions.....	8
Abbreviations and symbols.....	9
Applicable standards.....	10
OVERVIEW.....	11
Master MOSAIC M1 / MOSAIC M1S / MOSAIC M1S COM.....	11
MOSAIC M1S COM key features .....	12
MOSAIC M1S COM and MBx in the same project: Fieldbus management .....	13
Expansion modules .....	13
MSD software.....	14
PRODUCT COMPOSITION.....	15
INSTALLATION .....	16
MOSAIC M1, MOSAIC M1S, Expansion Modules mechanical fastening .....	16
MOSAIC M1S COM Mechanical fastening .....	17
Calculation of safety distance of an ESPE connected to MOSAIC .....	18
Electrical connections .....	18
Instructions concerning connection cables.....	19
Master Module MOSAIC M1.....	19
Master Modules MOSAIC M1S / MOSAIC M1S COM .....	20
USB interface.....	21
LAN interface (RJ45) .....	21
MOSAIC Configuration Memory (MCM).....	21
Module MI8O2 .....	23
Module MI8O4 .....	24
Module MI8 .....	25
Module MI12T8 .....	25
Module MI16 .....	26
Module MO2 .....	26
Module MO4 .....	27
Module MO4L.....	27
Module MR2.....	28
Module MR4 .....	28
Module MR8.....	29
Modules MV0 - MV1 - MV2 .....	30
Encoder connections with RJ45 connector (MV1, MV2).....	30
Module MOR4 .....	32
Module MOR4S8.....	32
Module MOS8.....	33
Module MOS16.....	33
Module MO4LHCS8.....	34
Modulo MA2 .....	34
Modulo MA4 .....	35
MA2 / MA4 Analog sensor connections .....	36
Example of connection of Mosaic to the machine control system.....	37

Checklist after installation .....	37
OPERATING DIAGRAM.....	38
SIGNALS.....	39
INPUTS .....	39
MASTER ENABLE .....	39
NODE SEL .....	39
PROXIMITY INPUT FOR SPEED CONTROLLER MV .....	39
Configuration With Interleaved Proximity.....	40
RESTART_FBK .....	40
OUTPUTS.....	41
OUT STATUS (SIL 1/PL c).....	41
OUT TEST .....	41
OSSD SAFETY OUTPUTS .....	42
Important note concerning OSSD Safety Outputs .....	42
OSSD (MOSAIC M1, MI8O2, MO2, MO4).....	42
OSSD (MOSAIC M1S, MOSAIC M1S COM, MI8O4, MO4L).....	42
OSSD (MO4LHCS8).....	44
OSSD OUTPUTS CONFIGURATION.....	45
SAFETY RELAYS (MR2, MR4, MR8, MOR4, MOR4S8).....	46
Characteristics of the output circuit.....	46
MR2/MR4/MR8 internal contacts diagram.....	46
Example of MR2 module connection with static OSSD of a module MOSAIC M1 ...	47
Switching operation timing diagram. ....	48
TECHNICAL FEATURES .....	49
GENERAL SYSTEM CHARACTERISTICS .....	49
Safety level parameters .....	49
General data.....	49
Enclosure .....	50
MOSAIC M1 module .....	51
MOSAIC M1S module.....	51
MOSAIC M1S COM module .....	52
MI8O2 module .....	52
MI8O4 module .....	53
MI8 - MI16 modules.....	53
MI12T8 module.....	53
MO2 - MO4 modules.....	54
MO4L module.....	54
MOS8 - MOS16 modules .....	54
MR2 - MR4 - MR8 modules .....	55
MOR4 - MOR4S8 module.....	55
MO4LHCS8 module .....	56
MV0 - MV1 - MV2 modules.....	56
MA2, MA4 module.....	58
MECHANICAL DIMENSIONS.....	59
LED INDICATORS (Normal Operation) .....	60
Master MOSAIC M1 (Figure 20) .....	60
Master MOSAIC M1S (Figure 20).....	61
Master MOSAIC M1S COM (Figure 20) .....	62
MOSAIC M1S COM specific Fieldbus LED indicators .....	63
EtherCAT LEDs .....	63
LED state explanation.....	63
EtherNET/IP LEDs .....	64
LED state explanation.....	65

Modbus/TCP LEDs.....	65
LED state explanation.....	65
PROFINET LEDs.....	66
LED state explanation.....	66
MI8O2 (Figure 23) .....	67
MI8O4 (Figure 23) .....	68
MI8 (Figure 25).....	69
MI12T8 (Figure 27).....	70
MI16 (Figure 27).....	71
MO2 (Figure 28) .....	72
MO4 (Figure 29) .....	73
MO4L (Figure 23) .....	74
MOR4 (Figure 31) .....	75
MOR4S8 (Figure 32) .....	76
MOS8 (Figure 33) .....	77
MOS16 (Figure 34) .....	78
MV0, MV1, MV2 (Figure 35) .....	79
MR2, MR4, MR8 (Figure 36) .....	80
MO4LHCS8 (Figure 37) .....	81
MA2, MA4 (Figure 38).....	82
LED INDICATORS (Troubleshooting) .....	83
Master MOSAIC M1 (Figure 39) .....	83
Master MOSAIC M1S / MOSAIC M1S COM (Figure 40) .....	84
MI8O2 (Figure 41) .....	85
MI8O4 (Figure 42) .....	86
MI8 (Figure 43).....	87
MI12T8 (Figure 44).....	88
MI16 (Figure 45).....	89
MO2 / MO4 (Figure 46) .....	90
MO4L (Figure 47) .....	91
MOR4 (Figure 48).....	92
MOR4S8 (Figure 49) .....	93
MOS8 (Figure 50) .....	94
MOS16 (Figure 51) .....	95
MV0, MV1, MV2 (Figure 52) .....	96
MO4LHCS8 (Figure 53) .....	97
MA2, MA4 (Figure 54).....	98
MOSAIC SAFETY DESIGNER SOFTWARE .....	100
Installing the software .....	100
PC HARDWARE requirements .....	100
PC SOFTWARE requirements .....	100
Installation of MSD software .....	100
Fundamentals .....	101
Standard toolbar .....	102
Textual toolbar .....	103
Create a new project (configure the MOSAIC system) .....	103
Create a new project: MOSAIC M1S COM fieldbus parameters configuration .....	105
ModBus TCP parameters.....	105
EtherNet/IP parameters .....	105
Profinet RT parameters.....	106
EtherCat parameters.....	107
Edit Configuration (composition of the various modules) .....	107

Change user parameters .....	107
Objects - Operator - Configuration toolbars.....	108
Creating the diagram .....	109
Use of mouse right button .....	110
Example of a project .....	111
Project validation .....	111
Resources Allocation .....	112
Project report.....	113
Connect MSD to Mosaic Master.....	115
Communication channel selection .....	115
USB connection .....	115
Network Connection (MOSAIC M1S COM only) .....	115
Connected Master parameters visualization .....	119
MOSAIC M1S COM connected via LAN.....	119
MOSAIC M1S COM connected via USB.....	119
MOSAIC M1/MOSAIC M1S connected via USB.....	120
Operations available with master connected (MOSAIC M1S COM).....	121
Visualization network parameters .....	121
Visualization/setting network parameters (MOSAIC M1S COM) .....	121
Download project to MOSAIC (from PC) .....	122
Upload an existing project to PC (from MOSAIC).....	123
Configurations LOG.....	123
System composition .....	123
Errors Log .....	124
Disconnecting System .....	124
Monitor functions.....	124
Monitor (I/O status in real time - textual).....	124
Monitor (I/O status in real time - textual - graphic) .....	125
Password protection.....	126
Level 1 password.....	126
Level 2 password.....	126
Password Change.....	127
Testing the system.....	127
OBJECT FUNCTION BLOCKS.....	129
OUTPUT OBJECTS .....	129
OSSD (safety outputs).....	129
SINGLE-DOUBLE OSSD (safety output).....	130
STATUS (SIL 1/PL c output) .....	133
FIELDBUS PROBE .....	133
RELAY .....	134
Use with RESTART: Automatic (A) or Manual (B) (Category 2) .....	135
INPUT OBJECTS.....	137
E-STOP (emergency stop) .....	137
E-GATE (safety gate device).....	138
SINGLE E-GATE (safety gate device) .....	139
LOCK FEEDBACK.....	140
ENABLE (enable key) .....	141
ESPE (optoelectronic safety light curtain / laser scanner) .....	142
FOOTSWITCH (safety pedal).....	143
MOD-SEL (safety selector) .....	145
PHOTOCELL (safety photocell) .....	145
TWO-HAND (bimanual control).....	146
NETWORK_IN.....	147
SENSOR .....	147
S-MAT (safety mat) .....	148
SWITCH .....	149

ENABLING GRIP SWITCH .....	150
TESTABLE SAFETY DEVICE .....	151
SOLID STATE DEVICE .....	153
RESTART INPUT .....	154
FIELDBUS INPUT .....	154
LLO-LL1 .....	154
COMMENTS .....	155
TITLE .....	155
SPEED CONTROL TYPE FUNCTION BLOCKS.....	156
Warning concerning safety .....	156
Note concerning Speed Control Functional Blocks .....	156
SPEED CONTROL.....	157
WINDOW SPEED CONTROL .....	160
STAND STILL .....	162
STAND STILL AND SPEED CONTROL .....	164
ANALOG INPUT TYPE FUNCTION BLOCKS.....	167
ANALOG INPUT (4 inputs each MA4 module, 2 inputs each MA2 module) .....	167
ANALOG DIVISION (4 inputs each MA4 module, 2 inputs each MA2 module).....	178
OPERATOR FUNCTION BLOCKS.....	192
LOGICAL OPERATORS .....	192
AND .....	192
NAND.....	192
NOT .....	193
OR .....	193
NOR .....	193
XOR .....	194
XNOR.....	194
LOGICAL MACRO .....	194
MULTIPLEXER.....	195
DIGITAL COMPARATOR (MOSAIC M1S, MOSAIC M1S COM only).....	195
MEMORY OPERATORS .....	198
D FLIP FLOP (max number = 16).....	198
T FLIP FLOP (max number = 16) .....	198
SR FLIP FLOP.....	198
USER RESTART MANUAL (max number = 16 with MOSAIC M1, 32 with MOSAIC M1S, MOSAIC M1S COM with other RESTART operators).....	199
USER RESTART MONITORED (max number = 16 with MOSAIC M1, 32 with MOSAIC M1S, MOSAIC M1S COM with other RESTART operators) .....	200
MACRO RESTART MANUAL (max number = 16 with MOSAIC M1, 32 with MOSAIC M1S, MOSAIC M1S COM with other RESTART operators) .....	200
MACRO RESTART MONITORED (max number = 16 with MOSAIC M1, 32 with MOSAIC M1S, MOSAIC M1S COM with other RESTART operators) .....	201
PRE-RESET (MOSAIC M1S, MOSAIC M1S COM only) (max number = 32 with other RESTART operators).....	202
GUARD LOCK OPERATOR (max number = 4 with MOSAIC M1, 8 with MOSAIC M1S, MOSAIC M1S COM).....	203
GUARD LOCK .....	203
COUNTER OPERATORS .....	215
COUNTER (max number = 16).....	215
COUNTER COMPARATOR.....	216
TIMER OPERATORS (max number = 32 with MOSAIC M1, 48 with MOSAIC M1S, MOSAIC M1S COM) .....	217
MONOSTABLE.....	217
MONOSTABLE_B .....	218
PASSING MAKE CONTACT .....	219
DELAY .....	220

LONG DELAY .....	221
DELAY COMPARATOR .....	222
DELAY LINE .....	222
<b>LONG DELAY LINE</b> .....	223
CLOCKING .....	224
MUTING FUNCTION .....	225
MUTING OPERATORS (max number = 4 with MOSAIC M1, 8 with MOSAIC M1S/MOSAIC M1S COM) .....	225
"Concurrent" MUTING .....	225
<b>MUTING "L"</b> .....	226
"Sequential" MUTING .....	227
<b>MUTING "T"</b> .....	228
MUTING OVERRIDE (max number = 4) .....	229
ANALOG OPERATORS (MOSAIC M1S/MOSAIC M1S COM) .....	231
ANALOG COMPARATOR .....	231
Math (max number = 16) .....	233
EQUALITY CHECK (max number = 16) .....	234
MISCELLANEOUS FUNCTION BLOCKS .....	234
SERIAL OUTPUT (max number = 4 with MOSAIC M1, 8 with MOSAIC M1S, MOSAIC M1S COM) .....	234
NETWORK (max number = 1) .....	235
Example of application in Category 2 according to ISO 13849-1: .....	239
Logical block diagram of a safety function using the network .....	240
Example of application in Category 4 according to ISO 13849-1: .....	240
Logical block diagram of a safety function using the network .....	241
RESET MOSAIC M1 .....	241
OSSD EDM (MOSAIC M1S / MOSAIC M1S COM, max number = 32) .....	241
INTERPAGE IN/OUT .....	242
INTFBK_IN / INTFBK_OUT (MOSAIC M1S/MOSAIC M1S COM only, max number = 8) .....	243
.....	243
TERMINATOR .....	243
Special Applications .....	244
Output delay with manual .....	244
Simulator .....	245
Schematic Simulation .....	246
How to use graphic simulation .....	247
Application example of graphic simulation .....	251
Mosaic Fail Codes .....	253
Errors Log .....	254
ACCESSORIES AND SPARE PARTS .....	255
WARRANTY .....	256
EC DECLARATION OF CONFORMITY .....	257

## INTRODUCTION

### Contents of this handbook











This handbook describes how to use the MOSAIC programmable safety module and its expansion units ("SLAVES"); it includes:

- a description of the system
- method of installation
- connections
- signals
- troubleshooting
- use of the configuration SW

### Important safety instructions

 This safety alert symbol indicates a potential **personal safety hazard**. Failure to comply with instructions bearing this symbol could pose a very serious risk to personnel.

 This symbol indicates an important instruction.

-  The MOSAIC is built to the following safety levels: SIL 3, SILCL 3, PL e, Cat. 4, Type 4 in accordance with the applicable standards. However, the definitive SIL and PL of the application will depend on the number of safety components, their parameters and the connections that are made, as per the risk analysis.
-  Read the "Applicable Standards" section carefully.
-  Perform an in-depth risk analysis to determine the appropriate safety level for your specific application, on the basis of all the applicable standards.
-  Programming/configuration of the Mosaic is the sole responsibility of the installer or user.
-  The device must be programmed/configured in accordance with the application-specific risk analysis and all the applicable standards.
-  Once you have programmed/configured and installed the Mosaic and all the relative devices, run a complete application safety test (see the "TESTING the system" section, page 127).
-  Always test the complete system whenever new safety components are added (see the "TESTING the system" page 127).
-  ReeR is not responsible for these operations or any risks in connection therewith.
-  Reference should be made to the handbooks and the relative product and/or application standards to ensure correct use of devices connected to the Mosaic within the specific application.
-  The ambient temperature in the place where the system is installed must be compatible with the operating temperature parameters stated on the product label and in the specifications.
-  For all matters concerning safety, if necessary, contact your country's competent safety authorities or the competent trade association.



---

## Abbreviations and symbols

---

AES =	Advanced Encryption Standard
CIP =	Common Industrial Protocol
DHCP =	Dynamic Host Control Protocol
DNS =	Domain Name Server
FW =	Firmware
LAN =	Local Area Network
MCM =	MOSAIC Configuration Memory: <i>memory chip for MOSAIC M1, MOSAIC M1S, MOSAIC M1S COM (accessory)</i>
MSC =	MOSAIC Safety Communication: <i>proprietary bus for expansion units</i>
MSD =	MOSAIC Safety Designer: <i>MOSAIC configuration SW running in Windows</i>
LLO, LL1 =	Logic Level 0, Logic Level 1
OMB =	Open Modbus/TCP
OSSD =	Output Signal Switching Device: <i>solid state safety output</i>
MTTF <sub>d</sub> =	Mean Time to Dangerous Failure
PL =	Performance Level
PFH <sub>d</sub> =	Probability of a dangerous failure per Hour
SIL =	Safety Integrity Level
SILCL =	Safety Integrity Level Claim Limit
SW =	Software
TCP/IP =	Transmission Control Protocol / Internet Protocol

## Applicable standards

MOSAIC complies with the following European Directives:

- 2006/42/EC "Machinery Directive"
- 2014/30/EU "Electromagnetic Compatibility Directive"
- 2014/35/EU "Low Voltage Directive"

and is built to the following standards:

CEI EN 61131-2	Programmable controllers, part 2: Equipment requirements and tests
EN ISO 13489-1	Safety of machinery: Safety related parts of control systems. General principles for design
EN 61496-1	Safety of machinery: Electro-sensitive protective equipment. Part 1: General requirements and tests.
EN 61508-1	Functional safety of electrical/electronic/programmable electronic safety-related systems: General requirements.
EN 61508-2	Functional safety of electrical/electronic/programmable electronic safety-related systems: Requirements for electrical/electronic/programmable electronic safety-related systems.
EN 61508-3	Functional safety of electrical/electronic/programmable electronic safety-related systems: Software requirements.
EN 61508-4	Functional safety of electrical/electronic programmable electronic safety related systems: Definitions and abbreviations.
IEC 61784-3	Digital data communication for measurement and control: Functional safety fieldbuses.
EN 62061	Safety of machinery. Functional safety of safety-related electrical, electronic and programmable electronic control systems
EN 81-20	Safety rules for the construction and installation of lifts. Lifts for the transport of persons and goods. Passenger and goods passenger lifts
EN 81-50	Safety rules for the construction and installation of lifts. Examinations and tests. Design rules, calculations, examinations and tests of lift components

*Table 1*

## OVERVIEW

MOSAIC is a modular safety controller. It consists of a master unit (MOSAIC M1, MOSAIC M1S or MOSAIC M1S COM), which can be configured using the MSD graphic interface, and a number of expansion units connected to the main unit via the proprietary MSC bus.

The MOSAIC M1, MOSAIC M1S, MOSAIC M1S COM can also be used as a stand-alone device and they are equipped with:

- MOSAIC M1: 8 safety inputs, 2 independent programmable dual channel safety outputs (OSSD) and 2 SIL 1/PL c outputs
- MOSAIC M1S: 8 safety inputs, 4 independent programmable single channel safety outputs (OSSD) and up to 4 SIL 1/PL c outputs
- MOSAIC M1S COM: 8 safety inputs, 4 independent programmable single channel safety outputs (OSSD), up to 4 SIL 1 / PL c outputs and enhanced communications features (see "MOSAIC M1S COM key features").

➔ The following expansions are available: I/O expansions (**MI802 and MI804 (with MOSAIC M1S, MOSAIC M1S COM only)**), input expansions (**MI8, MI12T8, MI16**), output expansions (**MO2, MO4 and MO4LHCS8 and MO4L (only for MOSAIC M1S, MOSAIC M1S COM)**), SIL 1/PL c output expansions (**MOS8 and MOS16**), guided contact safety relay output modules (**MR2, MR4, MR8, MOR4 and MOR4S8**), encoder and proximity input expansions (**MV2, MV, MV0**), modules with analog inputs (**MA2, MA4 only for MOSAIC M1S, MOSAIC M1S COM**) and diagnostic connections to the main fieldbuses: **MBP** (PROFIBUS), **MBC** (CanOpen), **MBD** (DeviceNet), **MBEI** (ETHERNET/IP), **MBEP** (Profinet), **MBEC** (ETHERCAT), **MBMR** (Modbus RTU), **MBEM** (Modbus/TCP) **MBCCL** (CC-link).

MOSAIC is capable of monitoring the following safety sensors and commands:

optoelectronic sensors (safety light curtains, scanners, safety photocells), mechanical switches, safety mats, emergency stops, two-hand controls, all managed by a single flexible and expandable device.

### Master MOSAIC M1 / MOSAIC M1S / MOSAIC M1S COM

The system must consist of just one Master MOSAIC M1, MOSAIC M1S, MOSAIC M1S COM and a number of electronic expansions that can range from 0 to a maximum of 14, not more than 4 of which of the same type. There is no limit to the number of relay modules MR2 e MR4 that can be installed.

With 14 expansions, the system can have up to:

- with MOSAIC M1: 128 inputs, 16 safety outputs and 32 SIL 1/ PL c outputs.
- with MOSAIC M1S, MOSAIC M1S COM: 128 inputs, 32 safety outputs and 48 SIL 1/ PL c outputs.

MASTER and its SLAVE units communicate via the 5-way MSC bus (Reer proprietary bus), physically arranged on the rear panel of each unit.

Furthermore, by means of MBx Fieldbus interfaces or MOSAIC M1S COM or both, are available:

- All inputs states (with diagnostics)
- All safety outputs states (with diagnostics)

- 8 fieldbus inputs with MOSAIC M1 or 32 fieldbus inputs with MOSAIC M1S, MOSAIC M1S COM (MBx **firmware version**  $\geq$  2.0). These fieldbus inputs can act in the schematic as physical inputs, but are not safety inputs and they can't be used in safety related applications.
- 16 probe outputs with MOSAIC M1 or 32 probe outputs with MOSAIC M1S, MOSAIC M1S COM (**MBx firmware version**  $\geq$  2.0). These probe outputs can be connected everywhere in the schematic by means of MSD software.

### MOSAIC M1S COM key features

The new MOSAIC M1S COM is equipped with LAN connectivity. It performs the same functions as MOSAIC M1S and thus even USB connectivity, furthermore it allows the user to share process data over a specific Fieldbus and to configure itself through remote connection via TCP/IP networks.

The user can select and configure a Fieldbus between 4 choices:

- EtherNet/IP
- MODBUS/TCP
- PROFINET
- EtherCAT

From a fieldbus point of view MOSAIC M1S COM is always considered as a slave device. The Process Data Mapping document 8547780 is available at: <https://www.reersafety.com/> in the manuals download area.

Process Data Map come into two versions:

1. Process Data Map without analog data
2. Process Data Map with analog data

The user can choose if send or not analog data as process data. If the user choose to include analog data into process map then he must be sure that:

1. At least one MA4 or MA2 analog input module is present into the MOSAIC configuration
2. The process data map supports analog data.

Following the main characteristic supported by each Fieldbus protocol.

Fieldbus	DHCP support	DNS support	TCP/IP connectivity
EtherNet/IP	Yes	Yes	Yes
MODBUS/TCP	Yes	No	Yes
PROFINET	No	No	Yes
EtherCAT	No	No	Yes*

\* Only if EoE option is properly enabled and configured.

When TCP/IP network is available the user can configure MOSAIC M1S COM and perform Monitor through remote connection with MSD software.

The data exchanged with MSD (when TCP/IP network connection is used) are protected against malicious sniffing with an AES 128 bit encryption.

The AES key is exchanged during the initial phase of connection process with an RSA process with a 1024 bit key.

➔ The MOSAIC system is certified to the maximum safety level envisaged by the applicable industrial safety standards (SIL 3, SILCL 3, PL e, Cat. 4).

MOSAIC M1S COM and MBx in the same project: Fieldbus management

➔ If your project is configured with both MOSAIC M1S COM and MBx module then the Fieldbus management is performed exclusively by MBx module.

## Expansion modules

With the MI8, MI16 and MI12T8 Mosaic expansion units, the number of inputs in the system can be increased to allow more external devices to be connected. The MI12T8 also provides 8 OUT\_TEST outputs.

The MO2 and MO4 Mosaic expansion units provide the system, respectively, with 2 and 4 OSSD (Output Signal Switching Device) pairs for controlling devices connected downstream of the MOSAIC. These modules provides also 2 (MO2) or 4 (MO4) SIL 1/PL c outputs.

The MO4LHCS8 is a safety module with 4 single channel High Current Safety Outputs (2A/channel usable also in pairs) and 4 relative inputs for external feedback contacts (EDM).

The module provides 8 SIL 1/PL c outputs.

The MI802 expansion unit provides 8 inputs, 2 pairs of OSSD outputs and 2 programmable SIL 1/PL c outputs.

The MI8O4 expansion unit provides 8 inputs, 4 single channel OSSD outputs (usable also in pairs) and up to 4 programmable SIL 1/PL c outputs or up to 4 relative inputs for external feedback contacts (EDM).

The MO4L expansion unit provides 4 single channel OSSD outputs (usable also in pairs) and up to 4 programmable SIL 1/PL c outputs or up to 4 relative inputs for external feedback contacts (EDM).

The MR2, MR4 and MR8 Mosaic expansion units provide the system with 2, 4 and 8 N.O. guided contact safety relay outputs, respectively, with the related external relay feedback (N.C. contact).

The expansion units in the MB series permit connection to the most commonly used industrial fieldbus systems for diagnostics and data transmission like Profibus (MBP), Canopen (MBC), Devicenet (MBD), CCLink (MBCCL), Profinet (MBEP), EthernetIP (MBEI), Ethercat (MBEC), Modbus RTU (MBEM).

MBU expansion unit permits connection to devices with a USB port.

The MCT1 and MCT2 expansion units are used to connect the MOSAIC M1, MOSAIC M1S, MOSAIC M1S COM to other slave units installed at a distance (< 50 m). Two MCT units installed at the required distance can be connected using a shielded cable (ReeR MC25, MC50 or other cable with the characteristics set out in the cable data sheet).

The MVO, MV1 and MV2 Mosaic expansion units can be used to control the following (up to PLe):

- Zero speed, Max. speed, Speed range;
- Direction of movement, rotation/translation;

Up to 4 speed thresholds can be set for each logic input (axis).

Each unit incorporates two logic inputs that can be configured using the MSD software and is thus capable of controlling up to two independent axes.

The MOR4 and MOR4S8 are safety expansion units provided with 4 independent safety relay outputs and the corresponding 4 inputs for the external feedback contacts (EDM).

There are two possible output settings (configured using the MSD configuration software).

- Two pairs of connection contacts (2 N.O. contacts per output with 2 corresponding feedback inputs).
- Four independent single connection contacts (1 N.O. contact per output with 4 corresponding feedback inputs).

The MOR4S8 unit has 8 programmable SIL 1/PL c outputs.

The MOS8 and MOS16 have 8 and 16 SIL 1/PL c outputs.

The MA2 provides 2 independent safety analog inputs usable also in pairs.

The MA4 provides 4 independent safety analog inputs usable also in pairs.

---

## MSD software

---

The MSD software is capable of creating complex logics, using logical operators and safety functions such as muting, timer, counters, etc.

All this is performed through an easy and intuitive graphic interface.

The configuration performed on the PC is sent to the master unit via USB or LAN (if MOSAIC M1S COM is used) connection; the file resides in the MOSAIC M1, MOSAIC M1S, MOSAIC M1S COM and can also be saved on the proprietary MCM memory card (accessory). By MCM the configuration can therefore quickly be copied to another master unit.

---

## PRODUCT COMPOSITION

---

The MOSAIC M1, MOSAIC M1S, MOSAIC M1S COM are supplied with:

- Multi-language installation sheet.

➔ **NB:** the rear panel MSC connector and MCM memory can be ordered separately as accessories.

The expansion units are supplied with:

- Multilingual Installation sheet.
- Rear panel MSC connector (not present in the MR2 and MR4 which are connected via terminal blocks only).

➔ **NB:** to install an expansion unit (excluding relays) you will need the MSC connector supplied with the unit plus another MSC for the connection to the MOSAIC M1, MOSAIC M1S or MOSAIC M1S COM.

This can be ordered separately as an accessory.

INSTALLATION

MOSAIC M1, MOSAIC M1S, Expansion Modules mechanical fastening

**⚠ Do not apply power supply before carry out the following operations.**

Fix the MOSAIC system units to a 35mm DIN rail as follows:

1. Connect the same number of "MSC" 5-pole rear panel connectors as the number of units to be installed.
2. Fix the train of connectors thus obtained to the Omega DIN 35mm (EN 5022) rail (hooking them at the top first).
3. Fasten the units to the rail, arranging the contacts on the base of the unit on the respective connector. Press the unit gently until you feel it snap into place.
4. To remove a unit, use a screwdriver to pull down the locking latch on the back of the unit; then lift the unit upwards and pull.

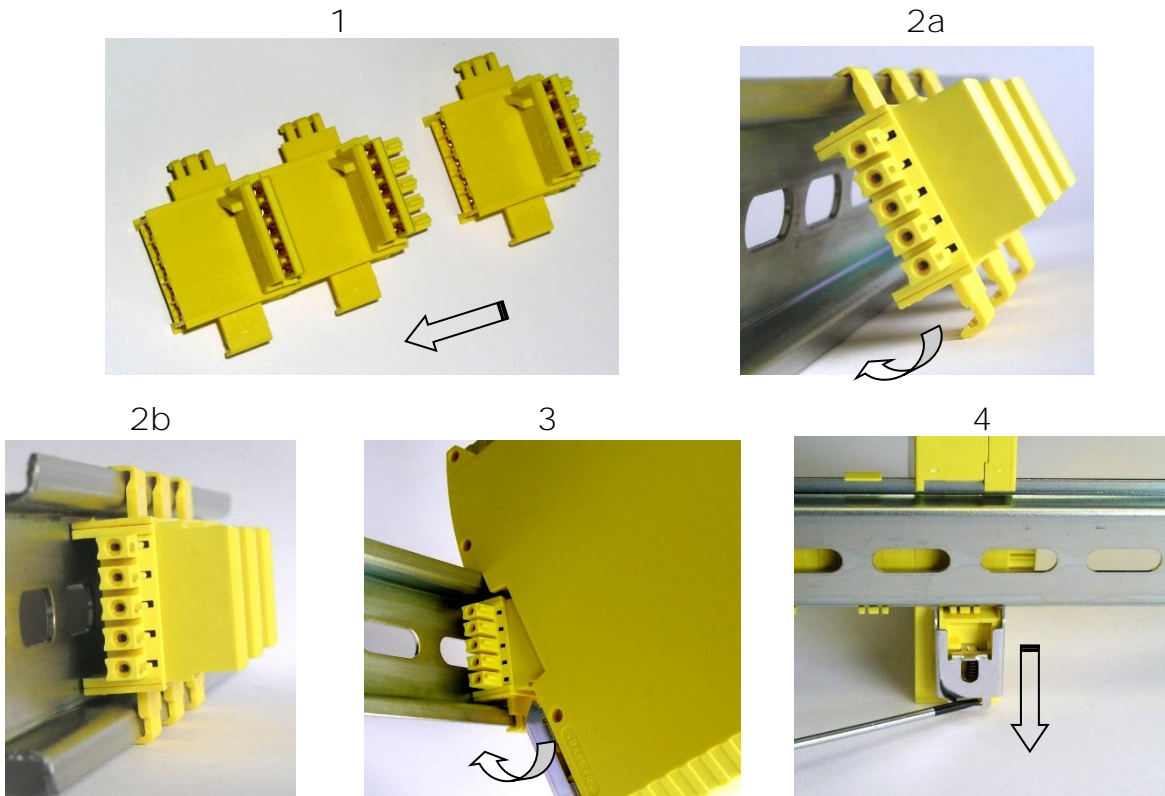



Figure 1



## MOSAIC M1S COM Mechanical fastening

-  Do not apply power supply before carry out the following operations.
-  The off-centre position of the rear connector housing only allows MOSAIC M1S COM to be housed **on the right side** of any other MOSAIC expansion module.

Fix the MOSAIC system units to a 35mm DIN rail as follows:

1. Fix to the Omega DIN 35mm (EN 5022) the same number of "MSC" 5-pole rear panel connectors as the number of units to be installed (hooking them at the top first).
2. Connect between them the connectors just mounted.
3. Fasten the units to the rail, arranging the contacts on the base of the unit on the respective connector. Press the unit gently until you feel it snap into place.
4. To remove a unit, use a screwdriver to pull down the locking latch on the back of the unit; then lift the unit upwards and pull.

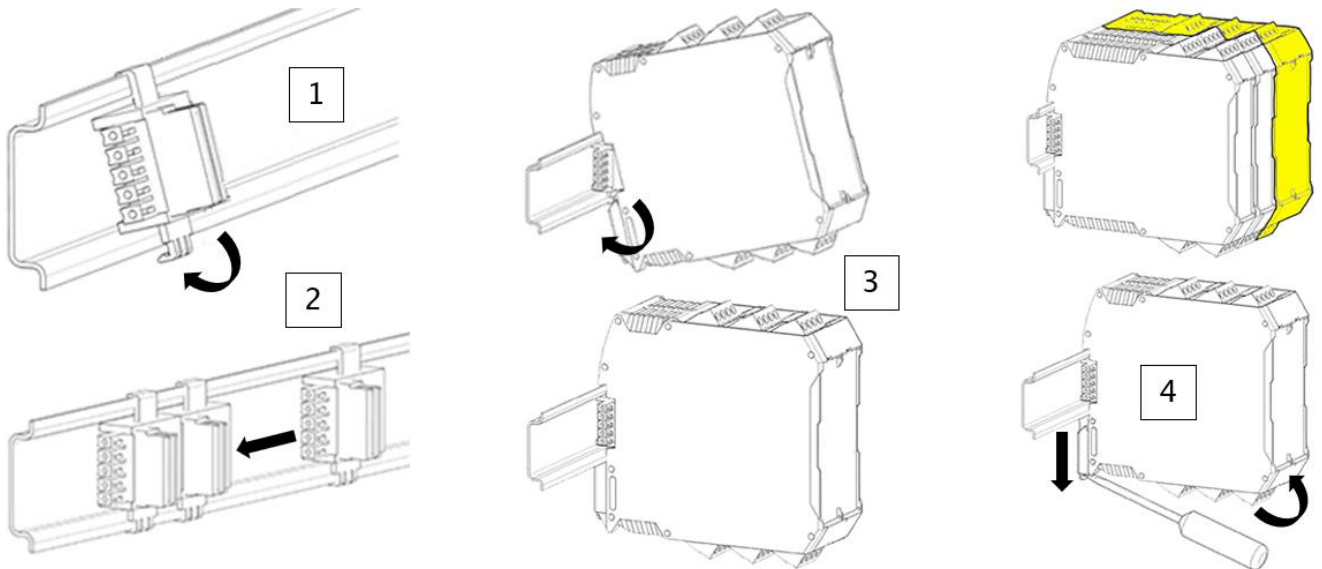

Figure 2

## Calculation of safety distance of an ESPE connected to MOSAIC

Any Electro-sensitive Protective Equipment device connected to MOSAIC, must be positioned at a distance equal to or greater than the minimum safety distance  $S$  so that the dangerous point can be reached only after stopping the dangerous movement of the machine.

- The european standard:**  
 - ISO 13855:2010- (EN 999:2008) *Safety of machinery - Positioning of safeguards with respect to the approach speeds of parts of the human body.*<sup>1</sup> provides the elements to calculate the proper safety distance.
- Carefully read the installation manual of each device for specific information on the correct positioning.**
- Remember that the total response time depends on:**  
 MOSAIC response time + ESPE response time + response time of the machine (i.e. the time taken by the machine to stop the dangerous movement from the moment in which the stop signal is transmitted).

## Electrical connections

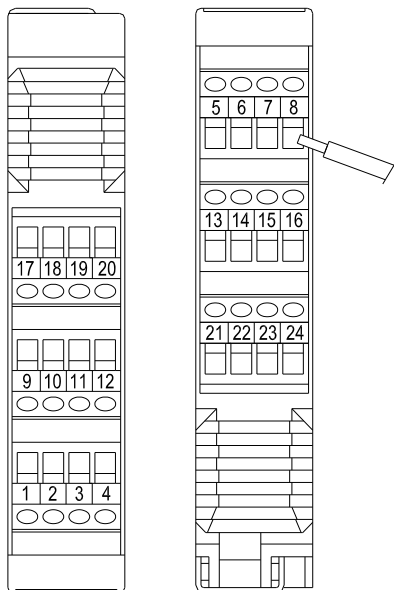

Figure 3

The MOSAIC system units are provided with terminal blocks for the electrical connections. Each unit can have 8, 16 or 24 terminals.

Each unit also has a rear panel plug-in connector (for communication with the master and with the other expansion units).

The MR2, MR4 and MR8 are connected via terminal blocks only.

➔ Terminal tightening torque: 5÷7lb-in (0,6÷0,7 Nm).

- Install safety units in an enclosure with a protection class of at least IP54.**
- Connect the module when it is not powered.**
- The supply voltage to the units must be 24Vdc  $\pm$ 20% (PELV, in compliance with the standard EN 60204-1 (Chapter 6.4)).**
- Do not use the MOSAIC to supply external devices.**

<sup>1</sup> "Describe the methods that designers can use to calculate the minimum safety distance from a specific dangerous point for the safety devices, particularly Electro-sensitive devices (eg. light curtains), safety-mats or pressure sensitive floors and bimanual control. It contains a rule to determine the placement of safety devices based on approach speed and the stopping time of the machine, which can reasonably be extrapolated so that it also includes the interlocking guards without guard locking."

The same ground connection (0VDC) must be used for all system components.

Instructions concerning connection cables

- ➔ Wire size range: AWG 12÷30, (solid/stranded) (UL).
- ➔ Use 60/75°C copper (Cu) conductor only.
- ➔ We recommend the use of separate power supplies for the safety module and for other electrical power equipment (electric motors, inverters, frequency converters) or other sources of disturbance.
- ➔ Cables used for connections of longer than 50m must have a cross-section of at least 1mm<sup>2</sup> (AWG16).

Connections of each single MOSAIC system unit are listed in the table below:

Master Module MOSAIC M1

TERMINAL	SIGNAL	TYPE	DESCRIPTION	OPERATION
1	24VDC	-	24VDC power supply	-
2	MASTER_ENABLE1	Input	Master Enable 1	Input ("type B" according to EN 61131-2)
3	MASTER_ENABLE2	Input	Master Enable 2	Input ("type B" according to EN 61131-2)
4	0VDC	-	0VDC power supply	-
5	OSSD1_A	Output	Static output 1	PNP active high
6	OSSD1_B	Output		PNP active high
7	RESTART_FBK1	Input	Feedback/Restart 1	Input according to EN 61131-2
8	OUT_STATUS1	Output	SIL 1/PL c output	PNP active high
9	OSSD2_A	Output	Static output 2	PNP active high
10	OSSD2_B	Output		PNP active high
11	RESTART_FBK2	Input	Feedback/Restart 2	Input according to EN 61131-2
12	OUT_STATUS2	Output	SIL 1/PL c output	PNP active high
13	OUT_TEST1	Output	Short circuit detection output	PNP active high
14	OUT_TEST2	Output	Short circuit detection output	PNP active high
15	OUT_TEST3	Output	Short circuit detection output	PNP active high
16	OUT_TEST4	Output	Short circuit detection output	PNP active high
17	INPUT1	Input	Digital input 1	Input according to EN 61131-2
18	INPUT2	Input	Digital input 2	Input according to EN 61131-2
19	INPUT3	Input	Digital input 3	Input according to EN 61131-2
20	INPUT4	Input	Digital input 4	Input according to EN 61131-2
21	INPUT5	Input	Digital input 5	Input according to EN 61131-2
22	INPUT6	Input	Digital input 6	Input according to EN 61131-2
23	INPUT7	Input	Digital input 7	Input according to EN 61131-2
24	INPUT8	Input	Digital input 8	Input according to EN 61131-2

Table 2

## Master Modules MOSAIC M1S / MOSAIC M1S COM

TERMINAL	SIGNAL	TYPE	DESCRIPTION	OPERATION
1	24VDC	-	24VDC power supply	-
2	NC	-	-	-
3	NC	-	-	-
4	0VDC	-	0VDC power supply	-
5	OSSD1	Output	Solid State Safety Output 1	PNP active high
6	OSSD2	Output	Solid State Safety Output 2	PNP active high
7	RESTART_FBK1/ STATUS1	Input/ Output	Feedback/Restart 1	Input according to EN 61131-2
			SIL 1/PL c output	PNP active high
8	RESTART_FBK2/ STATUS2	Input/ Output	Feedback/Restart 2	Input according to EN 61131-2
			SIL 1/PL c output	PNP active high
9	OSSD3	Output	Solid State Safety Output 3	PNP active high
10	OSSD4	Output	Solid State Safety Output 4	PNP active high
11	RESTART_FBK3/ STATUS3	Input/ Output	Feedback/Restart 3	Input according to EN 61131-2
			SIL 1/PL c output	PNP active high
12	RESTART_FBK4/ STATUS4	Input/ Output	Feedback/Restart 4	Input according to EN 61131-2
			SIL 1/PL c output	PNP active high
13	OUT_TEST1	Output	Short circuit detection output	PNP active high
14	OUT_TEST2	Output	Short circuit detection output	PNP active high
15	OUT_TEST3	Output	Short circuit detection output	PNP active high
16	OUT_TEST4	Output	Short circuit detection output	PNP active high
17	INPUT1	Input	Digital input 1	Input according to EN 61131-2
18	INPUT2	Input	Digital input 2	Input according to EN 61131-2
19	INPUT3	Input	Digital input 3	Input according to EN 61131-2
20	INPUT4	Input	Digital input 4	Input according to EN 61131-2
21	INPUT5	Input	Digital input 5	Input according to EN 61131-2
22	INPUT6	Input	Digital input 6	Input according to EN 61131-2
23	INPUT7	Input	Digital input 7	Input according to EN 61131-2
24	INPUT8	Input	Digital input 8	Input according to EN 61131-2

Table 3

→ The STATUS SIL 1/PL c outputs are shared with the feedback/restart inputs of the OSSDs. To use them, the corresponding OSSD must be used with automatic reset without external feedback monitoring. For example, to use the STATUS1 output (Terminal 7), you must program OSSD1 (by means of the MSD software) with automatic reset without K feedback monitoring.

**USB interface**

The MOSAIC master MOSAIC M1, MOSAIC M1S, MOSAIC M1S COM include a mini USB 2.0 connector for connection to a Personal Computer where the MSD (MOSAIC Safety Designer) configuration SW resides. A USB cable of the correct size is available as an accessory (CSU).

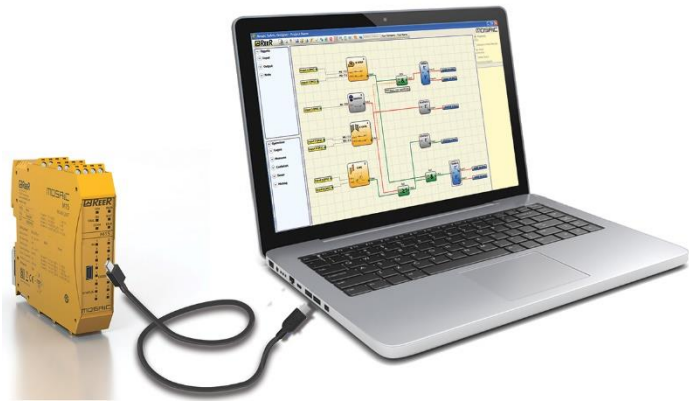

Figure 4 - USB 2.0 front panel connector

**LAN interface (RJ45)**

The MOSAIC master MOSAIC M1S COM include double RJ45 connectors for connection to a Personal Computer via TCP/IP LAN network.



Figure 5 - RJ45 front panel connector

**MOSAIC Configuration Memory (MCM)**

A backup memory, called MCM (optional) can be installed in the MOSAIC master MOSAIC M1, MOSAIC M1S, MOSAIC M1S COM and used to save the SW configuration parameters.

The MCM is written each time a new project is sent from the PC to the MOSAIC M1.

➔ Always switch the MOSAIC M1, MOSAIC M1S, MOSAIC M1S COM off before logging on to/logging off from the MCM.

Insert the card in the slot in the rear panel of the MOSAIC M1, MOSAIC M1S, MOSAIC M1S COM (in the direction shown in Figure 6 - MCM)

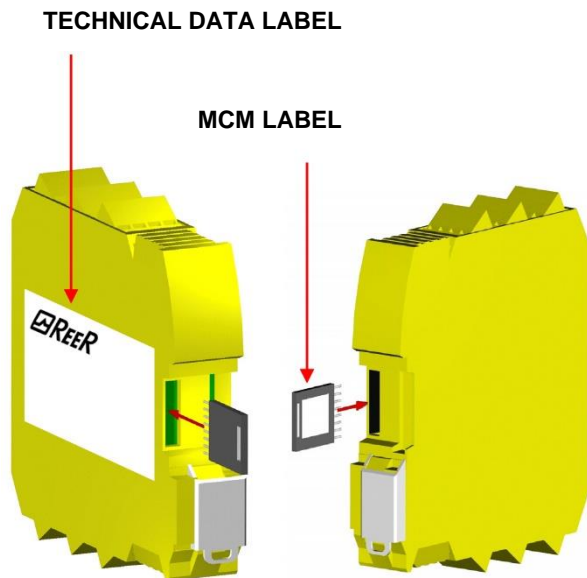



Figure 6 - MCM

**MULTIPLE LOAD function**

To perform the configuration of several master modules without using a PC and the USB connector, you can save the desired configuration on a single MCM and then use it to download data on the masters modules to be configured simply inserting the MCM into the module and turning it on.

 If the file contained in the MCM is not identical to the one contained in MOSAIC M1/MOSAIC M1S/MOSAIC M1S COM, an overwrite operation that will permanently delete the configuration data contained in MOSAIC M1, MOSAIC M1S, MOSAIC M1S COM will be performed. In this case the module blinks fast leds COM and ENABLE.

**WARNING: ALL DATA PREVIOUSLY CONTAINED IN MOSAIC M1, MOSAIC M1S, MOSAIC M1S COM WILL BE LOST.**

### *RESTORE function*

If the Master unit is damaged, you can replace it with a new one; having already saved all the configurations on the MCM, all you need to do is insert the MCM in the new MOSAIC M1, MOSAIC M1S, MOSAIC M1S COM and switch on the MOSAIC system, that will immediately load the backup configuration. In this way, the work interruptions will be minimized.

#### Compatibility between MCM memory and Master modules:

MOSAIC M1S COM can load configurations from MCM if it is written by a MOSAIC M1S COM or MOSAIC M1S or MOSAIC M1.

 Pay attention: A configuration written with MOSAIC M1S COM cannot be read from MOSAIC M1.

MOSAIC M1S can load configurations from MCM if it is written by a MOSAIC M1S or MOSAIC M1

 Pay attention: A configuration written with MOSAIC M1S cannot be read from MOSAIC M1.

 The LOAD and RESTORE functions can be disabled via SW. (see Figure 59)

 Each time MCM is used, carefully check that the chosen configuration is the one that was planned for that particular system. Try again a fully functional test of the system composed of Mosaic plus all devices connected to it (see the "TESTING the system" section).

Module MI802

TERMINAL	SIGNAL	TYPE	DESCRIPTION	OPERATION
1	24VDC	-	24VDC power supply	-
2	NODE_SELO	Input	Node selection	Input ("type B" according to EN 61131-2)
3	NODE_SEL1	Input		Input ("type B" according to EN 61131-2)
4	OVDC	-	OVDC power supply	-
5	OSSD1_A	Output	Static output 1	PNP active high
6	OSSD1_B	Output		PNP active high
7	RESTART_FBK1	Input	Feedback/Restart 1	Input according to EN 61131-2
8	OUT_STATUS1	Output	SIL 1/PL c output	PNP active high
9	OSSD2_A	Output	Static output 2	PNP active high
10	OSSD2_B	Output		PNP active high
11	RESTART_FBK2	Input	Feedback/Restart 2	Input according to EN 61131-2
12	OUT_STATUS2	Output	SIL 1/PL c output	PNP active high
13	OUT_TEST1	Output	Short circuit detection output	PNP active high
14	OUT_TEST2	Output	Short circuit detection output	PNP active high
15	OUT_TEST3	Output	Short circuit detection output	PNP active high
16	OUT_TEST4	Output	Short circuit detection output	PNP active high
17	INPUT1	Input	Digital input 1	Input according to EN 61131-2
18	INPUT2	Input	Digital input 2	Input according to EN 61131-2
19	INPUT3	Input	Digital input 3	Input according to EN 61131-2
20	INPUT4	Input	Digital input 4	Input according to EN 61131-2
21	INPUT5	Input	Digital input 5	Input according to EN 61131-2
22	INPUT6	Input	Digital input 6	Input according to EN 61131-2
23	INPUT7	Input	Digital input 7	Input according to EN 61131-2
24	INPUT8	Input	Digital input 8	Input according to EN 61131-2

Table 4

## Module MI804

TERMINAL	SIGNAL	TYPE	DESCRIPTION	OPERATION
1	24VDC	-	24VDC power supply	-
2	NODE_SELO	-	Node selection	Input ("type B" according to EN 61131-2)
3	NODE_SEL1	-		Input ("type B" according to EN 61131-2)
4	0VDC	-	0VDC power supply	-
5	OSSD1	Output	Solid State Safety Output 1	PNP active high
6	OSSD2	Output	Solid State Safety Output 2	PNP active high
7	RESTART_FBK1/ STATUS1	Input/ Output	Feedback/Restart 1	Input according to EN 61131-2
			SIL 1/PL c output	PNP active high
8	RESTART_FBK2/ STATUS2	Input/ Output	Feedback/Restart 2	Input according to EN 61131-2
			SIL 1/PL c output	PNP active high
9	OSSD3	Output	Solid State Safety Output 3	PNP active high
10	OSSD4	Output	Solid State Safety Output 4	PNP active high
11	RESTART_FBK3/ STATUS3	Input/ Output	Feedback/Restart 3	Input according to EN 61131-2
			SIL 1/PL c output	PNP active high
12	RESTART_FBK4/ STATUS4	Input/ Output	Feedback/Restart 4	Input according to EN 61131-2
			SIL 1/PL c output	PNP active high
13	OUT_TEST1	Output	Short circuit detection output	PNP active high
14	OUT_TEST2	Output	Short circuit detection output	PNP active high
15	OUT_TEST3	Output	Short circuit detection output	PNP active high
16	OUT_TEST4	Output	Short circuit detection output	PNP active high
17	INPUT1	Input	Digital input 1	Input according to EN 61131-2
18	INPUT2	Input	Digital input 2	Input according to EN 61131-2
19	INPUT3	Input	Digital input 3	Input according to EN 61131-2
20	INPUT4	Input	Digital input 4	Input according to EN 61131-2
21	INPUT5	Input	Digital input 5	Input according to EN 61131-2
22	INPUT6	Input	Digital input 6	Input according to EN 61131-2
23	INPUT7	Input	Digital input 7	Input according to EN 61131-2
24	INPUT8	Input	Digital input 8	Input according to EN 61131-2

Table 5

 The STATUS SIL 1/PL c outputs are shared with the FEEDBACK/RESTART inputs of the OSSDs. To use them, the corresponding OSSD must be used with automatic reset without external feedback monitoring. For instance, to use the STATUS1 output (Terminal 7), you must program OSSD1 with automatic reset without K feedback monitoring.



Module MI8

TERMINAL	SIGNAL	TYPE	DESCRIPTION	OPERATION
1	24VDC	-	24VDC power supply	-
2	NODE_SELO	Input	Node selection	Input ("type B" according to EN 61131-2)
3	NODE_SEL1	Input		Input ("type B" according to EN 61131-2)
4	OVDC	-	OVDC power supply	-
5	INPUT1	Input	Digital input 1	Input according to EN 61131-2
6	INPUT2	Input	Digital input 2	Input according to EN 61131-2
7	INPUT3	Input	Digital input 3	Input according to EN 61131-2
8	INPUT4	Input	Digital input 4	Input according to EN 61131-2
9	OUT_TEST1	Output	Short circuit detection output	PNP active high
10	OUT_TEST2	Output	Short circuit detection output	PNP active high
11	OUT_TEST3	Output	Short circuit detection output	PNP active high
12	OUT_TEST4	Output	Short circuit detection output	PNP active high
13	INPUT5	Input	Digital input 5	Input according to EN 61131-2
14	INPUT6	Input	Digital input 6	Input according to EN 61131-2
15	INPUT7	Input	Digital input 7	Input according to EN 61131-2
16	INPUT8	Input	Digital input 8	Input according to EN 61131-2

Table 6

Module MI12T8

TERMINAL	SIGNAL	TYPE	DESCRIPTION	OPERATION
1	24VDC	-	24VDC power supply	-
2	NODE_SELO	Input	Node selection	Input ("type B" according to EN 61131-2)
3	NODE_SEL1	Input		Input ("type B" according to EN 61131-2)
4	OVDC	-	OVDC power supply	-
5	INPUT1	Input	Digital input 1	Input according to EN 61131-2
6	INPUT2	Input	Digital input 2	Input according to EN 61131-2
7	INPUT3	Input	Digital input 3	Input according to EN 61131-2
8	INPUT4	Input	Digital input 4	Input according to EN 61131-2
9	OUT_TEST1	Output	Short circuit detection output	PNP active high
10	OUT_TEST2	Output	Short circuit detection output	PNP active high
11	OUT_TEST3	Output	Short circuit detection output	PNP active high
12	OUT_TEST4	Output	Short circuit detection output	PNP active high
13	INPUT5	Input	Digital input 5	Input according to EN 61131-2
14	INPUT6	Input	Digital input 6	Input according to EN 61131-2
15	INPUT7	Input	Digital input 7	Input according to EN 61131-2
16	INPUT8	Input	Digital input 8	Input according to EN 61131-2
17	OUT_TEST5	Output	Short circuit detection output	PNP active high
18	OUT_TEST6	Output	Short circuit detection output	PNP active high
19	OUT_TEST7	Output	Short circuit detection output	PNP active high
20	OUT_TEST8	Output	Short circuit detection output	PNP active high
21	INPUT9	Input	Digital input 9	Input according to EN 61131-2
22	INPUT10	Input	Digital input 10	Input according to EN 61131-2
23	INPUT11	Input	Digital input 11	Input according to EN 61131-2
24	INPUT12	Input	Digital input 12	Input according to EN 61131-2

Table 7

## Module MI16

TERMINAL	SIGNAL	TYPE	DESCRIPTION	OPERATION
1	24VDC	-	24VDC power supply	-
2	NODE_SELO	Input	Node selection	Input ("type B" according to EN 61131-2)
3	NODE_SEL1	Input		Input ("type B" according to EN 61131-2)
4	0VDC	-	0VDC power supply	-
5	INPUT1	Input	Digital input 1	Input according to EN 61131-2
6	INPUT2	Input	Digital input 2	Input according to EN 61131-2
7	INPUT3	Input	Digital input 3	Input according to EN 61131-2
8	INPUT4	Input	Digital input 4	Input according to EN 61131-2
9	OUT_TEST1	Output	Short circuit detection output	PNP active high
10	OUT_TEST2	Output	Short circuit detection output	PNP active high
11	OUT_TEST3	Output	Short circuit detection output	PNP active high
12	OUT_TEST4	Output	Short circuit detection output	PNP active high
13	INPUT5	Input	Digital input 5	Input according to EN 61131-2
14	INPUT6	Input	Digital input 6	Input according to EN 61131-2
15	INPUT7	Input	Digital input 7	Input according to EN 61131-2
16	INPUT8	Input	Digital input 8	Input according to EN 61131-2
17	INPUT9	Input	Digital input 9	Input according to EN 61131-2
18	INPUT10	Input	Digital input 10	Input according to EN 61131-2
19	INPUT11	Input	Digital input 11	Input according to EN 61131-2
20	INPUT12	Input	Digital input 12	Input according to EN 61131-2
21	INPUT13	Input	Digital input 13	Input according to EN 61131-2
22	INPUT14	Input	Digital input 14	Input according to EN 61131-2
23	INPUT15	Input	Digital input 15	Input according to EN 61131-2
24	INPUT16	Input	Digital input 16	Input according to EN 61131-2

Table 8

## Module MO2

TERMINAL	SIGNAL	TYPE	DESCRIPTION	OPERATION
1	24VDC	-	24VDC power supply	-
2	NODE_SELO	Input	Node selection	Input ("type B" according to EN 61131-2)
3	NODE_SEL1	Input		Input ("type B" according to EN 61131-2)
4	0VDC	-	0VDC power supply	-
5	OSSD1_A	Output	Static output 1	PNP active high
6	OSSD1_B	Output		PNP active high
7	RESTART_FBK1	Input	Feedback/Restart 1	Input according to EN 61131-2
8	OUT_STATUS1	Output	SIL 1/PL c	PNP active high
9	OSSD2_A	Output	Static output 2	PNP active high
10	OSSD2_B	Output		PNP active high
11	RESTART_FBK2	Input	Feedback/Restart 2	Input according to EN 61131-2
12	OUT_STATUS2	Output	SIL 1/PL c	PNP active high
13	24VDC	-	24VDC power supply	24VDC power supply *
14	n.c.	-	-	-
15	0VDC	-	0VDC power supply	0VDC *
16	n.c.	-	-	-

Table 9

➔ \* This terminal must be connected to the power supply for the unit to work properly.

Module MO4

TERMINAL	SIGNAL	TYPE	DESCRIPTION	OPERATION
1	24VDC	-	24VDC power supply	-
2	NODE_SELO	Input	Node selection	Input ("type B" according to EN 61131-2)
3	NODE_SEL1	Input		Input ("type B" according to EN 61131-2)
4	0VDC	-	0VDC power supply	-
5	OSSD1_A	Output	Static output 1	PNP active high
6	OSSD1_B	Output		PNP active high
7	RESTART_FBK1	Input	Feedback/Restart 1	Input according to EN 61131-2
8	OUT_STATUS1	Output	SIL 1/PL c	PNP active high
9	OSSD2_A	Output	Static output 2	PNP active high
10	OSSD2_B	Output		PNP active high
11	RESTART_FBK2	Input	Feedback/Restart 2	Input according to EN 61131-2
12	OUT_STATUS2	Output	SIL 1/PL c	PNP active high
13	24VDC	-	24VDC power supply	24VDC outputs power supply *
14	24VDC	-	24VDC power supply	-
15	0VDC	-	0VDC power supply	0VDC outputs *
16	0VDC	-	0VDC power supply	-
17	OSSD4_A	Output	Static output 4	PNP active high
18	OSSD4_B	Output		PNP active high
19	RESTART_FBK4	Input	Feedback/Restart 4	Input according to EN 61131-2
20	OUT_STATUS4	Output	SIL 1/PL c	PNP active high
21	OSSD3_A	Output	Static output 3	PNP active high
22	OSSD3_B	Output		PNP active high
23	RESTART_FBK3	Input	Feedback/Restart 3	Input according to EN 61131-2
24	OUT_STATUS3	Output	SIL 1/PL c	PNP active high

Table 10

**➔ \* This terminal must be connected to the power supply for the unit to work properly.**

Module MO4L

TERMINAL	SIGNAL	TYPE	DESCRIPTION	OPERATION
1	24VDC	-	24VDC power supply	-
2	NODE_SELO	-	Node selection	Input ("type B" according to EN 61131-2)
3	NODE_SEL1	-		Input ("type B" according to EN 61131-2)
4	0VDC	-	0VDC power supply	-
5	OSSD1	Output	Solid State Safety Output 1	PNP active high
6	OSSD2	Output	Solid State Safety Output 2	PNP active high
7	RESTART_FBK1/ STATUS1	Input/ Output	Feedback/Restart 1	Input according to EN 61131-2
			SIL 1/PL c	PNP active high
8	RESTART_FBK2/ STATUS2	Input/ Output	Feedback/Restart 2	Input according to EN 61131-2
			SIL 1/PL c	PNP active high
9	OSSD3	Output	Solid State Safety Output 3	PNP active high
10	OSSD4	Output	Solid State Safety Output 4	PNP active high
11	RESTART_FBK3/ STATUS3	Input/ Output	Feedback/Restart 3	Input according to EN 61131-2
			SIL 1/PL c	PNP active high
12	RESTART_FBK4/ STATUS4	Input/ Output	Feedback/Restart 4	Input according to EN 61131-2
			SIL 1/PL c	PNP active high

Table 11

➔ The STATUS SIL 1/PL c signal outputs are shared with the FEEDBACK/RESTART inputs of the OSSDs. To use them, the corresponding OSSD must be used with automatic reset without external feedback monitoring.

## Module MR2

TERMINAL	SIGNAL	TYPE	DESCRIPTION	OPERATION
1	24VDC	-	24VDC power supply	-
4	0VDC	-	0VDC power supply	-
5	OSSD1_A	Input	Control ZONE 1	PNP active high
6	OSSD1_B	Input		
7	FBK_K1_K2_1	Output	Feedback K1K2 ZONE 1	
9	A_NC1	Output	NC contact ZONE 1	
10	B_NC1	Output		
13	A_NO11	Output	NO1 contact ZONE 1	
14	B_NO11	Output		
15	A_NO12	Output	NO2 contact ZONE 1	
16	B_NO12	Output		

Table 12

## Module MR4

TERMINAL	SIGNAL	TYPE	DESCRIPTION	OPERATION
1	24VDC	-	24VDC power supply	-
4	0VDC	-	0VDC power supply	-
5	OSSD1_A	Input	Control ZONE 1	PNP active high
6	OSSD1_B	Input		
7	FBK_K1_K2_1	Output	Feedback K1K2 ZONE 1	
9	A_NC1	Output	NC contact ZONE 1	
10	B_NC1	Output		
13	A_NO11	Output	NO1 contact ZONE 1	
14	B_NO11	Output		
15	A_NO12	Output	NO2 contact ZONE 1	
16	B_NO12	Output		
11	A_NC2	Output	NC contact ZONE 2	
12	B_NC2	Output		
17	OSSD2_A	Input	Control ZONE 2	PNP active high
18	OSSD2_B	Input		
19	FBK_K1_K2_2	Output	Feedback K1K2 ZONE 2	
21	A_NO21	Output	NO1 contact ZONE 2	
22	B_NO21	Output		
23	A_NO22	Output	NO2 contact ZONE 2	
24	B_NO22	Output		

Table 13

Module MR8

TERMINAL	SIGNAL	TYPE	DESCRIPTION	OPERATION
1	24VDC	-	24VDC power supply	-
4	GND	-	0VDC power supply	-
5	OSSD1_A	Input	Control ZONE 1	PNP active high
6	OSSD1_B	Input		
7	FBK_K1_K2_1_1	Output	Feedback K1K2 ZONE 1	Normally closed EDM
8	FBK_K1_K2_1_2	Output		
9	A_NC1	Output	NC contact ZONE 1	Normally closed
10	B_NC1	Output		
13	A_NO11	Output	NO1 contact ZONE 1	Normally opened
14	B_NO11	Output		
15	A_NO12	Output	NO2 contact ZONE 1	Normally opened
16	B_NO12	Output		
11	A_NC2	Output	NC contact ZONE 2	Normally closed
12	B_NC2	Output		
17	OSSD2_A	Input	Control ZONE 2	PNP active high
18	OSSD2_B	Input		
19	FBK_K1_K2_2_1	Output	Feedback K1K2 ZONE 2	Normally closed EDM
20	FBK_K1_K2_2_2	Output		
21	A_NO21	Output	NO1 contact ZONE 2	Normally opened
22	B_NO21	Output		
23	A_NO22	Output	NO2 contact ZONE 2	Normally opened
24	B_NO22	Output		
25	24VDC	-	24VDC power supply	-
28	GND	-	0VDC power supply	-
29	OSSD3_A	Input	Control ZONE 3	PNP active high
30	OSSD3_B	Input		
31	FBK_K1_K2_3_1	Output	Feedback K1K2 ZONE 3	Normally closed EDM
32	FBK_K1_K2_3_2	Output		
33	A_NC3	Output	NC contact ZONE 3	Normally closed
34	B_NC3	Output		
37	A_NO31	Output	NO1 contact ZONE 3	Normally opened
38	B_NO31	Output		
39	A_NO32	Output	NO2 contact ZONE 3	Normally opened
40	B_NO32	Output		
35	A_NC4	Output	NC contact ZONE 4	Normally closed
36	B_NC4	Output		
41	OSSD4_A	Input	Control ZONE 4	PNP active high
42	OSSD4_B	Input		
43	FBK_K1_K2_4_1	Output	Feedback K1K2 ZONE 4	Normally closed EDM
44	FBK_K1_K2_4_2	Output		
45	A_NO41	Output	NO1 contact ZONE 4	Normally opened
46	B_NO41	Output		
47	A_NO42	Output	NO2 contact ZONE 4	Normally opened
48	B_NO42	Output		

Table 14

## Modules MVO - MV1 - MV2

TERMINAL	SIGNAL	TYPE	DESCRIPTION	OPERATION
1	24VDC	-	24VDC power supply	-
2	NODE_SELO	Input	Node selection	Input ("type B" according to EN 61131-2)
3	NODE_SEL1	Input		Input ("type B" according to EN 61131-2)
4	OVDC	-	OVDC power supply	-
5	PROXI1_24V	Output	PROXIMITY 1 connections (ref. "PROXIMITY INPUT FOR SPEED CONTROLLER MV2"->39)	Power supply 24VDC to PROXI1
6	PROXI1_REF	Output		Power supply 0VDC to PROXI1
7	PROXI1 IN1 (3 WIRES)	Input		PROXI1 NO input
8	PROXI1 IN2 (4 WIRES)	Input		PROXI1 NC input
9	PROXI2_24V	Output	PROXIMITY 2 connections (ref. "PROXIMITY INPUT FOR SPEED CONTROLLER MV2"->39)	Power supply 24VDC to PROXI2
10	PROXI2_REF	Output		Power supply 0VDC to PROXI2
11	PROXI2 IN1 (3 WIRES)	Input		PROXI2 NO input
12	PROXI2 IN2 (4 WIRES)	Input		PROXI2 NC input
13	N.C.	-	Not connected	-
14	N.C.	-		-
15	N.C.	-		-
16	N.C.	-		-

Table 15

## Encoder connections with RJ45 connector (MV1, MV2)

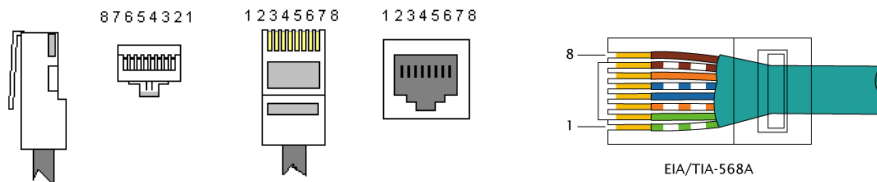

PIN		MVT	MVTB	MVH	MVS
TWISTED *	1	5VDC	N.C.	N.C.	N.C.
	2	EXT_OV	EXT_OV	EXT_OV	EXT_OV
	3	N.C.	N.C.	N.C.	N.C.
TWISTED *	4	A	A	A	A
	5	$\bar{A}$	$\bar{A}$	$\bar{A}$	$\bar{A}$
TWISTED *	6	N.C.	N.C.	N.C.	N.C.
	7	B	B	B	B
	8	$\bar{B}$	$\bar{B}$	$\bar{B}$	$\bar{B}$

\* IN CASE OF UTILIZATION OF TWISTED CABLE

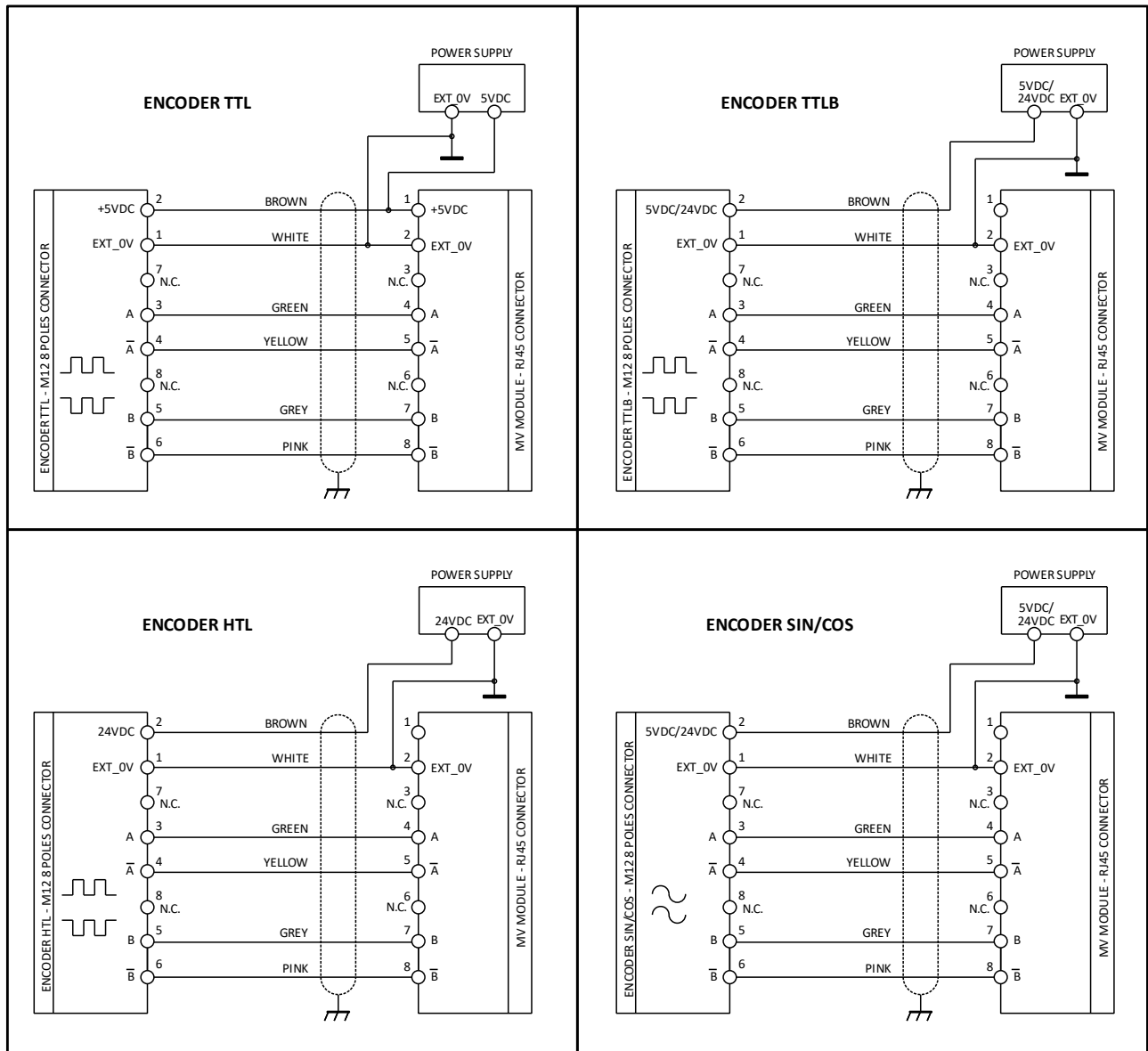

Figure 7

## Module MOR4

TERMINAL	SIGNAL	TYPE	DESCRIPTION	OPERATION
1	24VDC	-	24VDC power supply	-
2	NODE_SELO	Input	Node selection	Input (" <b>type B</b> " according to EN 61131-2)
3	NODE_SEL1	Input		Input (" <b>type B</b> " according to EN 61131-2)
4	OVDC	-	OVDC power supply	-
5	REST_FBK1	Input	Feedback/Restart 1	Input (according EN 61131-2)
6	REST_FBK2	Input	Feedback/Restart 2	Input (according EN 61131-2)
7	REST_FBK3	Input	Feedback/Restart 3	Input (according EN 61131-2)
8	REST_FBK4	Input	Feedback/Restart 4	Input (according EN 61131-2)
9	A_NO1	Output	N.O. contact Channel 1	
10	B_NO1	Output		
11	A_NO2	Output	N.O. contact Channel 2	
12	B_NO2	Output		
13	A_NO3	Output	N.O. contact Channel 3	
14	B_NO3	Output		
15	A_NO4	Output	N.O. contact Channel 4	
16	B_NO4	Output		

Table 16

## Module MOR4S8

TERMINAL	SIGNAL	TYPE	DESCRIPTION	OPERATION
1	24VDC	-	24VDC power supply	-
2	NODE_SELO	Input	Node selection	Input (" <b>type B</b> " according to EN 61131-2)
3	NODE_SEL1	Input		Input (" <b>type B</b> " according to EN 61131-2)
4	OVDC	-	OVDC power supply	-
5	REST_FBK1	Input	Feedback/Restart 1	Input (according EN 61131-2)
6	REST_FBK2	Input	Feedback/Restart 2	Input (according EN 61131-2)
7	REST_FBK3	Input	Feedback/Restart 3	Input (according EN 61131-2)
8	REST_FBK4	Input	Feedback/Restart 4	Input (according EN 61131-2)
9	A_NO1	Output	N.O. contact Channel 1	
10	B_NO1	Output		
11	A_NO2	Output	N.O. contact Channel 2	
12	B_NO2	Output		
13	A_NO3	Output	N.O. contact Channel 3	
14	B_NO3	Output		
15	A_NO4	Output	N.O. contact Channel 4	
16	B_NO4	Output		
17	SYS_STATUS1	Output	SIL 1/PL c	PNP active high
18	SYS_STATUS2	Output	SIL 1/PL c	PNP active high
19	SYS_STATUS3	Output	SIL 1/PL c	PNP active high
20	SYS_STATUS4	Output	SIL 1/PL c	PNP active high
21	SYS_STATUS5	Output	SIL 1/PL c	PNP active high
22	SYS_STATUS6	Output	SIL 1/PL c	PNP active high
23	SYS_STATUS7	Output	SIL 1/PL c	PNP active high
24	SYS_STATUS8	Output	SIL 1/PL c	PNP active high

Table 17



Module MOS8

PIN	SIGNAL	TYPE	DESCRIPTION	OPERATION
1	24VDC	-	24VDC power supply	-
2	NODE_SELO	Input	Node selection	Input (" <b>type B</b> " according to EN 61131-2)
3	NODE_SEL1	Input		Input (" <b>type B</b> " according to EN 61131-2)
4	0VDC	-	0VDC power supply	-
5	24VDC STATUS 1-8	-	24VDC power supply OUT_STATUS 1-8	-
6	-	-	-	-
7	-	-	-	-
8	-	-	-	-
9	OUT_STATUS1	Output	SIL 1/PL c	PNP active high
10	OUT_STATUS2	Output	SIL 1/PL c	PNP active high
11	OUT_STATUS3	Output	SIL 1/PL c	PNP active high
12	OUT_STATUS4	Output	SIL 1/PL c	PNP active high
13	OUT_STATUS5	Output	SIL 1/PL c	PNP active high
14	OUT_STATUS6	Output	SIL 1/PL c	PNP active high
15	OUT_STATUS7	Output	SIL 1/PL c	PNP active high
16	OUT_STATUS8	Output	SIL 1/PL c	PNP active high

Table 18

Module MOS16

PIN	SIGNAL	TYPE	DESCRIPTION	OPERATION
1	24VDC	-	24VDC power supply	-
2	NODE_SELO	Input	Node selection	Input (" <b>type B</b> " according to EN 61131-2 )
3	NODE_SEL1	Input		Input (" <b>type B</b> " according to EN 61131-2 )
4	0VDC	-	0VDC power supply	-
5	24VDC STATUS 1-8	-	24VDC power supply for OUT_STATUS 1...8	-
6	24VDC STATUS 9-16	-	24VDC power supply for OUT_STATUS 9...16	-
7	-	-	-	-
8	-	-	-	-
9	OUT_STATUS1	Output	SIL 1/PL c	PNP active high
10	OUT_STATUS2	Output	SIL 1/PL c	PNP active high
11	OUT_STATUS3	Output	SIL 1/PL c	PNP active high
12	OUT_STATUS4	Output	SIL 1/PL c	PNP active high
13	OUT_STATUS5	Output	SIL 1/PL c	PNP active high
14	OUT_STATUS6	Output	SIL 1/PL c	PNP active high
15	OUT_STATUS7	Output	SIL 1/PL c	PNP active high
16	OUT_STATUS8	Output	SIL 1/PL c	PNP active high
17	OUT_STATUS9	Output	SIL 1/PL c	PNP active high
18	OUT_STATUS10	Output	SIL 1/PL c	PNP active high
19	OUT_STATUS11	Output	SIL 1/PL c	PNP active high
20	OUT_STATUS12	Output	SIL 1/PL c	PNP active high
21	OUT_STATUS13	Output	SIL 1/PL c	PNP active high
22	OUT_STATUS14	Output	SIL 1/PL c	PNP active high
23	OUT_STATUS15	Output	SIL 1/PL c	PNP active high
24	OUT_STATUS16	Output	SIL 1/PL c	PNP active high

Table 19

## Module MO4LHCS8

PIN	SIGNAL	TYPE	DESCRIPTION	OPERATION
1	24VDC	-	24VDC power supply	-
2	NODE_SEL0	Input	Node selection	Input (" <b>type B</b> " according to EN 61131-2)
3	NODE_SEL1	Input		Input (" <b>type B</b> " according to EN 61131-2)
4	0VDC	-	0VDC power supply	-
5	REST_FBK1	Input	Feedback/Restart 1	Input (according EN 61131-2)
6	REST_FBK2	Input	Feedback/Restart 2	Input (according EN 61131-2)
7	REST_FBK3	Input	Feedback/Restart 3	Input (according EN 61131-2)
8	REST_FBK4	Input	Feedback/Restart 4	Input (according EN 61131-2)
9	OSSD1	Output	Safety Output 1	PNP active high 4 single channels (or 2 dual channels)
10	OSSD2	Output	Safety Output 2	
11	OSSD3	Output	Safety Output 3	
12	OSSD4	Output	Safety Output 4	
13	-	-	-	-
14	24 VDC	-	24VDC power supply	-
15	-	-	-	-
16	-	-	-	-
17	OUT_STATUS1	Output	SIL 1/PL c	PNP active high
18	OUT_STATUS2	Output	SIL 1/PL c	PNP active high
19	OUT_STATUS3	Output	SIL 1/PL c	PNP active high
20	OUT_STATUS4	Output	SIL 1/PL c	PNP active high
21	OUT_STATUS5	Output	SIL 1/PL c	PNP active high
22	OUT_STATUS6	Output	SIL 1/PL c	PNP active high
23	OUT_STATUS7	Output	SIL 1/PL c	PNP active high
24	OUT_STATUS8	Output	SIL 1/PL c	PNP active high

Table 20

## Modulo MA2

PIN	SIGNAL	TYPE	DESCRIPTION	OPERATION
1	24 VDC	-	24VDC power supply	-
2	NODE_SEL0	Input	Node selection	Input ("type B" according to EN 61131-2)
3	NODE_SEL1	Input		Input ("type B" according to EN 61131-2)
4	0 VDC	-	0VDC power supply	-
9	24VDC_S1	Output	Sensor 1 Connections	Isolated 24VDC power supply for sensor 1
10	IN_S1	Input		4/20mA sensor 1 Input
	NEG_S1	Input		0/10V sensor 1 negative input
11	OUT_S1	Output		4/20mA sensor 1 Output
	POS_S1	Input		0/10V sensor 1 positive input
12	0 VDC_S1	Output		Isolated 0VDC reference for sensor 1
13	24VDC_S2	Output	Sensor 2 Connections	Isolated 24VDC power supply for sensor 2
14	IN_S2	Input		4/20mA sensor 2 Input
	NEG_S2	Input		0/10V sensor 2 negative input
15	OUT_S2	Output		4/20mA sensor 2 Output
	POS_S2	Input		0/10V sensor 2 positive input
16	0 VDC_S2	Output		Isolated 0VDC reference for sensor 2

Table 21

Modulo MA4

PIN	SIGNAL	TYPE	DESCRIPTION	OPERATION
1	24 VDC	-	24VDC power supply	-
2	NODE_SEL0	Input	Node selection	Input ("type B" according to EN 61131-2)
3	NODE_SEL1	Input		Input ("type B" according to EN 61131-2)
4	0 VDC	-	0VDC power supply	-
9	24VDC_S1	Output	Sensor 1 Connections	Isolated 24VDC power supply for sensor 1
10	IN_S1	Input		4/20mA sensor 1 Input
	NEG_S1	Input		0/10V sensor 1 negative input
11	OUT_S1	Output		4/20mA sensor 1 Output
	POS_S1	Input		0/10V sensor 1 positive input
12	0 VDC_S1	Output		Isolated 0VDC reference for sensor 1
13	24VDC_S3	Output	Sensor 3 Connections	Isolated 24VDC power supply for sensor 3
14	IN_S3	Input		4/20mA sensor 3 Input
	NEG_S3	Input		0/10V sensor 3 negative input
15	OUT_S3	Output		4/20mA sensor 3 Output
	POS_S3	Input		0/10V sensor 3 positive input
16	0 VDC_S3	Output		Isolated 0VDC reference for sensor 3
17	24VDC_S2	Output	Sensor 2 Connections	Isolated 24VDC power supply for sensor 2
18	IN_S2	Input		4/20mA sensor 2 Input
	NEG_S2	Input		0/10V sensor 2 negative input
19	OUT_S2	Output		4/20mA sensor 2 Output
	POS_S2	Input		0/10V sensor 2 positive input
20	0 VDC_S2	Output		Isolated 0VDC reference for sensor 2
21	24VDC_S4	Output	Sensor 4 Connections	Isolated 24VDC power supply for sensor 4
22	IN_S4	Input		4/20mA sensor 4 Input
	NEG_S4	Input		0/10V sensor 4 negative input
23	OUT_S4	Output		4/20mA sensor 4 Output
	POS_S4	Input		0/10V sensor 4 positive input
24	0 VDC_S4	Output		Isolated 0VDC reference for sensor 4

Table 22

**MA2 / MA4 Analog sensor connections**

The MA2/MA4 modules are suitable for:

- 4/20mA current output sensors with 2/3/4 wires
- 0/20mA current output sensors with 2/3/4 wires
- 0/10V voltage output sensors with 3 wires

Following are shown some connections example:

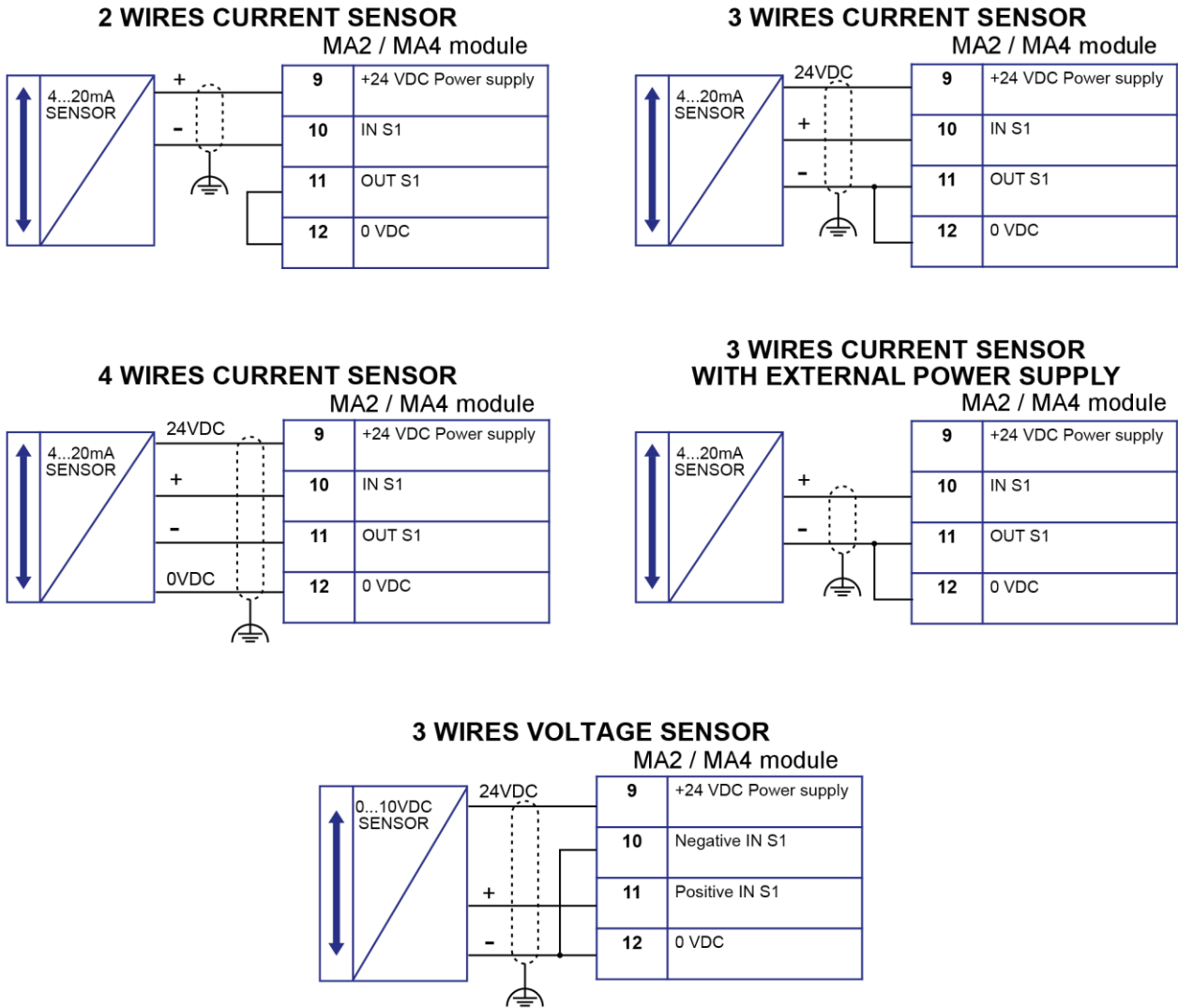

Figure 8

- ⚡ If shielded cables are not used or if the shield connection to PE is not properly wired then electromagnetic disturbance could cause signal corruption. A corrupted signal could lead to unexpected behavior of the module which as a consequence could lead to potentially severe damage to people or things.
- ⚡ If the sensor connections are not correct or if the type of sensor connected to the input is incorrect (for example a voltage sensor connected to a current input and vice versa), the functionality of the module is not more guaranteed.
- ⚡ Perform a complete system TEST (see "TESTING the system").

Example of connection of Mosaic to the machine control system

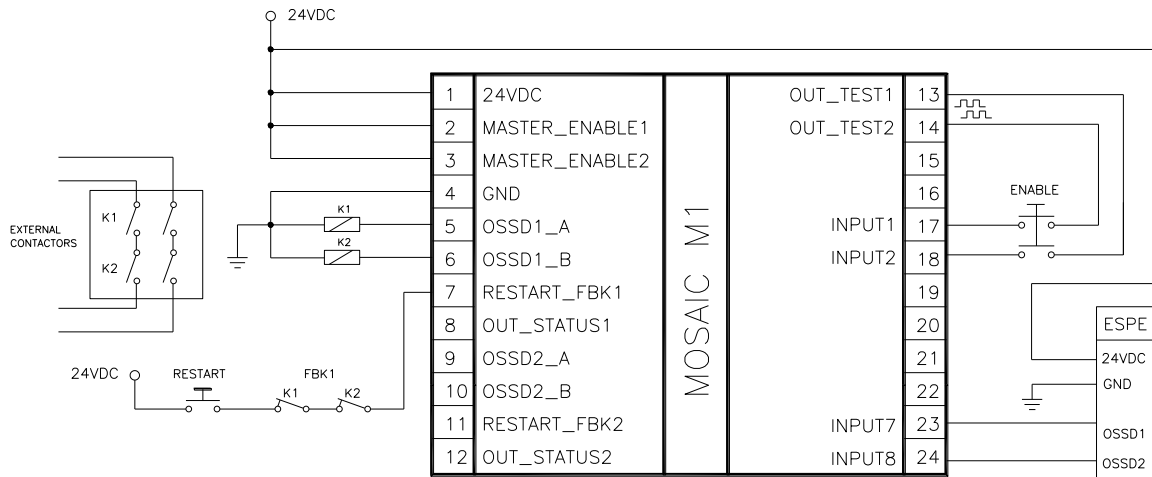

Figure 9

Checklist after installation

The MOSAIC system is able to detect the faults that occurs in each own module. Anyway to have the system perfect operation perform the following checks at start up and at least every one year:

1. Operate a complete system TEST (see "TESTING the system")
2. Verify that all the cables are correctly inserted and the terminal blocks well screwed.
3. Verify that all the leds (indicators) light on correctly.
4. Verify the positioning of all the sensors connected to MOSAIC.
5. Verify the correct fixing of MOSAIC to the Omega rail.
6. Verify that all the external indicators (lamps) work properly.

➔ After installation, maintenance and after any eventual configuration change perform a System TEST as described in the paragraph "Testing the system".

OPERATING DIAGRAM

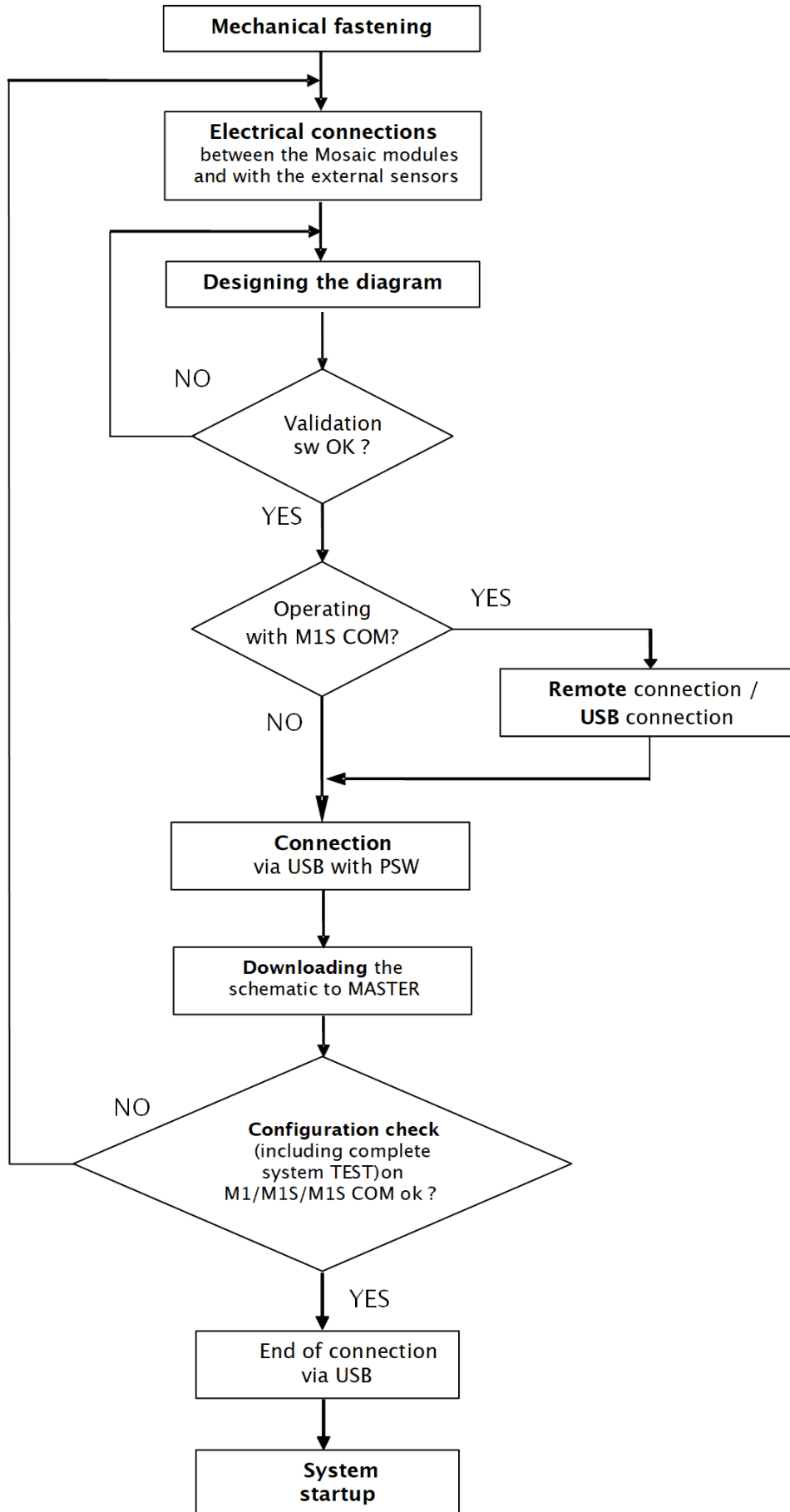

# SIGNALS

## INPUTS

### MASTER ENABLE

The MOSAIC M1 master has two inputs: MASTER\_ENABLE1 and MASTER\_ENABLE2.

- ➔ These signals must **both be permanently set** to logic level 1 (24VDC) for the MOSAIC to operate. If the user needs to disable the MOSAIC simply lower these inputs to logic level 0 (0VDC).
- ➔ These input are not present on MOSAIC M1S and MOSAIC M1S COM which are always enabled.

### NODE SEL

The NODE\_SELO and NODE\_SEL1 inputs (on the SLAVE units) are used to attribute a physical address to the slave units with the connections shown in Table 23:

	NODE_SEL1 (Terminal 3)	NODE_SELO (Terminal 2)
NODE 0	0 (or not connected)	0 (or not connected)
NODE 1	0 (or not connected)	24VDC
NODE 2	24VDC	0 (or not connected)
NODE 3	24VDC	24VDC

*Table 23*

A maximum of 4 addresses is provided and 4 modules of the same type can be used in the same system.

- ➔ It is not allowed to use the same physical address on two units of the same type.
- ➔ In order to be used, the expansion units must be addressed at the time of installation (see the NODE SEL section).

### PROXIMITY INPUT FOR SPEED CONTROLLER MV

- An inadequate mechanical installation of proximity sensors can cause dangerous operation. Pay particular attention to the size of the phonic wheel and to the mechanical fixing of the sensors.
- In any condition of expected speed, the MVxxx module must be able to detect the speed. During the installation (and then periodically) perform a complete system test. By using the MSD software or by checking that the LEDs relating to the sensors are lit, make sure that the module does not detect any anomalies in any case.
- The sizing of the exciter and the positioning of the sensors must be done following the technical data of the latter and the manufacturer’s guidelines.
- Pay particular attention to Common Cause Failures (CCF) that may involve both sensors (short circuit of cables, objects falling from above, idle rotation of the phonic wheel, etc.)

**Configuration With Interleaved Proximity**

When an axis of the MV modules is configured for a measurement with two proximity switches, these can be configured in interleaved mode. Under the conditions listed below the system reaches a Performance Level = PLe:

- Proximity switches must be fitted such that the recorded signals overlap.
- Proximity switches must be fitted such that at least one is always activated.

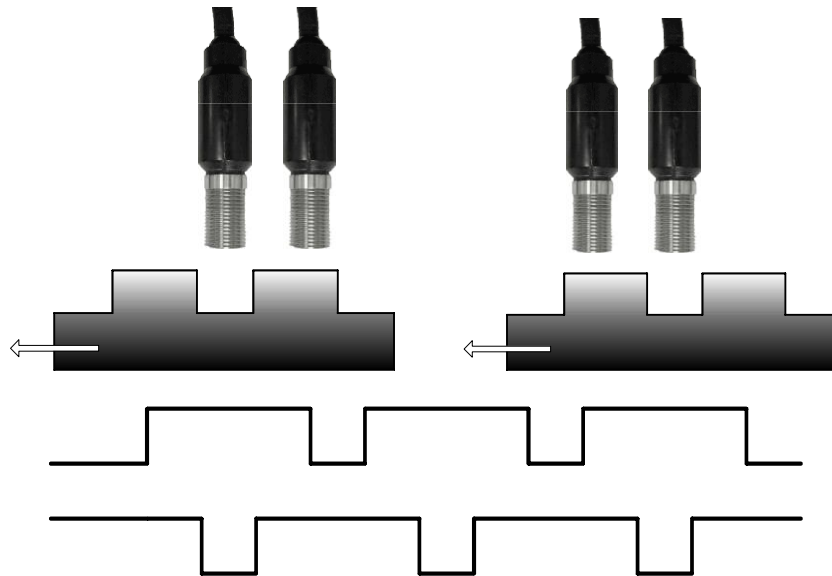

Figure 10

In addition:

- The proximity switches must be PNP type.
- The proximity switches must be NO type (Output ON when detecting metal).
- With the above conditions fulfilled, the DC value is equal to 90%.
- The two proximity switches must be of the same model, with MTTF > 70 years.

**RESTART\_FBK**

The RESTART\_FBK signal input allows the MOSAIC to verify an EDM (External Device Monitoring) feedback signal (series of contacts) from the external contactors, and to monitor Manual/Automatic operation (See the list of possible connections in Table 24).

- ⚠ If the application requires it, the response time of the external contactors must be verified by an additional device.
- ⚠ The RESTART command must be installed outside the danger area in a position where the danger area and the entire work area concerned are clearly visible.
- ⚠ It must not be possible to reach the control from inside the danger area.



MODE OF OPERATION	EDM	RESTART_FBK
AUTOMATIC	With K1_K2 control	
	Without K1_K2 control	
MANUAL	With K1_K2 control	
	Without K1_K2 control	

Table 24

## OUTPUTS

### OUT STATUS (SIL 1/PL c)

The OUT STATUS signal is a Programmable SIL 1 /PL c output that can indicate the status of:

- An input.
- An output.
- A node of the logic diagram designed using the MSD.

### OUT TEST

The OUT TEST signals must be used to monitor the presence of short-circuits or overloads on the inputs (Figure 11).

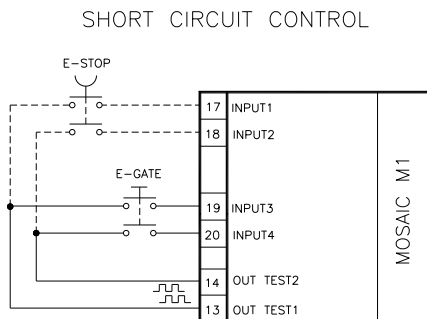

Figure 11

- ➔ The maximum number of controllable inputs for each output OUT TEST is 4 INPUTS (parallel connection)
- ➔ The maximum allowed length for OUT TEST signal connections is = 100m.

OSSD SAFETY OUTPUTS

*Important note concerning OSSD Safety Outputs*

➔ OSSD safety outputs are periodically tested against possible stuck to 0V or +24VDC or against bad cabling (e.g. two OSSD outputs shorted together). The test method chosen to perform this safety check is the “voltage dip” test: periodically (every: MOSAIC M1: 20 ms; MOSAIC M1S and MOSAIC M1S COM: 600 ms) and for a very short time (< 120 μs) each OSSD output is forced to 0VDC and if the test results are not consistent the system goes in fail and into a safe state.

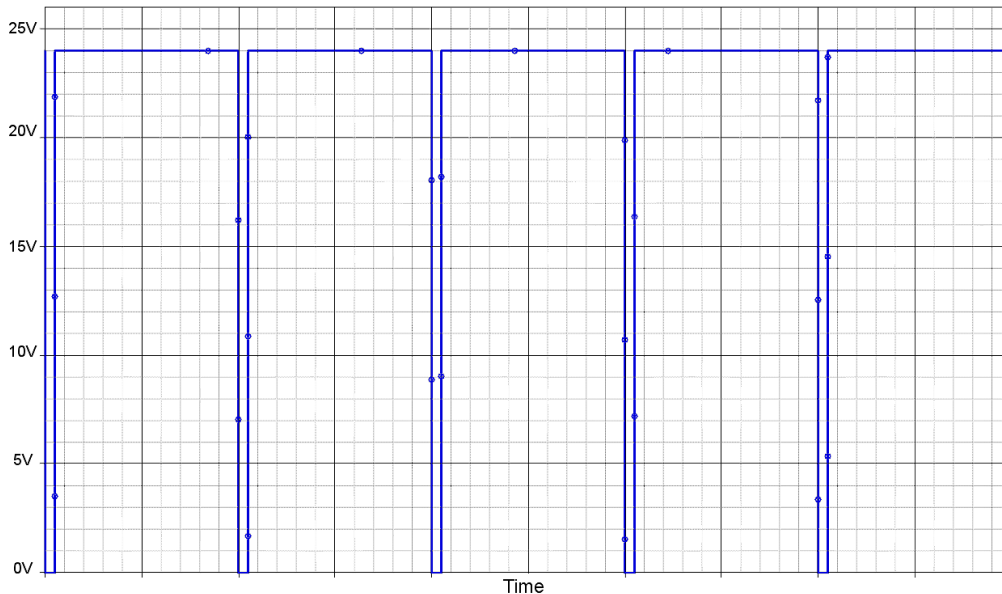

Figure 12 - Voltage dip test

OSSD (MOSAIC M1, MI8O2, MO2, MO4)

The MOSAIC M1, MI8O2, MO2, MO4 modules are equipped with OSSD (**static semiconductor safety outputs**) dual channel. These outputs are short circuit protected, cross circuit monitored and supply:

- In the ON condition: (Uv-0,75V)...Uv (**24VDC ± 20%**)
- In the OFF condition: 0V...2V r.m.s.

The maximum load of 400mA@24V corresponds to a minimum resistive load of 60Ω.

The maximum capacitive load is 0.68 μF. The maximum inductive load is 2 mH.

➔ External devices cannot be connected to the outputs unless explicitly planned in the MSD program configuration.

OSSD (MOSAIC M1S, MOSAIC M1S COM, MI8O4, MO4L)

The MOSAIC M1S, MOSAIC M1S COM, MI8O4, MO4L modules are equipped with OSSD (**static semiconductor safety outputs**) single channel. These outputs are short circuit protected, cross circuit monitored and supply:

- In the ON condition: (Uv-0,75V)...Uv (**24VDC ± 20%**)
- In the OFF condition: 0V...2V r.m.s.

The maximum load of 400mA@24V corresponds to a minimum resistive load of 60Ω.

The maximum capacitive load is 0.82μF. The maximum inductive load is 2 mH.

Different output configurations (configurable with MSD configuration software) can be set:

- 4 single channels (1 Safety Output per channel with its relative feedback input).
- 2 dual channels (2 Safety Outputs per channel with their relative feedback input).
- 1 dual channel and 2 single channels.

**⚠** Using single channels OSSD, to maintain Safety Integrity Level (SIL) "3" requirements the OSSD outputs must be independent.

**⚠** Common cause failures between OSSD outputs must be excluded by observing an appropriate cable installation (i.e. separate cable paths).

**➔** External devices cannot be connected to the outputs unless explicitly planned in the MSD program configuration.

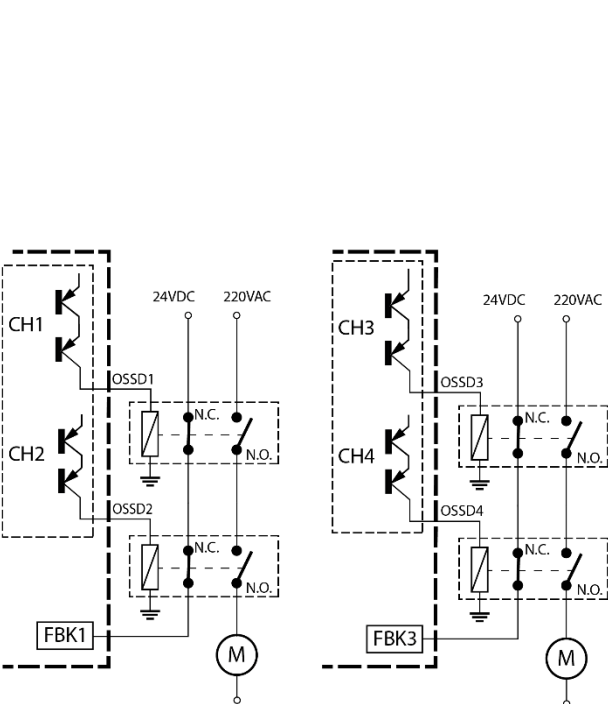
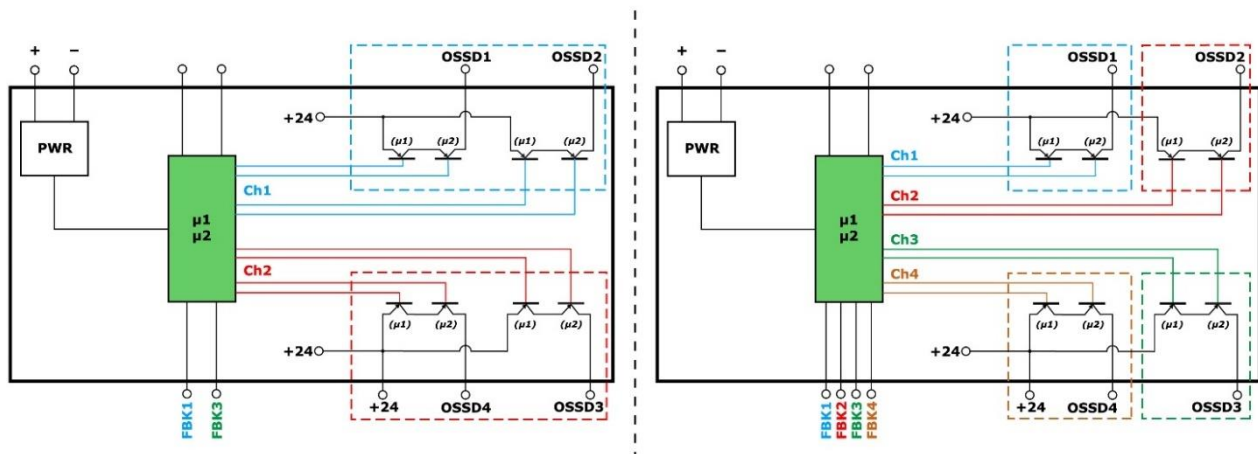

*Configuration with 2 dual channel outputs (safety category SIL3/Pl e)*

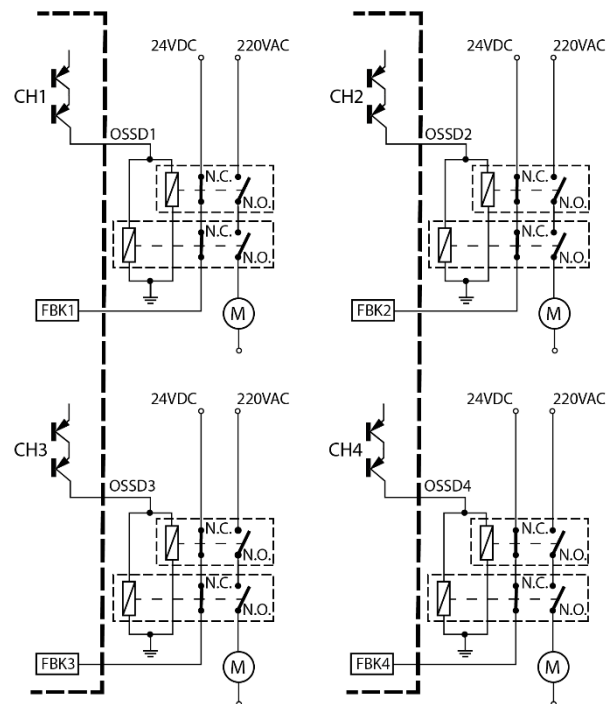

*Configuration with 4 single outputs (safety category SIL3/Pl e)*

OSSD (MO4LHCS8)

MO4LHCS8 provides 4 High Current Safety Outputs single channel (2A max per channel). These outputs are short circuit protected, cross circuit monitored and supply:

- In the ON condition:  $(U_v - 0,6V) \dots U_v$  (**24VDC  $\pm$  20%**)
- In the OFF condition: 0V...2V r.m.s.

The maximum load of 2A@24V corresponds to a minimum resistive load of 12 $\Omega$ .

The maximum capacitive load is 0.82 $\mu$ F. The maximum inductive load is 2.4 mH.

Different output configurations (configurable with MSD configuration software) can be set:

- Four single channels (1 Safety Output per channel with its relative feedback input).
- Two dual channels (2 Safety Outputs per channel with their relative feedback input).
- 1 dual channel and 2 single channels.

- ⚡ Using single channels OSSD, to maintain Safety Integrity Level (SIL) "3" requirements the OSSD outputs must be independent.
- ⚡ Common cause failures between OSSD outputs must be excluded by observing an appropriate cable installation (i.e. separate cable paths).
- ⚡ Using MO4LHCS8 with sum output current > 5 A, then separate adjacent modules by interposing a MSC connector.

➔ External devices cannot be connected to the outputs unless explicitly planned in the MSD program configuration.

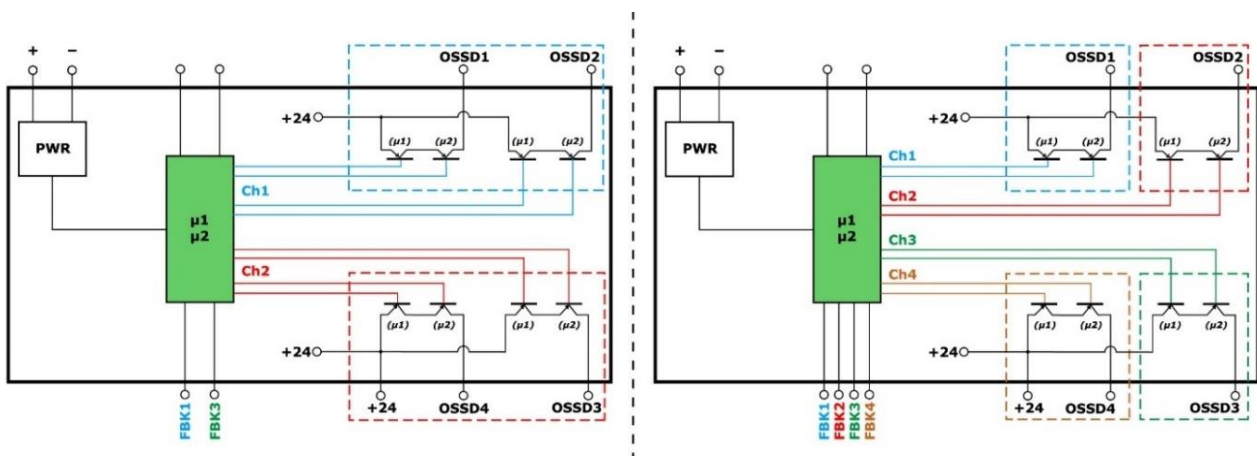

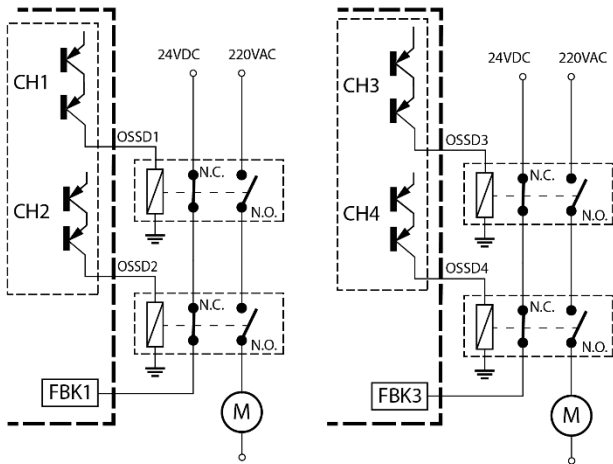

Configuration with 2 dual channel outputs (safety category SIL3/Pl e)

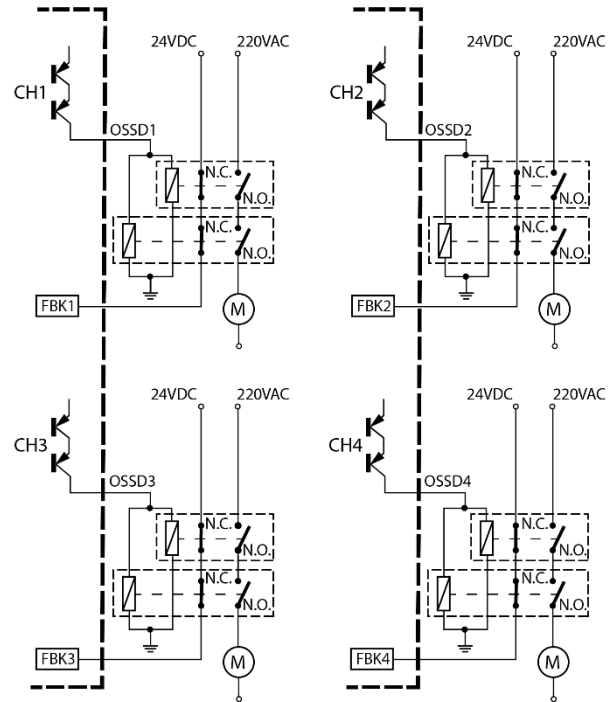

Configuration with 4 single outputs (safety category SIL3/Pl e)

OSSD OUTPUTS CONFIGURATION

Each OSSD output can be configured as shown in Table 25:

Automatic	The output is activated according to le configurations set by the MSD SW only if the corresponding RESTART_FBK input is connected to 24VDC.
Manual	The output is activated according to le configurations set by the MSD SW only if corresponding RESTART_FBK input FOLLOWS A LOGIC TRANSITION OF 0-->1.
Monitored	The output is activated according to le configurations set by the MSD SW only if the corresponding RESTART_FBK input FOLLOWS A LOGIC TRANSITION OF 0-->1-->0.

Table 25

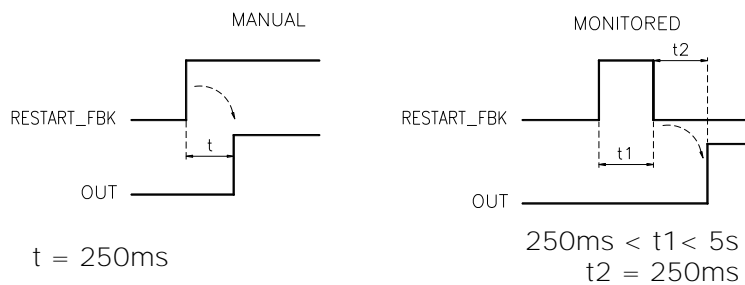

Figure 13

➔ It is not allowed the connection of external devices to the outputs, except as expected in the configuration performed with the MSD software.

SAFETY RELAYS (MR2, MR4, MR8, MOR4, MOR4S8)

**Characteristics of the output circuit**

The MR2/MR4/MR8 units use guided contact safety relays, each of which provides two N.O. contacts and one N.C contact in addition to the N.C. feedback contact. The MR2 unit uses two safety relays, the MR4 uses four and the MR8 uses eight. The MOR4/MOR4S8 units use four guided-contact safety relays. Each relay provides one NO contact monitored by the module logic through internal FBK contact.

➔ Refer to the "RELAY" section to check the possible MOR4/MOR4S8 operation modes configurable with MSD software.

Excitation voltage	17...31 VDC
Minimum switchable voltage	10 VDC
Minimum switchable current	20 mA
Maximum switchable voltage (DC)	250VDC
Maximum switchable voltage (AC)	400VAC
Maximum switchable current	6A
Response time	12ms
Mechanical life of contacts	> 20 x 10 <sup>6</sup>

Table 26

➔ To guarantee correct isolation and avoid the risk of premature ageing of or damage to the relays, each output line must be protected using a fast acting 4A fuse and the load characteristics must be consistent with those specified in Table 12.

➔ See the "Characteristics of the output circuit" section (for further details on these relays).

MR2/MR4/MR8 internal contacts diagram

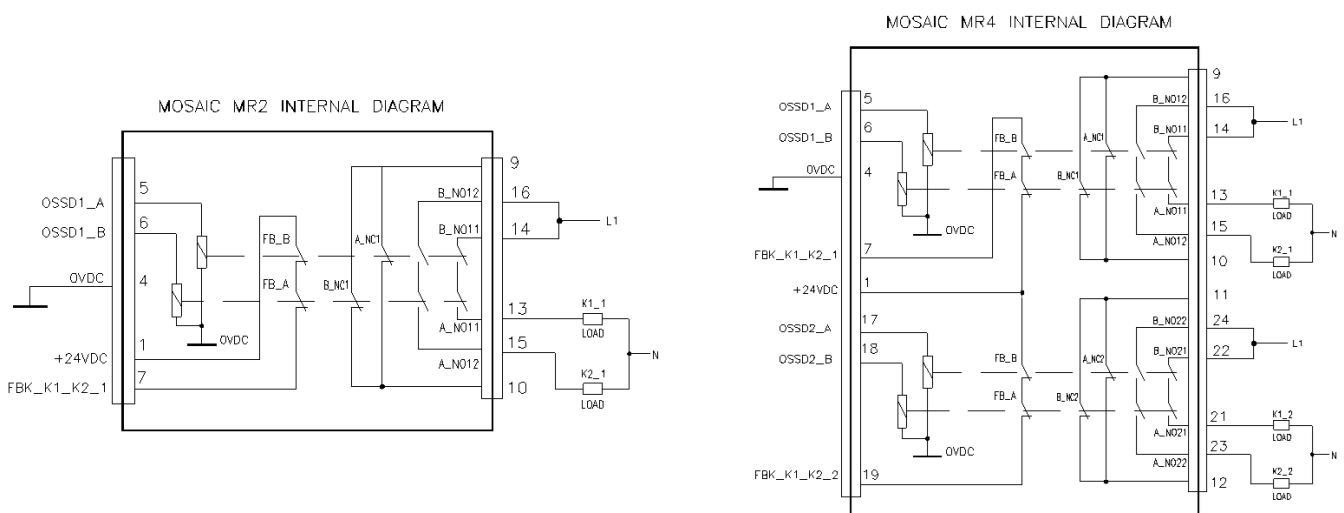

Figure 14



Figura 15

Example of MR2 module connection with static OSSD of a module MOSAIC M1<sup>2</sup>

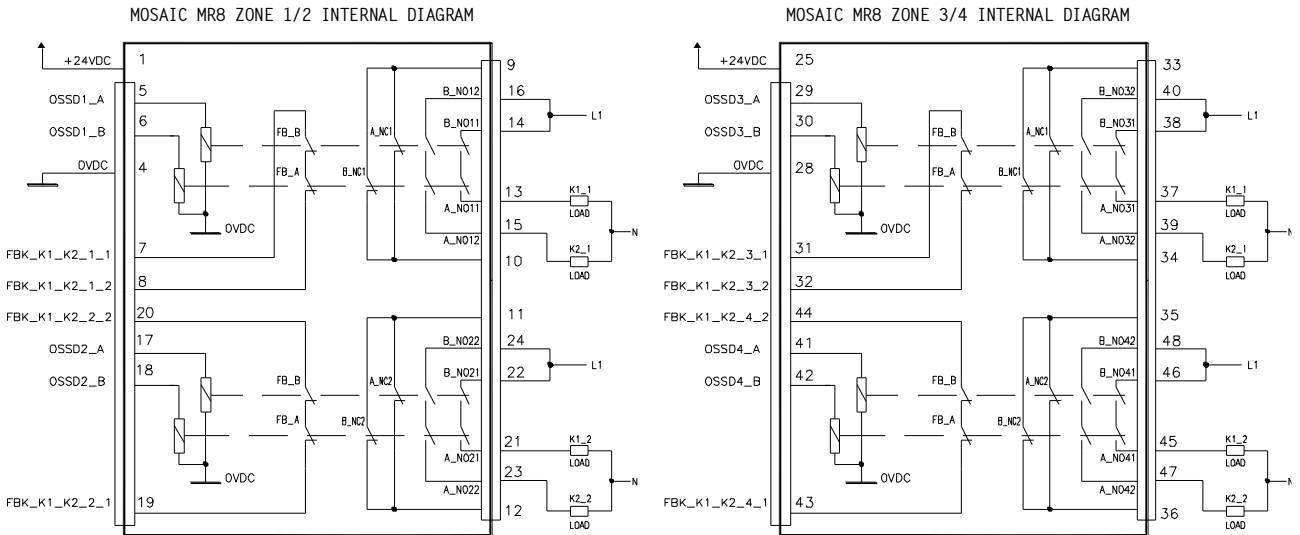
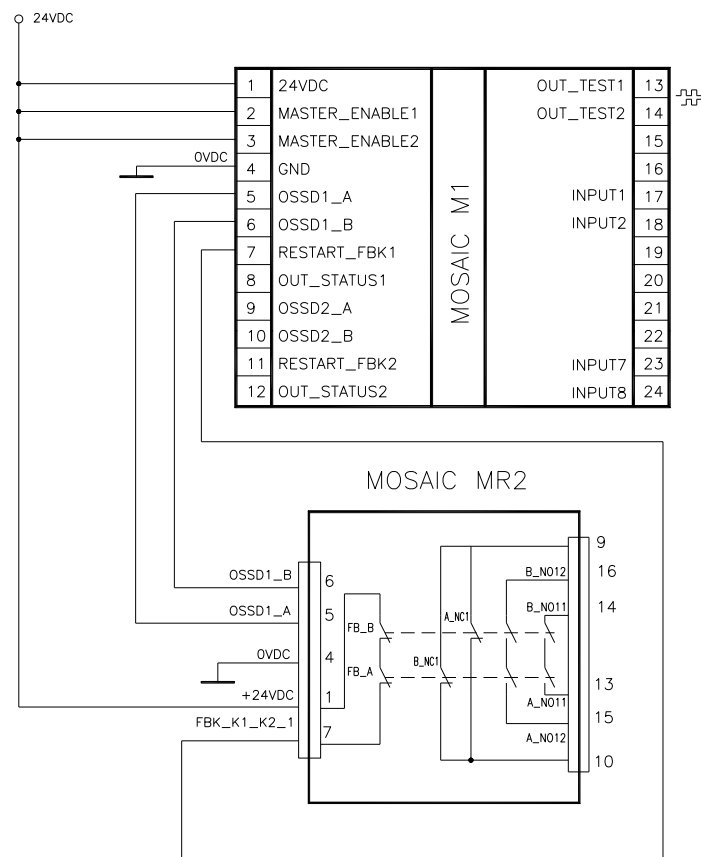

Figure 16

<sup>2</sup> If a relay module is connected, the response time of the OSSD linked, must be increased of 12ms.

Switching operation timing diagram.

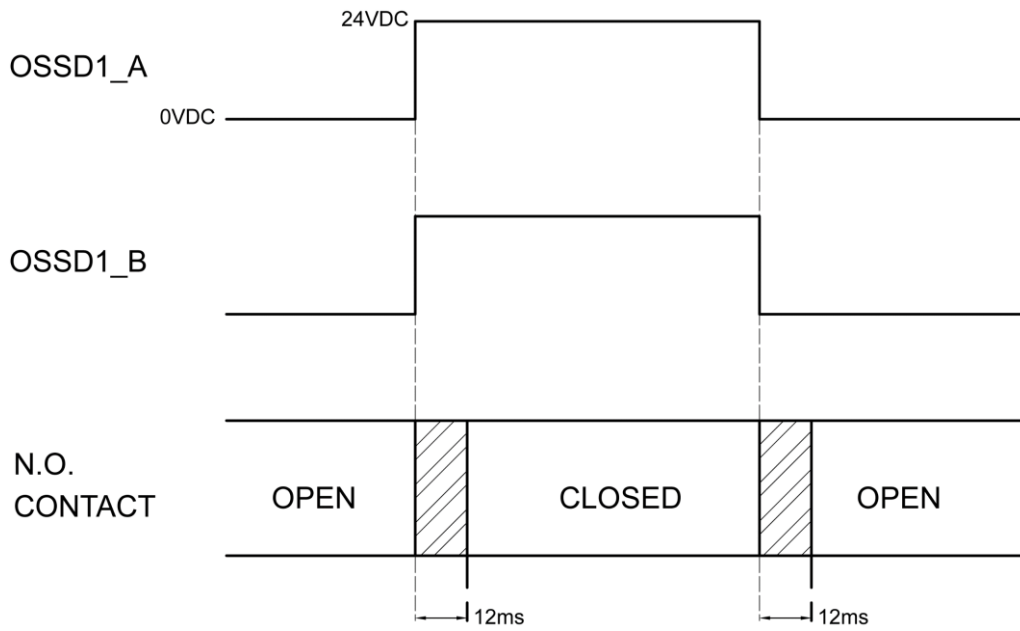

Figure 17



# TECHNICAL FEATURES

## GENERAL SYSTEM CHARACTERISTICS

### Safety level parameters

Parameter	Value	Standard
PFD <sub>d</sub>	See the technical data tables for each module	EN 61508:2010
SFF	See the technical data tables for each module	
SIL	3	
SIL	1 (only MOS8, MOS16)	
HFT	1	
Safety standard	Type B	
SILCL	3	EN 62061:2021
Type	4	EN IEC 61496-1:2020
PL	e	EN ISO 13849-1:2015 EN 62061:2021
PL	c (only MOS8, MOS16)	
D <sub>c</sub> <sub>avg</sub>	High	
MTTF <sub>d</sub> (years)	30...100	
Category	4	
Device lifetime	20 years	
Pollution degree	2	

### General data

Max number of inputs	128	
Max number of OSSD outputs	16 (MOSAIC M1); 32 (MOSAIC M1S)	
Max number of signalling outputs	32 (MOSAIC M1); 48 (MOSAIC M1S/MOSAIC M1S COM)	
Max number of slave units (excluding MR2-MR4, MR8)	14	
Max number of slave units of the same type (excluding MR2-MR4-MR8)	4	
Rated voltage	24VDC ± 20% / PELV, Protective Class III; UL: Supply from class 2 (LVLE)	
Over voltage category	II	
Digital INPUTS	PNP active high (EN 61131-2) – Max. applicable resistance 1,2kΩ	
OSSD (MOSAIC M1, MOSAIC M1S, MOSAIC M1S COM, MI8O2, MI8O4, MO2, MO4, MO4L)	PNP active high - 400mA@24VDC max (each OSSD)	
OSSD (MO4LHCS8)	PNP active high - 2A@24VDC max (each OSSD)	
Relays OUTPUTS (MR2, MR4, MR8, MOR4, MOR4S8)	6A max@240Vac max (each relais)	
SIL1/PL C output (MOSAIC M1, MOSAIC M1S, MOSAIC M1S COM, MI8O2, MI8O4, MO2, MO4, MO4L, MOR4S8, MO4LHCS8, MOS8, MOS16)	PNP active high - 100mA@24VDC max	
Response time MOSAIC M1 (ms)  <i>This response times depends on the following parameters:</i> 1) Number of Slave modules installed 2) Number of Operators 3) Number of OSSD outputs  For the right response time refer to the one calculated by the DSD software (see Project report)	Master MOSAIC M1	10,6...12,6 + T <sub>Input_filter</sub>
	MOSAIC M1 + 1 Slave	11,8...26,5 + T <sub>Input_filter</sub>
	MOSAIC M1 + 2 Slaves	12,8...28,7 + T <sub>Input_filter</sub>
	MOSAIC M1 + 3 Slaves	13,9...30,8 + T <sub>Input_filter</sub>
	MOSAIC M1 + 4 Slaves	15...33 + T <sub>Input_filter</sub>
	MOSAIC M1 + 5 Slaves	16...35 + T <sub>Input_filter</sub>
	MOSAIC M1 + 6 Slaves	17...37,3 + T <sub>Input_filter</sub>
	MOSAIC M1 + 7 Slaves	18,2...39,5 + T <sub>Input_filter</sub>
	MOSAIC M1 + 8 Slaves	19,3...41,7 + T <sub>Input_filter</sub>
	MOSAIC M1 + 9 Slaves	20,4...43,8 + T <sub>Input_filter</sub>
	MOSAIC M1 + 10 Slaves	21,5...46 + T <sub>Input_filter</sub>
	MOSAIC M1 + 11 Slaves	22,5...48,1 + T <sub>Input_filter</sub>
	MOSAIC M1 + 12 Slaves	23,6...50,3 + T <sub>Input_filter</sub>
	MOSAIC M1 + 13 Slaves	24,7...52,5 + T <sub>Input_filter</sub>
	MOSAIC M1 + 14 Slaves	25,8...54,6 + T <sub>Input_filter</sub>
Failure Response time MOSAIC M1 (ms)  This parameter corresponds to the response time, with the exception of MV modules with Encoder/Proximity interface where is 2s		

Response time MOSAIC M1S (ms)  <i>This response times depends on the following parameters:</i> 1) Number of Slave modules installed 2) Number of Operators 3) Number of OSSD outputs  For the right response time refer to the one calculated by the DSD software (see Project report)	Master MOSAIC M1S	12,75...14,75 + T <sub>Input_filter</sub>
	MOSAIC M1S + 1 Slave	13,83...37,84 + T <sub>Input_filter</sub>
	MOSAIC M1S + 2 Slaves	14,91...40,00 + T <sub>Input_filter</sub>
	MOSAIC M1S + 3 Slaves	15,99...42,16 + T <sub>Input_filter</sub>
	MOSAIC M1S + 4 Slaves	17,07...44,32 + T <sub>Input_filter</sub>
	MOSAIC M1S + 5 Slaves	18,15...46,48 + T <sub>Input_filter</sub>
	MOSAIC M1S + 6 Slaves	19,23...48,64 + T <sub>Input_filter</sub>
	MOSAIC M1S + 7 Slaves	20,31...50,80 + T <sub>Input_filter</sub>
	MOSAIC M1S + 8 Slaves	21,39...52,96 + T <sub>Input_filter</sub>
	MOSAIC M1S + 9 Slaves	22,47...55,12 + T <sub>Input_filter</sub>
	MOSAIC M1S + 10 Slaves	23,55...57,28 + T <sub>Input_filter</sub>
	MOSAIC M1S + 11 Slaves	24,63...59,44 + T <sub>Input_filter</sub>
	MOSAIC M1S + 12 Slaves	25,71...61,60 + T <sub>Input_filter</sub>
	MOSAIC M1S + 13 Slaves	26,79...63,76 + T <sub>Input_filter</sub>
	MOSAIC M1S + 14 Slaves	27,87...65,92 + T <sub>Input_filter</sub>
Failure Response time MOSAIC M1S (ms)  <i>This parameter corresponds to the response time, with the exception of MV modules with Encoder/Proximity interface where is 2s</i>	Master MOSAIC M1S COM	13,95...19,95 + T <sub>Input_filter</sub>
	MOSAIC M1S COM + 1 Slave	15,03...40,16 + T <sub>Input_filter</sub>
	MOSAIC M1S COM + 2 Slaves	16,11...42,32 + T <sub>Input_filter</sub>
	MOSAIC M1S COM + 3 Slaves	17,19...44,48 + T <sub>Input_filter</sub>
	MOSAIC M1S COM + 4 Slaves	18,27...46,64 + T <sub>Input_filter</sub>
	MOSAIC M1S COM + 5 Slaves	19,35...48,80 + T <sub>Input_filter</sub>
	MOSAIC M1S COM + 6 Slaves	20,43...50,96 + T <sub>Input_filter</sub>
	MOSAIC M1S COM + 7 Slaves	21,51...53,12 + T <sub>Input_filter</sub>
	MOSAIC M1S COM + 8 Slaves	22,59...55,28 + T <sub>Input_filter</sub>
	MOSAIC M1S COM + 9 Slaves	23,67...57,44 + T <sub>Input_filter</sub>
	MOSAIC M1S COM + 10 Slaves	24,75...59,60 + T <sub>Input_filter</sub>
	MOSAIC M1S COM + 11 Slaves	25,83...61,76 + T <sub>Input_filter</sub>
	MOSAIC M1S COM + 12 Slaves	26,91...63,92 + T <sub>Input_filter</sub>
	MOSAIC M1S COM + 13 Slaves	27,99...66,08 + T <sub>Input_filter</sub>
	MOSAIC M1S COM + 14 Slaves	29,07...68,24 + T <sub>Input_filter</sub>
MOSAIC M1, MOSAIC M1S, MOSAIC M1S COM, -> module connection	Reer proprietary 5-pole bus (MSC)	
Connection cable cross-section	0,5...2,5 mm <sup>2</sup> / AWG 12÷30 (solid/stranded)	
Max length of connections	100m	
Operating temperature	-10...55°C	
Max surrounding air temperature	55°C (UL)	
Storage temperature	-20...85°C	
Relative humidity	10%...95%	
Max. altitude (above sea level)	2000m	
Vibration resistance (EN 61496-1 / class 5M1)	+/- 1.5mm (9...200 Hz)	
Shock resistance (EN 61496 1/ class 3M4)	15 g (6 ms half-sine)	

➔ T<sub>Input\_filter</sub> = max filtering time from among those set on project inputs (see "INPUTS" section).

## Enclosure

Description	Electronic housing max 24 pole, with locking latch mounting
Enclosure material	Polyamide
Enclosure protection class	IP 20
Terminal blocks protection class	IP 2X
Fastening	Quick coupling to rail according to EN 60715
Dimensions (h x l x d)	108 x 22,5 x 114,5 108 x 45 x 114,5 (MOSAIC M1S COM)

**MOSAIC M1 module**

PFH <sub>d</sub> (IEC 61508:2010)	6.85E-9
SFF	99,8%
Rated voltage	24VDC ± 20%
Dissipated power	3W max
Unit enable (No./description)	2 / PNP active high <b>"type B"</b> according to EN 61131-2
Digital INPUTS (No./description)	8 / PNP active high according to EN 61131-2
INPUT FBK/RESTART (No./description)	2 / EDM control / possible Automatic or Manual operation with RESTART button
Test OUTPUT (No./description)	4 / to check for short-circuits - overloads
SIL 1/PL c OUTPUTS (No./description)	2 / programmable - PNP active high
OSSD (No./description)	2 pairs / solid state safety outputs PNP active high 400mA@24VDC max - Interface type C class 3 (ZVEI CB24I)
SLOT for MCM card	Available
Connection to PC	USB 2.0 (Hi Speed) - Max cable length: 3m
Connection to slave units	via MSC 5-way ReeR proprietary bus

**MOSAIC M1S module**

PFH <sub>d</sub> (IEC 61508:2010)	1,44E-08
SFF	99,7%
Rated voltage	24VDC ± 20%
Dissipated power	3W max
Digital INPUTS (No./description)	8 / PNP active high according to EN 61131-2
INPUT FBK/RESTART (No./description)	Up to 4 / EDM control / possible Automatic or Manual operation with RESTART button
Test OUTPUT (No./description)	4 / to check for short-circuits - overloads
SIL 1/PL c OUTPUTS (No./description)	Up to 4 / programmable - PNP active high
OSSD (No./description)	4 single / solid state safety outputs PNP active high 400mA@24VDC max Interface type C class 3 (ZVEI CB24I)
SLOT for MCM card	Available
Connection to PC	USB 2.0 (Hi Speed) - Max cable length: 3m
Connection to slave units	via MSC 5-way ReeR proprietary bus

**MOSAIC M1S COM module**

PFH <sub>d</sub> (IEC 61508:2010)	2,89E-08
SFF	99,4%
Rated voltage	24VDC ± 20%
Dissipated power	4W max
Digital INPUTS (No./description)	8 / PNP active high according to EN 61131-2
INPUT FBK/RESTART (No./description)	Up to 4 / EDM control / possible Automatic or Manual operation with RESTART button
Test OUTPUT (No./description)	4 / to check for short-circuits - overloads
SIL 1/PL c OUTPUTS (No./description)	Up to 4 / programmable - PNP active high
OSSD (No./description)	4 single / solid state safety outputs PNP active high 400mA@24VDC max Interface type C class 3 (ZVEI CB24I)
SLOT for MCM card	Available
USB Connection to PC	USB 2.0 (Hi Speed) - Max cable length: 3m
LAN Connection to PC	Ethernet connection (10/100 Mbit)
Ethernet connection cables category	Cat5 or higher
Ethernet connection max length of connection cables	100 m
Supported fieldbus protocol	EtherNet/IP - MODBUS/TCP - PROFINET - EtherCAT
Connection to slave units	via MSC 5-way ReeR proprietary bus

**MI802 module**

PFH <sub>d</sub> (IEC 61508:2010)	5.67E-9
SFF	99,8%
Rated voltage	24VDC ± 20%
Dissipated power	3W max
Digital INPUTS (No./description)	8 / PNP active high according to EN 61131-2
INPUT FBK/RESTART (No./description)	2 / EDM control / possible Automatic or Manual operation with RESTART button
Test OUTPUT (No./description)	4 / to check for short-circuits - overloads
SIL 1/PL c OUTPUTS (No./description)	2 / programmable - PNP active high
OSSD (No./description)	2 pairs / solid state safety outputs: PNP active high - 400mA@24VDC max Interface type C class 3 (ZVEI CB24I)
Connection to MOSAIC M1 and MOSAIC M1S, MOSAIC M1S COM	via MSC 5-way ReeR proprietary bus

**MI804 module**

PFH <sub>d</sub> (IEC 61508:2010)	1,32E-8
SFF	99,7%
Rated voltage	24VDC ± 20%
Dissipated power	3W max
Digital INPUTS (No./description)	8 / PNP active high according to EN 61131-2
INPUT FBK/RESTART (No./description)	Up to 4 / EDM control / possible Automatic or Manual operation with RESTART button
Test OUTPUT (No./description)	4 / to check for short-circuits - overloads
SIL 1/PL c OUTPUTS (No./description)	Up to 4 / programmable - PNP active high
OSSD (No./description)	4 single / solid state safety outputs: PNP active high – 400mA@24VDC max Interface type C class 3 (ZVEI CB24I)
Connection to MOSAIC M1S, MOSAIC M1S COM	via MSC 5-way ReeR proprietary bus

**MI8 - MI16 modules**

Model	MI8	MI16
PFH <sub>d</sub> (IEC 61508:2010)	4.46E-9	4.93E-9
SFF	99,7%	99,8%
Rated voltage	24VDC ± 20%	
Dissipated power	3W max	
Digital INPUTS (No./description)	8	16
	PNP active high according to EN 61131-2	
Test OUTPUT (No./description)	4 / to check for short-circuits - overloads	
Connection to MOSAIC M1 and MOSAIC M1S, MOSAIC M1S COM	via MSC 5-way ReeR proprietary bus	

**MI12T8 module**

PFH <sub>d</sub> (IEC 61508:2010)	5,60E-9
SFF	99,7%
Rated voltage	24VDC ± 20%
Dissipated power	3W max
Digital INPUTS (No./description)	12
	PNP active high according to EN 61131-2
Test OUTPUT (No./description)	8 / to check for short-circuits - overloads
Connection to MOSAIC M1 and MOSAIC M1S, MOSAIC M1S COM	via MSC 5-way ReeR proprietary bus

**MO2 - MO4 modules**

Model	MO2	MO4
PFH <sub>d</sub> (IEC 61508:2010)	4,08E-9	5,83E-9
SFF	99,8%	99,8%
Rated voltage	24VDC ± 20%	
Dissipated power	3W max	
INPUT FBK/RESTART (No./description)	2 - 4 / EDM control / possible Automatic or Manual operation with RESTART button	
SIL 1/PL c OUTPUTS (No./description)	2	4
	programmable - PNP active high	
OSSD (No./description)	2	4
	Solid state safety outputs: PNP active high 400mA@24VDC max Interface type C class 3 (ZVEI CB24I)	
Connection to MOSAIC M1 and MOSAIC M1S, MOSAIC M1S COM	via MSC 5-way ReeR proprietary bus	

**MO4L module**

PFH <sub>d</sub> (IEC 61508:2010)	1,11E-8
SFF	99,7%
Rated voltage	24VDC ± 20%
Dissipated power	3W max
INPUT FBK/RESTART (No./description)	Up to 4 / EDM control / possible Automatic or Manual operation with RESTART button
SIL 1/PL c OUTPUTS (No./description)	4 / programmable - PNP active high
OSSD (No./description)	4 single / solid state safety outputs: PNP active high - 400mA@24VDC max - Interface type C class 3 (ZVEI CB24I)
Connection to MOSAIC M1S, MOSAIC M1S COM	via MSC 5-way ReeR proprietary bus

**MOS8 - MOS16 modules**

Model	MOS8	MOS16
PFH <sub>d</sub> (IEC 61508:2010)	4,44E-9	6,61E-9
SFF	99,6%	99,6%
Rated voltage	24VDC ± 20%	
Dissipated power	3W max	
SIL 1/PL c OUTPUTS (No./description)	8	16
	programmable - PNP active high	
Connection to MOSAIC M1 and MOSAIC M1S, MOSAIC M1S COM	through 5-way MSC proprietary bus	

**MR2 - MR4 - MR8 modules**

Model	MR2	MR4	MR8
Rated voltage	24VDC ± 20%		
Dissipated power	3W max		
Switching voltage	240 VAC		
Switching current	6A max		
N.O. contacts	2 N.O. + 1 N.C.	4 N.O. + 2 N.C.	8 N.O. + 4 N.C.
FEEDBACK contacts	1	2	4
Response time	12ms		
Mechanical life of contacts	> 20 x 10 <sup>6</sup>		
Connection to output module	Via front-panel terminal strip (no connection via MSC bus)		

MR2 – MR4 – MR8: TECHNICAL DATA CONCERNING SAFETY											
FEEDBACK CONTACT PRESENT						FEEDBACK CONTACT MISSING					
PFHd	SFF	MTTFd	DCavg	tcycle1		PFHd	SFF	MTTFd	DCavg	tcycle1	
3,09E-10	99,6%	2335,94	98,9%	tcycle1	DC13 (2A)	9,46E-10	60%	2335,93	0	tcycle1	DC13 (2A)
8,53E-11	99,7%	24453,47	97,7%	tcycle2		1,08E-10	87%	24453,47	0	tcycle2	
6,63E-11	99,8%	126678,49	92,5%	tcycle3		6,75E-11	97%	126678,5	0	tcycle3	
8,23E-09	99,5%	70,99	99,0%	tcycle1	AC15 (3A)	4,60E-07	50%	70,99	0	tcycle1	AC15 (3A)
7,42E-10	99,5%	848,16	99,0%	tcycle2		4,49E-09	54%	848,15	0	tcycle2	
1,07E-10	99,7%	12653,85	98,4%	tcycle3		1,61E-10	79%	12653,85	0	tcycle3	
3,32E-09	99,5%	177,38	99,0%	tcycle1	AC15 (1A)	7,75E-08	51%	177,37	0	tcycle1	AC15 (1A)
3,36E-10	99,6%	2105,14	98,9%	tcycle2		1,09E-09	60%	2105,14	0	tcycle2	
8,19E-11	99,7%	28549,13	97,5%	tcycle3		1,00E-10	88%	28549,13	0	tcycle3	

tcycle1: 300s (1 commutation every 5 minutes)

tcycle2: 3600s (1 commutation every hour)

tcycle3: 1 commutation every day

(PFHd according IEC61508, MTTFd and DCavg according ISO13849-1)

**MOR4 – MOR4S8 module**

Model	MOR4	MOR4S8
PFH <sub>d</sub> (IEC 61508:2010)	2,72E-9	1,30E-8
SFF	99,9%	99,7%
Rated voltage	24VDC ± 20%	
Dissipated power max	3W max	
Switching voltage	240 VAC	
Switching current	6A max	
N.O. contacts	4	
INPUT FBK/RESTART (No./description)	4 / EDM control / possible Automatic or Manual operation with RESTART button	
SIL 1/PL c OUTPUTS (No./description)	-	8 / Programmable output PNP active high
Mechanical life of contacts	> 40 x 10 <sup>6</sup>	
MOSAIC M1 connections and MOSAIC M1S, MOSAIC M1S COM	via MSC 5-way Reer proprietary bus	

**MO4LHCS8 module**

PFH <sub>d</sub> (IEC 61508:2010)	8,56E-9
SFF	99,7%
Rated voltage	24VDC ± 20%
Dissipated power max	4W max
OSSD output current	2A max per channel *
Number of Safety Outputs (OSSD)	4 single channels (or 2 dual channels), cat.4 Interface type C class 3 (ZVEI CB24I)
INPUT FBK/RESTART (No./description)	4 / EDM control / possible Automatic or Manual operation with RESTART button
Digital OUTPUT (No./description)	SIL 1/PL c 8 / Programmable output / PNP active high
Response time	12ms
MOSAIC M1 connections and MOSAIC M1S, MOSAIC M1S COM	via MSC 5-way Reer proprietary bus

➔ Using MO4LHCS8 with current output >500mA, separate it from adjacent modules by interposing an MSC connector.

**MV0 - MV1 - MV2 modules**

Condition (-> SPEED CONTROL TYPE FUNCTION BLOCKS)	Overspeed	Stand still	Window speed
Safe state	Overspeed	NO Stand still	Out of Window speed

Model	MV0	MV1	MV2
PFH <sub>d</sub>	7,48E-9	-	-
PFH <sub>d</sub> (TTL)	-	8,58E-9 (MV1T)	9,68E-9 (MV2T)
PFH <sub>d</sub> (sin/cos)	-	9,43E-9 (MV1S)	1,14E-8 (MV2S)
PFH <sub>d</sub> (HTL24)	-	8,20E-9 (MV1H)	8,92E-9 (MV2H)
PFH <sub>d</sub> (TTL internal power supply)	-	9,32E-9 (MV1TB)	1,12E-8 (MV2TB)
SFF (all models)	99,7%		
Rated Voltage	24VDC ± 20%		
Dissipated power max	3W		
Input impedance	-	120 Ohm (MV1T - MV1TB / MV2T - MV2TB models) 120 Ohm (MV1S - MV2S models)	
Encoder Interface	-	TTL (MV1T - MV1TB / MV2T - MV2TB models) HTL (MV1H - MV2H models) sin/cos (MV1S - MV2S models)	
Encoder connections	-	RJ45 connector	
Encoder input signals electrically insulated in accordance with EN 61800-5	-	Rated insulation voltage 250V Overvoltage category II Rated impulse withstand voltage 4.00 kV	
Max number of encoders	-	1	2
Max encoder frequency	-	500kHz (HTL: 300kHz)	
Encoder adjustable threshold range	-	1Hz...450kHz	
Proximity type	PNP/NPN - 3/4 wires		
Proximity connections	Terminal blocks		
Proximity adjustable threshold range	1Hz...4kHz		
Max number of proximity	2		
Max proximity frequency	5kHz		
Max number of axes	2		
Stand-still/overspeed frequency gap	>10Hz		
Min. gap between thresholds (with thresholds >1)	> 5%		



MOSAIC M1 connections and  
MOSAIC M1S, MOSAIC M1S COM

via MSC 5-way ReeR proprietary bus

**MA2, MA4 module**

Module	MA2	MA4
PFH <sub>d</sub> (IEC 61508:2010)	9,54E-9	1,53E-8
SFF	99,5%	99,5%
Rated voltage	24 VDC ± 20%	24 VDC ± 20%
Max dissipated power	3W	5W
Channels number / description	2 / fully isolated (500 VDC) Each channel can be configured as Voltage input or Current input	4 / fully isolated (500 VDC) Each channel can be configured as Voltage input or Current input
Current output sensors		
Range	4...20 mA (0-20 mA)	
Conversion bits	16	
Resolution (minimum current variation releable)	381 Na	
Sample rate (Samples per second)	User selectable. Allowable values: 2.5, 5, 10, 16.6, 20, 50, 60, 100, 200, 400, 800, 1000, 2000, 4000	
Conversion internal resistance	200 Ohm	
Max input current	23 mA	
Voltage output sensors		
Range	0...10 VDC	
Conversion bits	16	
Resolution (minimum voltage variation releable)	152 uV	
Sample rate (Samples per second)	User selectable. Allowable values: 2.5, 5, 10, 16.6, 20, 50, 60, 100, 200, 400, 800, 1000, 2000, 4000	
Conversion internal resistance	250 kOhm	
Diagnostic		
Isolated sensor power supply overload (if the sensor draws more than 30 mA)	YES with active protection. <i>When this condition is detected the power supply of the sensor is disconnected for 1 second and then again activated to check if the overload condition still exist in an endless loop until the overload condition disappear.</i>	
Input overvoltage / input overcurrent	YES with active protection. <i>When this condition is detected the power supply of the sensor is disconnected for 1 second and then again activated to check if the input overvoltage/overcurrent condition still exist in an endless loop until the anomaly disappear.</i>	
Disconnected cable detection	YES	
Overthreshold / Underthreshold detection	YES	
Connection to MOSAIC M1S, MOSAIC M1S COM	via MSC 5-way Reer proprietary bus	

MECHANICAL DIMENSIONS

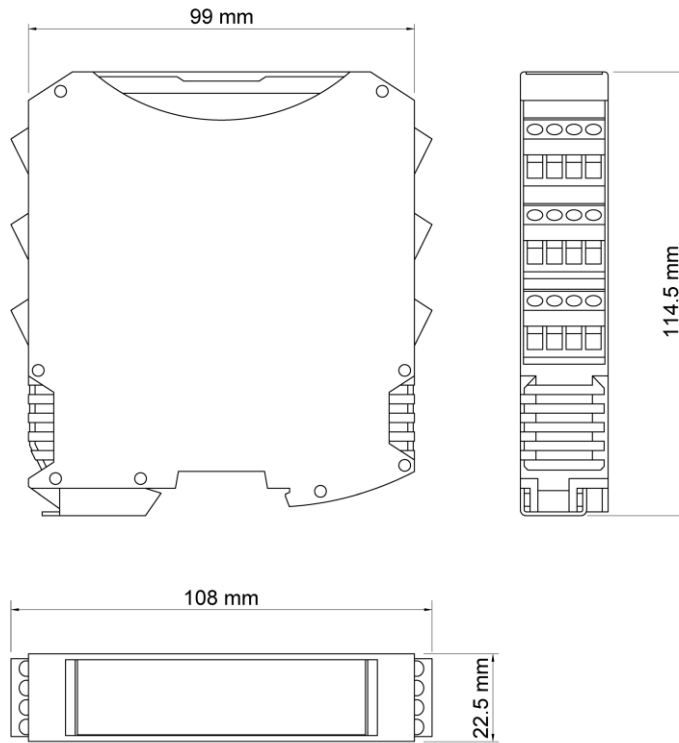

Figure 18 - MOSAIC M1, MOSAIC M1S

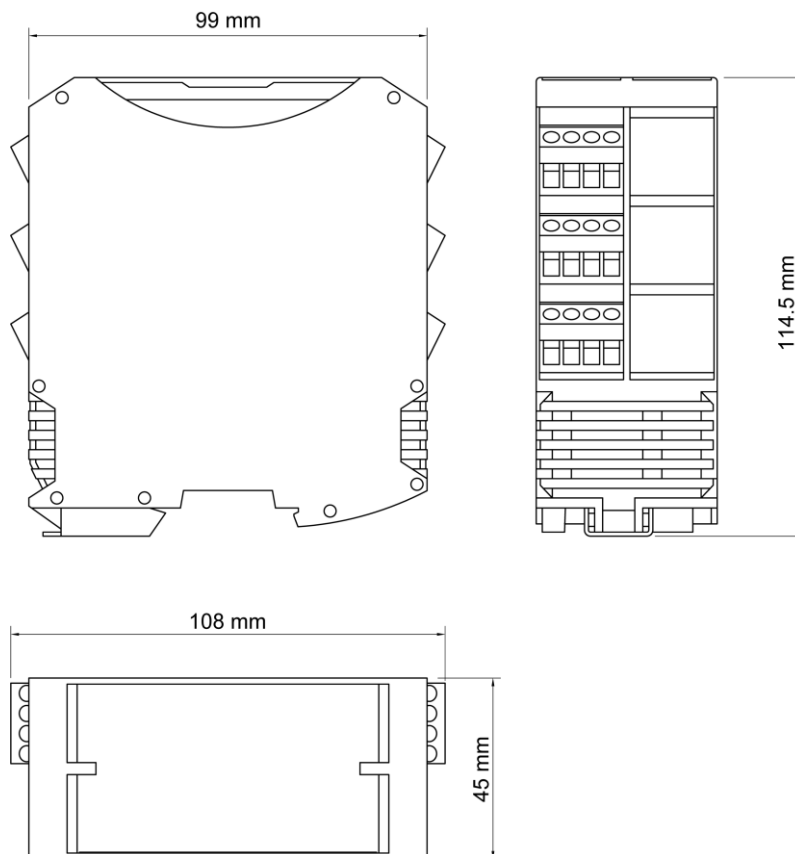
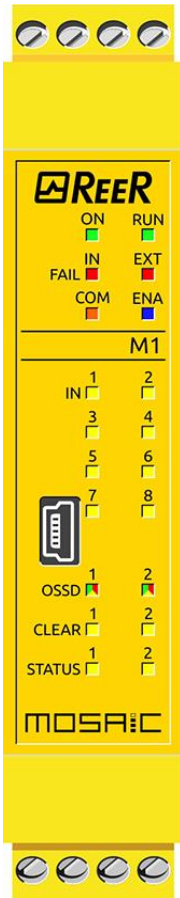

Figure 19 - MOSAIC M1S COM

## LED INDICATORS (Normal Operation)

Master MOSAIC M1 (Figure 20)



MEANING	LED								
	RUN GREEN	IN FAIL RED	EXT FAIL RED	COM ORANGE	ENA BLUE	IN1÷8 YELLOW	OSSD1/2 RED/GREEN	CLEAR1/2 YELLOW	STATUS1/2 YELLOW
Power on - initial TEST	ON	ON	ON	ON	ON	ON	Red	ON	ON
MCM recognised	OFF	OFF	OFF	ON (max 1s)	ON (max 1s)	OFF	Red	OFF	OFF
Writing/loading/ diagram to/from MCM card	OFF	OFF	OFF	5 flashes	5 flashes	OFF	Red	OFF	OFF
MSD requesting connection: internal configuration not present	OFF	OFF	OFF	Flashes slowly	OFF	OFF	Red	OFF	OFF
MSD requesting connection: (slave module or node number not correct) (ref. System composition)	OFF	OFF	OFF	Flashes quickly	OFF	OFF	Red	OFF	OFF
MSD requesting connection: (slave module missing or not ready) (ref. System composition)	Flashes quickly	OFF	OFF	Flashes quickly	OFF	OFF	Red	OFF	OFF
MSD connected MOSAIC M1 stopped	OFF	OFF	OFF	ON	OFF	OFF	Red	OFF	OFF

Table 27 - Opening Screen

MEANING	LED								
	RUN GREEN	IN FAIL RED	EXT FAIL RED	COM ORANGE	IN1÷8 YELLOW	ENA BLUE	OSSD1/2 RED/GREEN	CLEAR1/2 YELLOW	STATUS1/2 YELLOW
NORMAL OPERATION	ON	OFF	OFF op. OK	ON = MOSAIC M1 connected to PC OFF = otherwise	INPUT condition	ON MASTER_ENABLE1 and MASTER_ENABLE2 active OFF otherwise	RED with output OFF	ON waiting for RESTART	OUTPUT condition
EXTERNAL FAULT DETECTED	ON	OFF	ON incorrect external connection detected	ON = MOSAIC M1 connected to PC OFF = otherwise	only the number of the INPUT with the incorrect connection flashes		GREEN with output ON	Flashing NO feedback	

Table 28 - Dynamic Screen

 Figure 20 -  
MOSAIC M1

Master MOSAIC M1S (Figure 20)

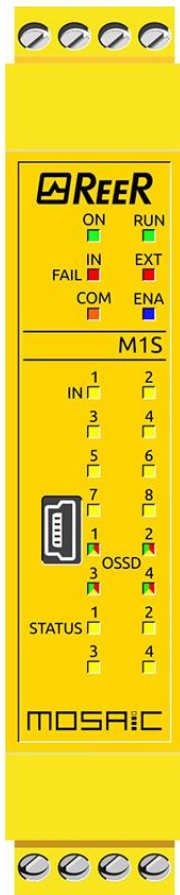

Figure 21 - MOSAIC M1S

MEANING	LED							
	RUN GREEN	IN FAIL RED	EXT FAIL RED	COM ORANGE	ENA BLUE	IN1÷8 YELLOW	OSSD1/4 RED/GREEN/YELLOW	STATUS1/4 YELLOW
Power on - initial TEST	ON	ON	ON	ON	ON	ON	Red	ON
MCM recognised	OFF	OFF	OFF	ON (max 1s)	ON (max 1s)	OFF	Red	OFF
Writing/loading/ diagram to/from MCM card	OFF	OFF	OFF	5 flashes	5 flashes	OFF	Red	OFF
MSD requesting connection: internal configuration not present	OFF	OFF	OFF	Flashes slowly	OFF	OFF	Red	OFF
MSD requesting connection: (slave module or node number not correct) (ref. System composition)	OFF	OFF	OFF	Flashes quickly	OFF	OFF	Red	OFF
MSD requesting connection: (slave module missing or not ready) (ref. System composition)	Flashes quickly	OFF	OFF	Flashes quickly	OFF	OFF	Red	OFF
MSD connected MOSAIC M1 stopped	OFF	OFF	OFF	ON	OFF	OFF	Red	OFF

Table 29 - Opening Screen

MEANING	LED							
	RUN GREEN	IN FAIL RED	EXT FAIL RED	COM ORANGE	IN1÷8 YELLOW	ENA BLUE	OSSD1/4 RED/GREEN/YELLOW	STATUS1/4 YELLOW
NORMAL OPERATION	ON	OFF	OFF op. OK	ON = MOSAIC M1 connected to PC OFF = otherwise	INPUT condition	ON	RED with output OFF GREEN with output ON YELLOW waiting for restart BLINKING YELLOW with inconsistent feedback (if required)	<ul style="list-style-type: none"> <li>Status signal programmed as STATUS: OUTPUT condition</li> <li>Status signal programmed as FBK/RST: INPUT condition</li> </ul>
EXTERNAL FAULT DETECTED	ON	OFF	ON incorrect external connection detected	ON = MOSAIC M1 connected to PC OFF = otherwise	only the number of the INPUT with the incorrect connection flashes			

Table 30 - Dynamic Screen

## Master MOSAIC M1S COM (Figure 20)

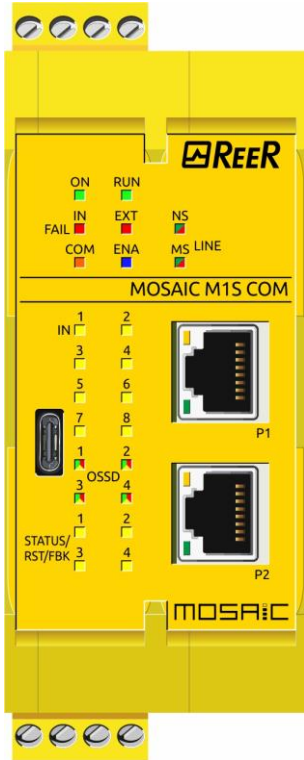
 Figure 22 -  
MOSAIC M1S COM

MEANING	LED							
	RUN GREEN	IN FAIL RED	EXT FAIL RED	COM ORANGE	ENA BLUE	IN1÷8 YELLOW	OSSD1/4 RED/GREEN/YELLOW	STATUS1/4 YELLOW
Power on - initial TEST	ON	ON	ON	ON	ON	ON	Red	ON
MCM recognised	OFF	OFF	OFF	ON (max 1s)	ON (max 1s)	OFF	Red	OFF
Writing/loading/ diagram to/from MCM card	OFF	OFF	OFF	5 flashes	5 flashes	OFF	Red	OFF
MSD requesting connection: internal configuration not present	OFF	OFF	OFF	Flashes slowly	OFF	OFF	Red	OFF
MSD requesting connection: (slave module or node number not correct) (ref. System composition)	OFF	OFF	OFF	Flashes quickly	OFF	OFF	Red	OFF
MSD requesting connection: (slave module missing or not ready) (ref. System composition)	Flashes quickly	OFF	OFF	Flashes quickly	OFF	OFF	Red	OFF
MSD connected MOSAIC M1S COM stopped	OFF	OFF	OFF	ON	OFF	OFF	Red	OFF
MOSAIC M1S COM new Fieldbus loading	OFF	OFF	OFF	Flashes quickly and alternatively		OFF	Red	OFF

Table 31 - Opening Screen

MEANING	LED							
	RUN GREEN	IN FAIL RED	EXT FAIL RED	COM ORANGE	IN1÷8 YELLOW	ENA BLUE	OSSD1/4 RED/GREEN/YELLOW	STATUS1/4 YELLOW
NORMAL OPERATION	ON	OFF	OFF op. OK	ON = MOSAIC M1S COM connected to PC OFF=otherwise	INPUT condition	ON	RED with output OFF GREEN with output ON YELLOW waiting for restart	<ul style="list-style-type: none"> <li>Status signal programmed as STATUS: OUTPUT condition</li> <li>Status signal programmed as FBK/RST: INPUT condition</li> </ul>
EXTERNAL FAULT DETECTED	ON	OFF	ON incorrect external connection detected	ON = MOSAIC M1S COM connected to PC OFF=otherwise	only the number of the INPUT with the incorrect connection flashes		BLINKING YELLOW with inconsistent feedback (if required)	

Table 32 - Dynamic Screen

MOSAIC M1S COM specific Fieldbus LED indicators

EtherCAT LEDs

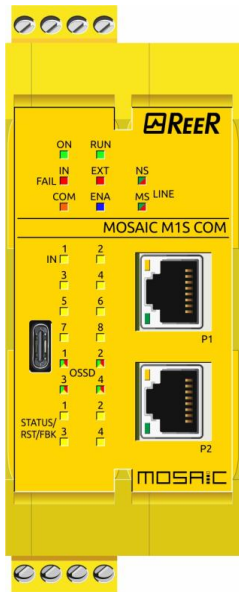

LED	COLOR	STATE	MEANING
<b>MS (Red/Green)</b> RUN STATUS	OFF ○	OFF	<b>INIT:</b> The device is in INIT state
	GREEN ✱	Blinking (2.5 Hz)	<b>PRE-OPERATIONAL:</b> The device is in PRE-OPERATIONAL state
	GREEN ✱	Single flash	<b>SAFE-OPERATIONAL:</b> The device is in SAFE-OPERATIONAL state
	GREEN ●	ON	<b>OPERATIONAL:</b> The device is in OPERATIONAL state
<b>NS (Red/Green)</b> ERROR STATUS	OFF ○	OFF	<b>NO ERROR:</b> The EtherCAT communication of the device is in working condition
	RED ✱	Blinking (2.5 Hz)	<b>INVALID CONFIGURATION:</b> General Configuration Error. Possible reason: State change commanded by master is impossible due to register or object settings.
	RED ✱	Single flash	<b>LOCAL ERROR:</b> Slave device application has changed the EtherCAT state autonomously. Possible reason 1: A host watchdog timeout has occurred. Possible reason 2: Synchronization Error, device enters Safe-Operational automatically.
	RED ✱	Double flash	<b>APPLICATION WATCHDOG TIMEOUT:</b> An application watchdog timeout has occurred. Possible reason: Sync Manager Watchdog timeout.

LED state explanation

STATE	MEANING
<b>Blinking (2.5 Hz)</b>	The indicator turns on and off with a frequency of 2.5 Hz: "on" for 200 ms, followed by "OFF" for 200 ms.
<b>Single flash</b>	The indicator shows one short flash (200 ms) followed by a long "OFF" phase (1,000 ms).
<b>Double flash</b>	The indicator shows a sequence of two short flashes (each 200 ms), separated by a short "OFF" phase (200 ms). The sequence is finished by a long "OFF" phase (1,000 ms).

## EtherNET/IP LEDs

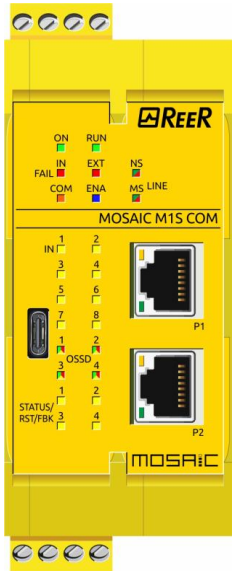

LED	COLOR	STATE	MEANING
MS (Red/Green) MODULE STATUS	GREEN ●	ON	<b>DEVICE OPERATIONAL:</b> The device is operating correctly
	GREEN ✱	Flashing (1 Hz)	<b>STANDBY:</b> The device has not been configured.
	GREEN ✱ / RED ✱ / GREEN ✱	Flashing Green/Red/Green	<b>SELF-TEST:</b> The device is performing its power-up testing. The module status indicator test sequence occurs before the network status indicator test sequence, according to the following sequence: <ul style="list-style-type: none"> <li>• Network status LED off.</li> <li>• Module status LED turns green for approximately 250 ms, turns red for approximately 250 ms, and again turns green (and holds that state until the power-up test has completed).</li> <li>• Network status LED turns green for approximately 250 ms, turns red for approximately 250 ms, and then turns off (and holds that state until the power-up test has completed).</li> </ul>
	RED ✱	Flashing (1 Hz)	<b>MAJOR RECOVERABLE FAULT:</b> The device has detected a major recoverable fault. e.g., an incorrect or inconsistent configuration can be considered a major recoverable fault.
	RED ●	ON	<b>MAJOR UNRECOVERABLE FAULT:</b> The device has detected a major unrecoverable fault.
	OFF ○	OFF	<b>NO POWER:</b> The device is powered off.
	NS (Red/Green) NODE STATUS	GREEN ●	ON
GREEN ✱		Flashing (1 Hz)	<b>NO CONNECTIONS:</b> An IP address is configured, but no CIP connections are established, and an Exclusive Owner connection has not timed out.
GREEN ✱ / RED ✱ / OFF ○		Flashing Green/Red/OFF	<b>SELF-TEST:</b> The device is performing its power-up testing.
RED ✱		Flashing (1 Hz)	<b>CONNECTION TIMEOUT:</b> An IP address is configured, and an Exclusive Owner connection for which this device is the target has timed out. The network status indicator returns to steady green only when all timed out Exclusive Owner connections are reestablished.
RED ●		ON	<b>DUPLICATE IP:</b> The device has detected that its IP address is already in use.
OFF ○		OFF	<b>NO POWER:</b> The device does not have an IP address (or is powered off).



LED state explanation

STATE	MEANING
<b>Flashing (1 Hz)</b>	The indicator turns on and off with a frequency of 1 Hz: "ON" for 500 ms, followed by "OFF" for 500 ms.
<b>Flashing green/red/green</b>	The MS LED indicator turns on green on for 250 ms, then red on for 250 ms, then green on (until the test is completed).
<b>Flashing green/red/OFF</b>	The NS LED indicator turns on green on for 250 ms, then red on for 250 ms, then off (until the test is completed).

Modbus/TCP LEDs

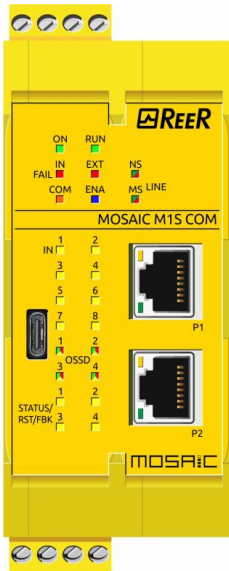

LED	COLOR	STATE	MEANING
<b>MS (Red/Green) MODULE STATUS</b>	<b>GREEN ●</b>	ON	<b>CONNECTED:</b> OMB task has communication. At least one TCP connection is established.
	<b>GREEN ✱</b>	Flashing (1 Hz)	<b>READY, NOT CONFIGURED YET:</b> OMB task is ready and not yet configured.
	<b>GREEN ✱</b>	Flashing (5 Hz)	<b>WAITING FOR COMMUNICATION:</b> OMB task is configured.
	<b>OFF ○</b>	OFF	<b>NOT READY:</b> OMB task is not ready.
<b>NS (Red/Green) ERROR STATUS</b>	<b>OFF ○</b>	OFF	<b>NO ERROR:</b> No communication error
	<b>RED ✱</b>	Flashing (2 Hz, 25% on)	<b>SYSTEM ERROR:</b> System error
	<b>RED ●</b>	ON	<b>COMMUNICATION ERROR:</b> Communication error active

LED state explanation

STATE	MEANING
<b>Flashing (1 Hz)</b>	The indicator turns on and off with a frequency of 1 Hz: "on" for 500 ms, followed by "off" for 500 ms.
<b>Flashing (2 Hz, 25% on)</b>	The indicator turns on and off with a frequency of 2 Hz: "on" for 125 ms, followed by "off" for 375 ms.
<b>Flashing (5 Hz)</b>	The indicator turns on and off with a frequency of 5 Hz: "on" for 100 ms, followed by "off" for 100 ms.

## PROFINET LEDs

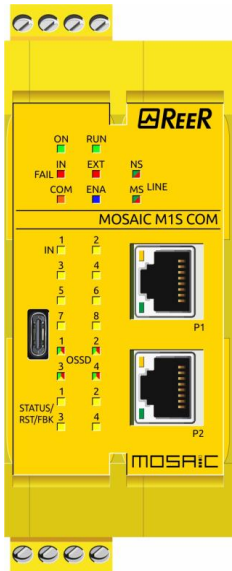

LED	COLOR	STATE	MEANING
MS (Red/Green) SYSTEM FAILURE	OFF ○	OFF	NO ERROR
	RED ✱	Flashing (1 Hz, 3 s)	DCP signal service is initiated via the bus
	RED ●	ON	WATCHDOG TIMEOUT: channel, generic or extended diagnosis present; system error
NS (Red/Green) BUS FAILURE	OFF ○	OFF	NO ERROR
	RED ✱	Flashing (2 Hz)	NO DATA EXCHANGE
	RED ●	ON	NO CONFIGURATION: or low speed physical link; or no physical link

## LED state explanation

STATE	MEANING
Flashing (1 Hz, 3 s)	The indicator turns on and off for 3 seconds with a frequency of 1 Hz: "on" for 500 ms, followed by "off" for 500 ms.
Flashing (2 Hz)	The indicator turns on and off with a frequency of 2 Hz: "on" for 250 ms, followed by "off" for 250 ms.

MI802 (Figure 23)

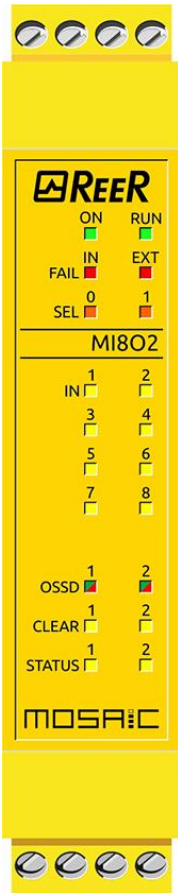

Figure 23 - MI802

MEANING	LED							
	RUN GREEN	IN FAIL RED	EXT FAIL RED	SELO/1 ORANGE	IN1 ÷ 8 YELLOW	OSSD1/2 RED/GREEN	CLEAR1/2 YELLOW	STATUS1/2 YELLOW
Power on - initial TEST	ON	ON	ON	ON	ON	Red	ON	ON

Table 33 - Opening Screen

MEANING	LED							
	RUN GREEN	IN FAIL RED	EXT FAIL RED	IN1 ÷ 8 YELLOW	SELO/1 ORANGE	OSSD1/2 RED/GREEN	CLEAR1/2 YELLOW	STATUS1/2 YELLOW
NORMAL OPERATION	OFF if the unit is waiting for the first communication from the MASTER	OFF	OFF	INPUT condition	Shows the NODE_SELO/1 signal table	RED with output OFF GREEN with output ON	ON waiting for RESTART	OUTPUT condition
	FLASHES if no INPUT or OUTPUT requested by the configuration		ON incorrect external connection detected	only the number of the INPUT with the incorrect connection flashes				
	ON if INPUT or OUTPUT requested by the configuration							

Table 34 - Dynamic Screen

MI804 (Figure 23)

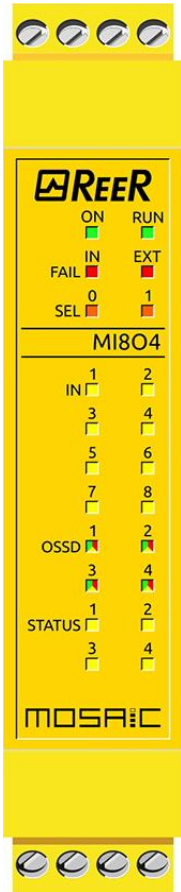

MEANING	LED						
	RUN GREEN	IN FAIL RED	EXT FAIL RED	SELO/1 ORANGE	IN1÷8 YELLOW	OSSD1/4 RED/GREEN/YELLOW	STATUS1/4 YELLOW
Power on - initial TEST	ON	ON	ON	ON	ON	Red	ON

Table 35 - Opening Screen

MEANING	LED						
	RUN GREEN	IN FAIL RED	EXT FAIL RED	IN1÷8 YELLOW	SELO/1 ORANGE	OSSD1/4 RED/GREEN/YELLOW	STATUS1/4 YELLOW
NORMAL OPERATION	<p>OFF if the unit is waiting for the first communication from the MASTER</p> <p>FLASHES if no INPUT or OUTPUT requested by the configuration</p> <p>ON if INPUT or OUTPUT requested by the configuration</p>	OFF	OFF	INPUT condition	Shows the NODE_SELO/1 signal table	<p>RED with output OFF</p> <p>GREEN with output ON</p> <p>YELLOW waiting for restart</p> <p>BLINKING YELLOW with inconsistent feedback (if required)</p>	<ul style="list-style-type: none"> <li>Status signal programmed as STATUS: OUTPUT condition</li> <li>Status signal programmed as FBK/RST: INPUT condition</li> </ul>

Table 36 - Dynamic Screen

Figure 24 - MI804

MI8 (Figure 25)

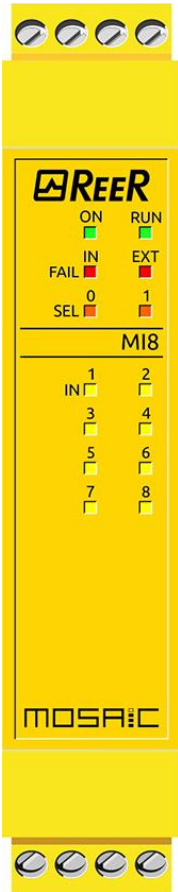

Figure 25 - MI8

MEANING	LED				
	RUN GREEN	IN FAIL RED	EXT FAIL RED	SELO/1 ORANGE	IN1÷8 YELLOW
Power on - initial TEST	ON	ON	ON	ON	ON

Table 37 - Opening Screen

MEANING	LED				
	RUN GREEN	IN FAIL RED	EXT FAIL RED	SELO/1 ORANGE	IN1÷8 YELLOW
NORMAL OPERATION	OFF if the unit is waiting for the first communication from the MASTER FLASHES if no INPUT or OUTPUT requested by the configuration	OFF	OFF	Shows the NODE_SELO/1 signal table	INPUT condition
	ON if INPUT or OUTPUT requested by the configuration		ON incorrect external connection detected		only the number of the INPUT with the incorrect connection flashes

Table 38 - Dynamic Screen

MI12T8 (Figure 27)

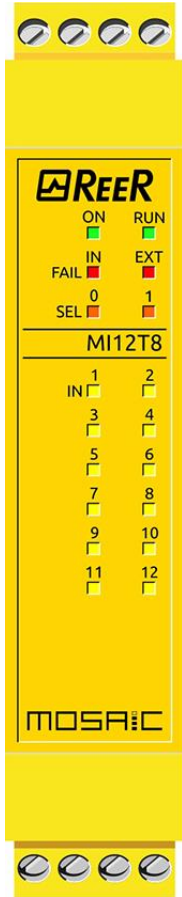

MEANING	LED				
	RUN GREEN	IN FAIL RED	EXT FAIL RED	SELO/1 ORANGE	IN1 ÷ 12 YELLOW
Power on - initial TEST	ON	ON	ON	ON	ON

Table 39 - Opening Screen

MEANING	LED				
	RUN GREEN	IN FAIL RED	EXT FAIL RED	SELO/1 ORANGE	IN1 ÷ 12 YELLOW
NORMAL OPERATION	OFF if the unit is waiting for the first communication from the MASTER FLASHES if no INPUT or OUTPUT requested by the configuration	OFF	OFF	Shows the NODE_SELO/1 signal table	INPUT condition
	ON if INPUT or OUTPUT requested by the configuration		ON incorrect external connection detected		only the number of the INPUT with the incorrect connection flashes

Table 40 - Dynamic Screen

Figure 26-MI12T8

MI16 (Figure 27)

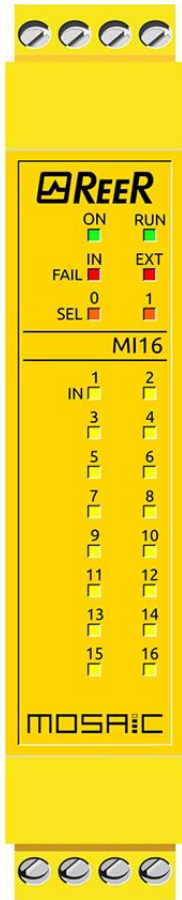

Figure 27 - MI16

MEANING	LED				
	RUN GREEN	IN FAIL RED	EXT FAIL RED	SELO/1 ORANGE	IN1 ÷ 16 YELLOW
Power on - initial TEST	ON	ON	ON	ON	ON

Table 41 - Opening Screen

MEANING	LED				
	RUN GREEN	IN FAIL RED	EXT FAIL RED	SELO/1 ORANGE	IN1 ÷ 16 YELLOW
NORMAL OPERATION	OFF if the unit is waiting for the first communication from the MASTER FLASHES if no INPUT or OUTPUT requested by the configuration	OFF	OFF	Shows the NODE_SELO/1 signal table	INPUT condition
	ON if INPUT or OUTPUT requested by the configuration		ON incorrect external connection detected		only the number of the INPUT with the incorrect connection flashes

Table 42 - Dynamic Screen

MO2 (Figure 28)

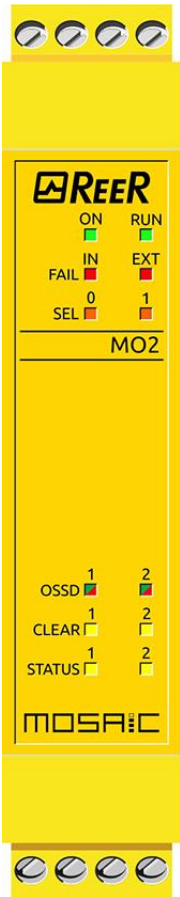

Figure 28 - MO2

MEANING	LED						
	RUN GREEN	IN FAIL RED	EXT FAIL RED	SELO/1 ORANGE	OSDD1/2 RED/GREEN	CLEAR1/2 YELLOW	STATUS1/2 YELLOW
Power on - initial TEST	ON	ON	ON	ON	Red	ON	ON

Table 43 - Opening screen

MEANING	LED						
	RUN GREEN	IN FAIL RED	EXT FAIL RED	SELO/1 ORANGE	OSDD1/2 RED/GREEN	CLEAR1/2 YELLOW	STATUS1/2 YELLOW
NORMAL OPERATION	OFF if the unit is waiting for the first communication from the MASTER FLASHES if no INPUT or OUTPUT requested by the configuration ON if INPUT or OUTPUT requested by the configuration	OFF op. OK	OFF op. OK	Shows the NODE_SELO/1 signal table	RED with output OFF GREEN with output ON	ON waiting for RESTART Flashes NO feedback	OUTPUT condition

Table 44 - Dynamic screen



MO4 (Figure 29)

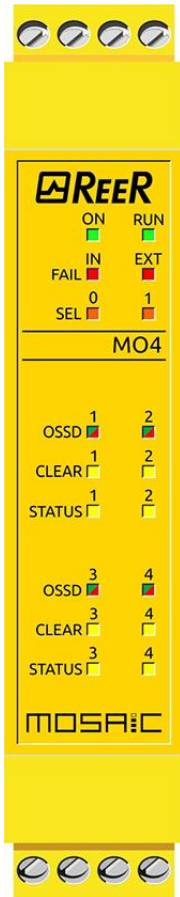

Figure 29 - MO4

MEANING	LED						
	RUN GREEN	IN FAIL RED	EXT FAIL RED	SELO/1 ORANGE	OSSD1/4 RED/GREEN	CLEAR1/4 YELLOW	STATUS1/4 YELLOW
Power on - initial TEST	ON	ON	ON	ON	Red	ON	ON

Table 45 - Opening screen

MEANING	LED						
	RUN GREEN	IN FAIL RED	EXT FAIL RED	SELO/1 ORANGE	OSSD1/4 RED/GREEN	CLEAR1/4 YELLOW	STATUS1/4 YELLOW
NORMAL OPERATION	OFF if the unit is waiting for the first communication from the MASTER FLASHES if no INPUT or OUTPUT requested by the configuration ON if INPUT or OUTPUT requested by the configuration	OFF op. OK	OFF op. OK	Shows the NODE_SELO/1 signal table	RED with output OFF  GREEN with output ON	ON waiting for RESTART  Flashes NO feedback	OUTPUT condition

Table 46 - Dynamic Screen

MO4L (Figure 23)

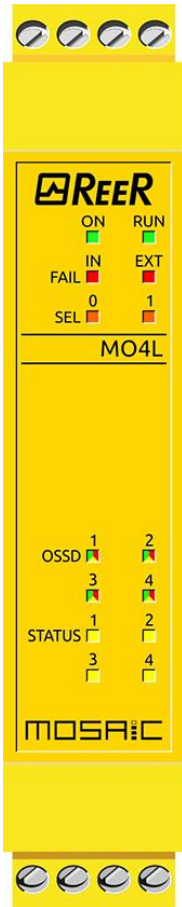

Figure 30 - MO4L

MEANING	LED					
	RUN GREEN	IN FAIL RED	EXT FAIL RED	SELO/1 ORANGE	OSSD1/4 RED/GREEN/YELLOW	STATUS1/4 YELLOW
Power on - initial TEST	ON	ON	ON	ON	Red	ON

Table 47 - Opening Screen

MEANING	LED					
	RUN GREEN	IN FAIL RED	EXT FAIL RED	SELO/1 ORANGE	OSSD1/4 RED/GREEN/YELLOW	STATUS1/4 YELLOW
NORMAL OPERATION	OFF if the unit is waiting for the first communication from the MASTER  FLASHES if no INPUT or OUTPUT requested by the configuration  ON if INPUT or OUTPUT requested by the configuration	OFF	OFF  ON incorrect external connection detected	Shows the NODE_SELO/1 signal table	RED with output OFF GREEN with output ON YELLOW waiting for restart BLINKING YELLOW with inconsistent feedback (if required)	<ul style="list-style-type: none"> <li>Status signal programmed as STATUS: OUTPUT condition</li> <li>Status signal programmed as FBK/RST: INPUT condition</li> </ul>

Table 48 - Dynamic screen

MOR4 (Figure 31)

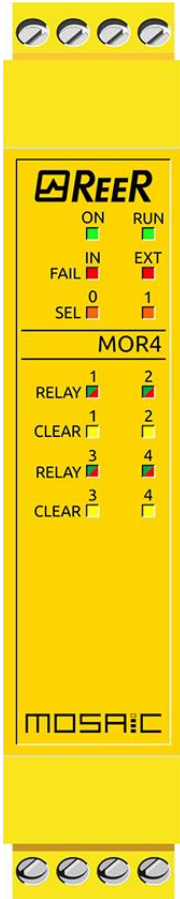

Figure 31 - MOR4

MEANING	LED						
	RUN	IN FAIL	EXT FAIL	SELO/1	RELAY 1/4		CLEAR1/4
	GREEN	RED	RED	ORANGE	RED	GREEN	YELLOW
Power on - initial TEST	ON	ON	ON	ON	Red		ON

Table 49 - Opening screen

MEANING	LED						
	RUN	IN FAIL	EXT FAIL	SELO/1	RELAY 1/4		CLEAR1/4
	GREEN	RED	RED	ORANGE	RED	GREEN	YELLOW
NORMAL OPERATION	OFF if the unit is waiting for the first communication from the MASTER	OFF operation OK	OFF operation OK	Shows the NODE_SELO/1 signal table	RED with contact opened		ON waiting for RESTART
	FLASHES if no INPUT or OUTPUT requested by the configuration				GREEN with contact closed		FLASHES External contactors feedback error
	ON if INPUT or OUTPUT requested by the configuration						

Table 50 - Dynamic screen

MOR4S8 (Figure 32)

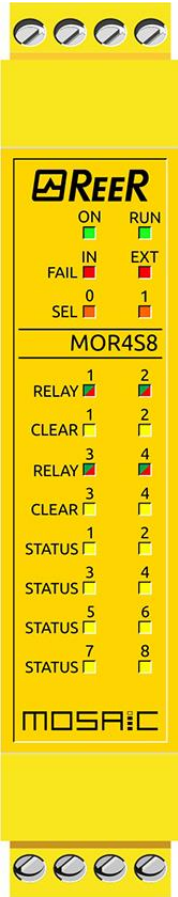

Figure 32 - MOR4S8

MEANING	LED							
	RUN	IN FAIL	EXT FAIL	SELO/1	RELAY 1/4		CLEAR1/4	STATUS1/8
	GREEN	RED	RED	ORANGE	RED	GREEN	YELLOW	YELLOW
Power on - initial TEST	ON	ON	ON	ON	Red		ON	ON

Table 51 - Opening screen

MEANING	LED							
	RUN	IN FAIL	EXT FAIL	SELO/1	RELAY 1/4		CLEAR1/4	STATUS1/8
	GREEN	RED	RED	ORANGE	RED	GREEN	YELLOW	YELLOW
NORMAL OPERATION	OFF if the unit is waiting for the first communication from the MASTER	OFF operation OK	OFF operation OK	Shows the NODE_SELO/1 signal table	RED with contact opened		ON waiting for RESTART	OUTPUT condition
	FLASHES if no INPUT or OUTPUT requested by the configuration				GREEN with contact closed		FLASHES wrong feedback external contactors	
	ON if INPUT or OUTPUT requested by the configuration							

Table 52 - Dynamic screen

MOS8 (Figure 33)

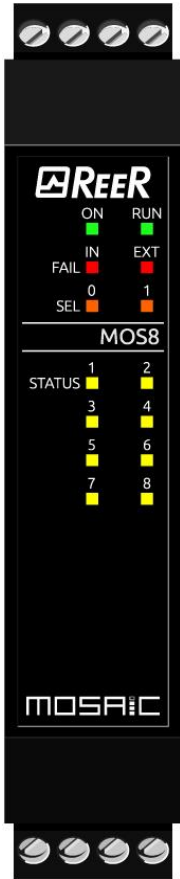

Figure 33 - MOS8

LED					
MEANING	RUN	IN FAIL	EXT FAIL	SELO/1	STATUS1/8
	GREEN	RED	RED	ORANGE	YELLOW
Power on - initial TEST	ON	ON	ON	ON	ON

Table 53 - Opening screen

LED					
MEANING	RUN	IN FAIL	EXT FAIL	SELO/1	STATUS1/8
	GREEN	RED	RED	ORANGE	YELLOW
NORMAL OPERATION	OFF if the unit is waiting for the first communication from the MASTER  FLASHES if no INPUT or OUTPUT requested by the configuration  ON if INPUT or OUTPUT requested by the configuration	OFF operation OK	OFF operation OK	Shows the NODE_SELO/1 signal table	OUTPUT condition

Table 54 - Dynamic screen

MOS16 (Figure 34)

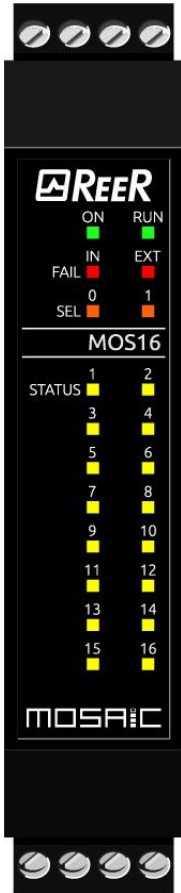

LED					
MEANING	RUN	IN FAIL	EXT FAIL	SELO/1	STATUS1/16
	GREEN	RED	RED	ORANGE	YELLOW
Power on - initial TEST	ON	ON	ON	ON	ON

Table 55 - Opening screen

LED					
MEANING	RUN	IN FAIL	EXT FAIL	SEL 0/1	STATUS1/16
	GREEN	RED	RED	ORANGE	YELLOW
NORMAL OPERATION	<p>OFF if the unit is waiting for the first communication from the MASTER</p> <p>FLASHES if no INPUT or OUTPUT requested by the configuration</p> <p>ON if INPUT or OUTPUT requested by the configuration</p>	OFF operation OK	OFF operation OK	Shows the NODE_SELO/1 signal table	OUTPUT condition

Table 56 - Dynamic screen

Figure 34 - MOS16

English

MV0, MV1, MV2 (Figure 35)

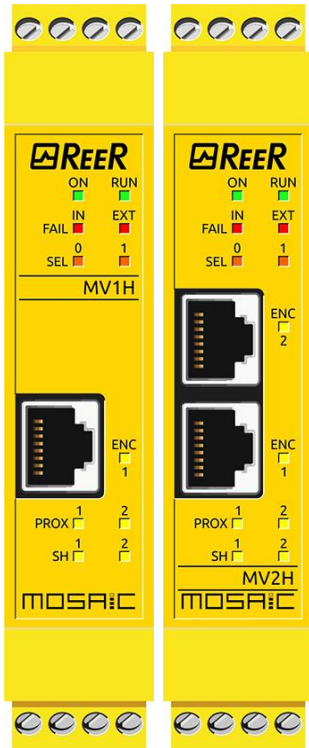

Figure 35 - MV1, MV2

MEANING	LED						
	RUN	IN FAIL	EXT FAIL	SELO/1	ENC*	PROX	SH
	GREEN	RED	RED	ORANGE	YELLOW	YELLOW	YELLOW
Power on - initial TEST	ON	ON	ON	ON	ON	ON	ON

Table 57 - Opening screen

MEANING	LED						
	RUN	IN FAIL	EXT FAIL	SELO/1	ENC*	PROX	SH
	GREEN	RED	RED	ORANGE	YELLOW	YELLOW	YELLOW
NORMAL OPERATION	OFF if the unit is waiting for the first communication from the MASTER	OFF operation OK	OFF operation OK	Shows the NODE_SELO/1 signal table	ON Encoder connected and operative	ON Proximity connected and operative	OFF Axis in normal speed range
	FLASHES if no INPUT or OUTPUT requested by the configuration						ON Axis in stand still
	ON if INPUT or OUTPUT requested by the configuration						BLINKING Axis in overspeed

Table 58 - Dynamic screen

\* NOT PRESENT ON MVO MODULE

MR2, MR4, MR8 (Figure 36)



Figure 36 - MR2, MR4, MR8

MEANING	LED	
	OSSD1 GREEN	
NORMAL OPERATION	ON with output activated	

Table 59 - MR2 - Dynamic screen

MEANING	LED	
	OSSD1 GREEN	OSSD2 GREEN
NORMAL OPERATION	ON with output activated	

Table 60 - MR4 - Dynamic screen

MEANING	LED			
	OSSD1 GREEN	OSSD2 GREEN	OSSD3 GREEN	OSSD4 GREEN
NORMAL OPERATION	ON with output activated			

Table 61 - MR8 - Dynamic screen



MO4LHCS8 (Figure 37)

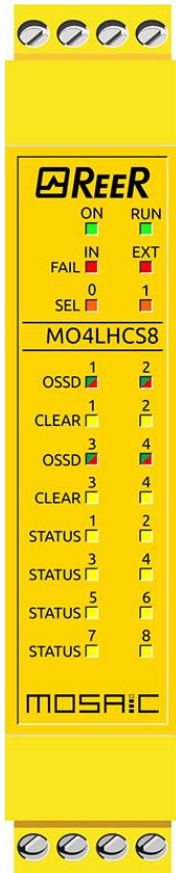

Figure 37 - MO4LHCS8

MEANING	LED							
	RUN	IN FAIL	EXT FAIL	SELO/1	OSSD 1/4		CLEAR1/4	STATUS1/8
	GREEN	RED	RED	ORANGE	RED	GREEN	YELLOW	YELLOW
Power on - initial TEST	ON	ON	ON	ON	Red		ON	ON

Table 62 - Opening screen

MEANING	LED							
	RUN	IN FAIL	EXT FAIL	SELO/1	OSSD 1/4		CLEAR1/4	STATUS1/8
	GREEN	RED	RED	ORANGE	RED	GREEN	YELLOW	YELLOW
NORMAL OPERATION	OFF if the unit is waiting for the first communication from the MASTER	OFF operation OK	OFF operation OK	Shows the NODE_SELO/1 signal table	RED with output OFF		ON waiting for RESTART	ON The associated output is active
	FLASHES if no INPUT or OUTPUT requested by the configuration				GREEN with output ON		FLASHES wrong feedback external contactors	OFF The associated output is NOT active
	ON if INPUT or OUTPUT requested by the configuration							

Table 63 - Dynamic screen

MA2, MA4 (Figure 38)

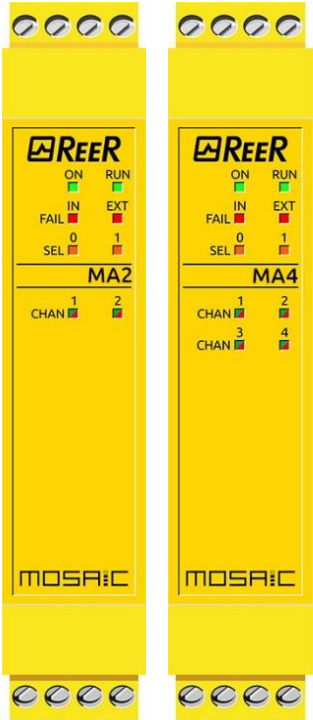

Figure 38 – MA2, MA4

MEANING	LED				
	RUN GREEN	IN FAIL RED	EXT FAIL RED	SELO/1 ORANGE	CHAN 1/4 RED/GREEN
Power on - initial TEST	ON	ON	ON	ON	RED ON

Table 64 – Initial operation LEDs state

MEANING	LED					
	RUN	IN FAIL	EXT FAIL	SELO/1	CHAN 1/4	
	GREEN	RED	RED	ORANGE	RED	GRN
NORMAL OPERATION	OFF if the unit is waiting for the first communication from the MASTER				Channel configured	
	FLASHES if no INPUT configuration is requested from MASTER		OFF Normal operation	Shows the NODE_SELO/1 signal table	OFF	ON
	ON if INPUT configuration is requested from MASTER	OFF	ON Anomaly detected on measurement channel		Channel NOT configured	
					OFF	OFF

Table 65 - Dynamic operation LEDs state

LED INDICATORS (Troubleshooting)

Master MOSAIC M1 (Figure 39)

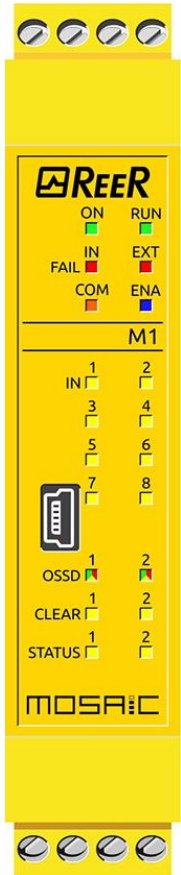

MEANING	LED									REMEDY
	RUN GREEN	IN FAIL RED	EXT FAIL RED	COM ORANGE	IN1÷8 YELLOW	ENA BLUE	OSSD1/2 RED/GREEN	CLEAR1/2 YELLOW	STATUS1/2 YELLOW	
Internal fat	OFF	2 or 3 flashes	OFF	OFF	OFF	OFF	Red	OFF	OFF	Return the unit to ReeR to be repaired
OSSD output error	OFF	4 flashes	OFF	OFF	OFF	OFF	4 flashes (only the LED corresponding to the output in FAIL mode)	OFF	OFF	<ul style="list-style-type: none"> <li>Check the OSSD1/2 connections</li> <li>If the problem persists return the MOSAIC M1 to ReeR to be repaired</li> </ul>
Error in communication with slave	OFF	5 flashes	OFF	OFF	OFF	OFF	OFF	OFF	OFF	<ul style="list-style-type: none"> <li>Restart the system.</li> <li>If the problem persists return the MOSAIC M1 to ReeR to be repaired</li> </ul>
Slave unit error	OFF	ON	OFF	OFF	OFF	OFF	OFF	OFF	OFF	<ul style="list-style-type: none"> <li>Restart the system</li> <li>Check which unit is in FAIL mode</li> </ul>
MCM error	OFF	6 flashes	OFF	6 flashes	OFF	OFF	OFF	OFF	OFF	Replace the MCM

Table 66 - Troubleshooting MOSAIC M1

Figure 39 - MOSAIC M1

Master MOSAIC M1S / MOSAIC M1S COM (Figure 40)

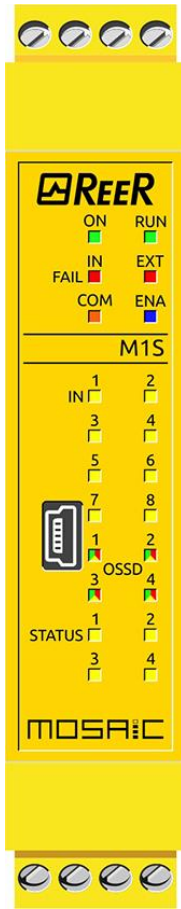

MEANING	LED								REMEDY
	RUN GREEN	IN FAIL RED	EXT FAIL RED	COM ORANGE	IN1÷8 YELLOW	ENA BLUE	OSSD1/4 RED/GREEN/YELLOW	STATUS1/4 YELLOW	
Internal fault	OFF	2 or 3 flashes	OFF	OFF	OFF	OFF	Red	OFF	Return the unit to Reer to be repaired
OSSD output error	OFF	4 flashes	OFF	OFF	OFF	OFF	4 flashes (only the LED corresponding to the output in FAIL mode)	OFF	<ul style="list-style-type: none"> <li>Check the OSSD1/2 connections</li> <li>If the problem persists return the MOSAIC M1 to Reer to be repaired</li> </ul>
Error in communication with slave	OFF	5 flashes	OFF	OFF	OFF	OFF	OFF	OFF	<ul style="list-style-type: none"> <li>Restart the system.</li> <li>If the problem persists return the MOSAIC M1 to Reer to be repaired</li> </ul>
Slave unit error	OFF	ON	OFF	OFF	OFF	OFF	OFF	OFF	<ul style="list-style-type: none"> <li>Restart the system</li> <li>Check which unit is in FAIL mode</li> </ul>
MCM error	OFF	6 flashes	OFF	6 flashes	OFF	OFF	OFF	OFF	Replace the MCM
Overload on OSSD / OSSD load connected to 24V	ON	OFF	ON	OFF	Inputs State	ON	Red blinking (only LED corresponding to the relative output)	OUTPUT state	<ul style="list-style-type: none"> <li>Verify OSSD connections</li> </ul>
Short circuit or overload detected on status output	ON	OFF	ON	OFF	Inputs State	ON	OUTPUT state	blinking	<ul style="list-style-type: none"> <li>Verify output status connections</li> </ul>

Figure 40 - MOSAIC M1S status output

Table 67 - Troubleshooting MOSAIC M1S

MI802 (Figure 41)

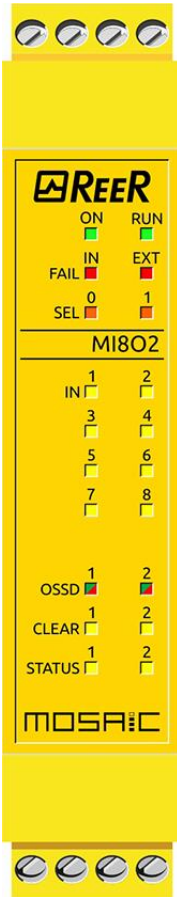

MEANING	LED								REMEDY	
	RUN	IN FAIL	EXT FAIL	SELO/1	IN1 ÷ 8	OSSD1/2	CLEAR1/2	STATUS1/2		
	GREEN	RED	RED	ORANGE	YELLOW	RED/GREEN	YELLOW	YELLOW		
Internal fault	OFF	2 or 3 flashes	OFF	Shows the physical address of the unit	OFF	Red	OFF	OFF	<ul style="list-style-type: none"> <li>Return the unit to ReeR to be repaired</li> </ul>	
Compatibility error	OFF	5 flashes	OFF		5 flashes	5 flashes	5 flashes	5 flashes	<ul style="list-style-type: none"> <li>Firmware version not compatible with MOSAIC M1, return to ReeR for FW upgrade.</li> </ul>	
OSSD output error	OFF	4 flashes	OFF		OFF	4 flashes (only the LED corresponding to the output in FAIL mode)	OFF	OFF	<ul style="list-style-type: none"> <li>Check OSSD1/2 connections</li> <li>If the problem persists, return the unit to ReeR to be repaired</li> </ul>	
Error in communication with master	OFF	5 flashes	OFF		OFF	OFF	OFF	OFF	<ul style="list-style-type: none"> <li>Restart the system</li> <li>If the problem persists, return the MI802 to ReeR to be repaired</li> </ul>	
Error on other slave or MOSAIC M1	OFF	ON	OFF		OFF	OFF	OFF	OFF	<ul style="list-style-type: none"> <li>Restart the system</li> <li>Check which unit is in FAIL mode</li> </ul>	
Same type of slave with same address detected	OFF	5 flashes	5 flashes		OFF	OFF	OFF	OFF	<ul style="list-style-type: none"> <li>Change the unit's address (see NODE SEL)</li> </ul>	
Node detection circuit error	OFF	3 flashes	OFF		3 flashes	OFF	OFF	OFF	OFF	<ul style="list-style-type: none"> <li>Return the unit to ReeR to be repaired</li> </ul>

Table 68 - Troubleshooting MI802

Figure 41 - MI802

MI804 (Figure 42)

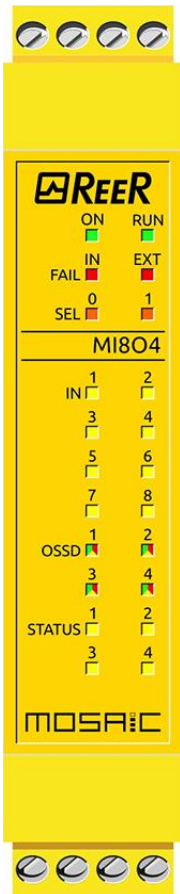

MEANING	LED							REMEDY
	RUN	IN FAIL	EXT FAIL	SELO/1	IN1÷8	OSSD1/4	STATUS1/4	
	GREEN	RED	RED	ORANGE	YELLOW	RED/GREEN/YELLOW	YELLOW	
Internal fault	OFF	2 or 3 flashes	OFF	Shows the physical address of the unit	OFF	Red	OFF	<ul style="list-style-type: none"> <li>Return the unit to Reer to be repaired</li> </ul>
Compatibility error	OFF	5 flashes	OFF		5 flashes	5 flashes	5 flashes	<ul style="list-style-type: none"> <li>Firmware version not compatible with MOSAIC M1, return to Reer for FW upgrade.</li> </ul>
OSSD output error	OFF	4 flashes	OFF		OFF	4 flashes (only the LED corresponding to the output in FAIL mode)	OFF	<ul style="list-style-type: none"> <li>Check OSSD1/2 connections</li> <li>If the problem persists, return the unit to Reer to be repaired</li> </ul>
Error in communication with master	OFF	5 flashes	OFF		OFF	OFF	OFF	<ul style="list-style-type: none"> <li>Restart the system</li> <li>If the problem persists, return the MI804 to Reer to be repaired</li> </ul>
Error on other slave or MOSAIC M1	OFF	ON	OFF		OFF	OFF	OFF	<ul style="list-style-type: none"> <li>Restart the system</li> <li>Check which unit is in FAIL mode</li> </ul>
Same type of slave with same address detected	OFF	5 flashes	5 flashes		OFF	OFF	OFF	<ul style="list-style-type: none"> <li>Change the unit's address (see NODE SEL)</li> </ul>
Overload on OSSD / OSSD load connected to 24V	ON	OFF	ON	Shows the physical address of the unit	Inputs State	Red blinking (only LED corresponding to the relative output)	OUTPUT state	<ul style="list-style-type: none"> <li>Verify OSSD connections</li> </ul>
Short circuit or overload detected on status output	ON	OFF	ON	Shows the physical address of the unit	Inputs State	OUTPUT state	blinking	<ul style="list-style-type: none"> <li>Verify output status connections</li> </ul>

Figure 42 - MI804

Table 69 - Troubleshooting MI804

MI8 (Figure 43)

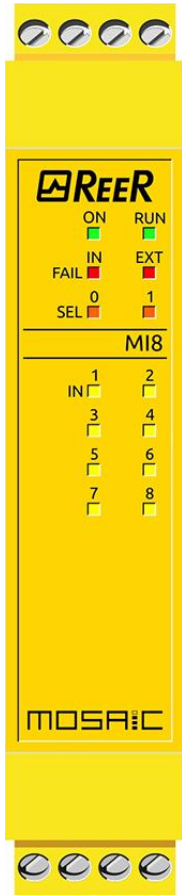

MEANING	LED					REMEDY
	RUN GREEN	IN FAIL RED	EXT FAIL RED	SELO/1 ORANGE	IN1÷8 YELLOW	
Internal fault	OFF	2 or 3 flashes	OFF	Shows the physical address of the unit	OFF	<ul style="list-style-type: none"> <li>Return the unit to ReeR to be repaired</li> </ul>
Compatibility error	OFF	5 flashes	OFF		5 flashes	<ul style="list-style-type: none"> <li>Firmware version not compatible with MOSAIC M1, return to ReeR for FW upgrade.</li> </ul>
Error in communication with master	OFF	5 flashes	OFF		OFF	<ul style="list-style-type: none"> <li>Restart the system</li> <li>If the problem persists, return the unit to ReeR to be repaired</li> </ul>
Error on other slave or MOSAIC M1	OFF	ON	OFF		OFF	<ul style="list-style-type: none"> <li>Restart the system</li> <li>Check which unit is in FAIL mode</li> </ul>
Same type of slave with same address detected	OFF	5 flashes	5 flashes		OFF	<ul style="list-style-type: none"> <li>Change the unit's address (see NODE SEL)</li> </ul>
Node detection circuit error	OFF	3 flashes	OFF		3 flashes	OFF

Table 70 - Troubleshooting MI8

Figure 43 - MI8

## MI12T8 (Figure 44)

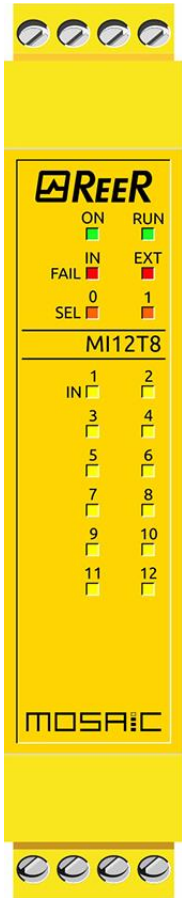

MEANING	LED					REMEDY
	RUN GREEN	IN FAIL RED	EXT FAIL RED	SELO/1 ORANGE	IN1+12 YELLOW	
Internal fault	OFF	2 or 3 flashes	OFF	Shows the physical address of the unit	OFF	Return the unit to ReeR to be repaired
Compatibility error	OFF	5 flashes	OFF		5 flashes	<ul style="list-style-type: none"> <li>Firmware version not compatible with MOSAIC M1, return to ReeR for FW upgrade.</li> </ul>
Error in communication with master	OFF	5 flashes	OFF		OFF	<ul style="list-style-type: none"> <li>Restart the system</li> <li>If the problem persists, return the unit to ReeR to be repaired</li> </ul>
Error on other slave or MOSAIC M1	OFF	ON	OFF		OFF	<ul style="list-style-type: none"> <li>Restart the system</li> <li>Check which unit is in FAIL mode</li> </ul>
Same type of slave with same address detected	OFF	5 flashes	5 flashes		OFF	<ul style="list-style-type: none"> <li>Change the unit's address (see NODE SEL)</li> </ul>
Node detection circuit error	OFF	3 flashes	OFF		3 flashes	OFF

Table 71 - Troubleshooting MI12T8

Figure 44 - MI12T8



MI16 (Figure 45)

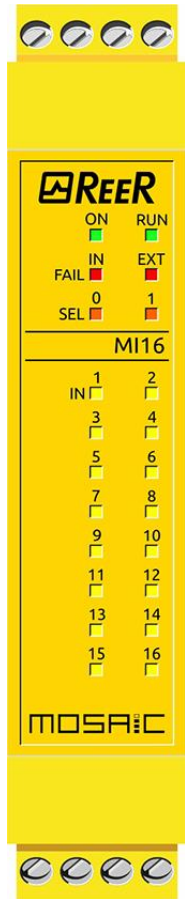

Figure 45 - MI16

MEANING	LED					REMEDY
	RUN	IN FAIL	EXT FAIL	SELO/1	IN1÷16	
	GREEN	RED	RED	ORANGE	YELLOW	
Internal fault	OFF	2 or 3 flashes	OFF	Shows the physical address of the unit	OFF	<ul style="list-style-type: none"> <li>Return the unit to ReeR to be repaired</li> </ul>
Compatibility error	OFF	5 flashes	OFF		5 flashes	<ul style="list-style-type: none"> <li>Firmware version not compatible with MOSAIC M1, return to ReeR for FW upgrade.</li> </ul>
Error in communication with master	OFF	5 flashes	OFF		OFF	<ul style="list-style-type: none"> <li>Restart the system</li> <li>If the problem persists, return the unit to ReeR to be repaired</li> </ul>
Error on other slave or MOSAIC M1	OFF	ON	OFF		OFF	<ul style="list-style-type: none"> <li>Restart the system</li> <li>Check which unit is in FAIL mode</li> </ul>
Same type of slave with same address detected	OFF	5 flashes	5 flashes		OFF	<ul style="list-style-type: none"> <li>Change the unit's address (see NODE SEL)</li> </ul>
Node detection circuit error	OFF	3 flashes	OFF		3 flashes	OFF

Table 72 - Troubleshooting MI16

MO2 / MO4 (Figure 46)

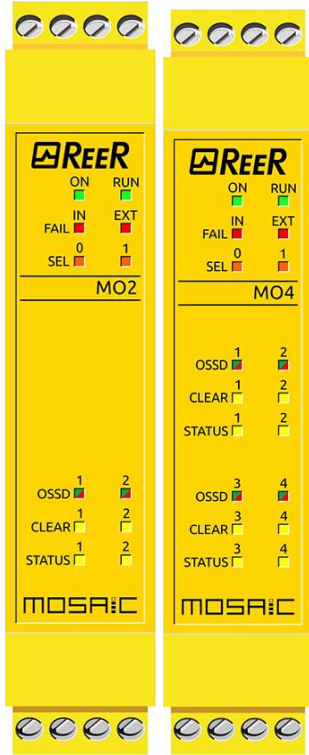

Figure 46 - MO2 / MO4

MEANING	LED							REMEDY	
	RUN	IN FAIL	EXT FAIL	SEL0/1	OSSD1/4	CLEAR1/4	STATUS1/4		
	GREEN	RED	RED	ORANGE	RED/GREEN	YELLOW	YELLOW		
Internal fault	OFF	2 or 3 flashes	OFF	Shows the physical address of the unit	Red	OFF	OFF	Return the unit to ReeR to be repaired	
Compatibility error	OFF	5 flashes	OFF		5 flashes	5 flashes	5 flashes	<ul style="list-style-type: none"> <li>Firmware version not compatible with MOSAIC M1, return to ReeR for FW upgrade.</li> </ul>	
OSSD output error	OFF	4 flashes	OFF		4 flashes (only the LED corresponding to the output in FAIL mode)	OFF	OFF	<ul style="list-style-type: none"> <li>Check OSSD1/2 connections</li> <li>If the problem persists, return the unit to ReeR to be repaired</li> </ul>	
Error in communication with master	OFF	5 flashes	OFF		OFF	OFF	OFF	<ul style="list-style-type: none"> <li>Restart the system</li> <li>If the problem persists, return the unit to ReeR to be repaired</li> </ul>	
Error on other slave or MOSAIC M1	OFF	ON	OFF		OFF	OFF	OFF	<ul style="list-style-type: none"> <li>Restart the system</li> <li>Check which unit is in FAIL mode</li> </ul>	
Same type of slave with same address detected	OFF	5 flashes	5 flashes		OFF	OFF	OFF	<ul style="list-style-type: none"> <li>Change the unit's address (see NODE SEL)</li> </ul>	
Power supply missing on OSSD 3,4 (MO4 only)	ON	OFF	ON		Red flashes	flashes	OUTPUT condition	<ul style="list-style-type: none"> <li>Connect 13 and 14 pin to power supply</li> </ul>	
Status output overload or short circuit	OFF	OFF	ON		OUTPUT condition	CLEAR condition	flashes	<ul style="list-style-type: none"> <li>Check STATUS connections</li> </ul>	
Error on node detection circuit	OFF	3 flashes	OFF		3 flashes	OFF	OFF	OFF	<ul style="list-style-type: none"> <li>Return the MO2/4 to ReeR to be repaired</li> </ul>

Table 73 - Troubleshooting MO2/MO4

MO4L (Figure 47)

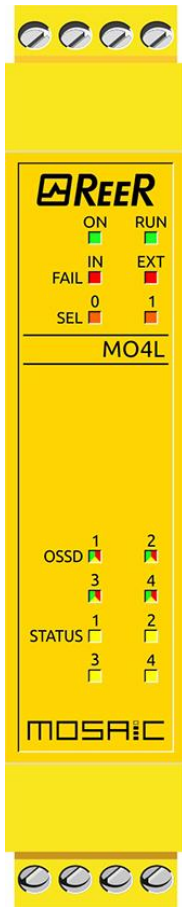
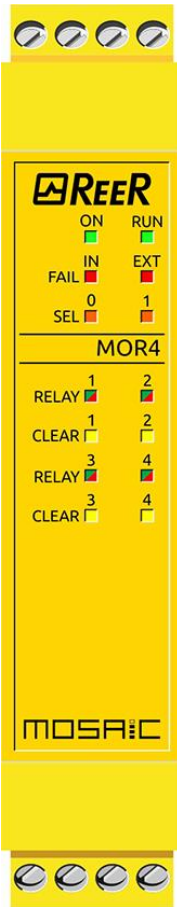

Figure 47 - MO4L

MEANING	LED						REMEDY
	RUN	IN FAIL	EXT FAIL	SEL0/1	OSSD1/4	STATUS1/4	
	GREEN	RED	RED	ORANGE	RED/GREEN/YELLOW	YELLOW	
Internal fault	OFF	2 or 3 flashes	OFF	Shows the physical address of the unit	Red	OFF	<ul style="list-style-type: none"> <li>Return the unit to ReeR to be repaired</li> </ul>
Compatibility error	OFF	5 flashes	OFF		5 flashes	5 flashes	<ul style="list-style-type: none"> <li>Firmware version not compatible with MOSAIC M1, return to ReeR for FW upgrade.</li> </ul>
OSSD output error	OFF	4 flashes	OFF		4 flashes (only the LED corresponding to the output in FAIL mode)	OFF	<ul style="list-style-type: none"> <li>Check OSSD1/2 connections</li> <li>If the problem persists, return the unit to ReeR to be repaired</li> </ul>
Error in communication with master	OFF	5 flashes	OFF		OFF	OFF	<ul style="list-style-type: none"> <li>Restart the system</li> <li>If the problem persists, return the MO4L to ReeR to be repaired</li> </ul>
Error on other slave or MOSAIC M1	OFF	ON	OFF		OFF	OFF	<ul style="list-style-type: none"> <li>Restart the system</li> <li>Check which unit is in FAIL mode</li> </ul>
Same type of slave with same address detected	OFF	5 flashes	5 flashes		OFF	OFF	<ul style="list-style-type: none"> <li>Change the unit's address (see NODE SEL)</li> </ul>
Overload on OSSD / OSSD load connected to 24V	ON	OFF	ON		Shows the physical address of the unit	Red blinking (only LED corresponding to the relative output)	OUTPUT state
Short circuit or overload detected on status output	ON	OFF	ON	Shows the physical address of the unit	OUTPUT state	blinking	<ul style="list-style-type: none"> <li>Verify output status connections</li> </ul>

Table 74 - Troubleshooting MO4L

## MOR4 (Figure 48)



MEANING	LED							REMEDY	
	RUN	IN FAIL	EXT FAIL	SEL 0/1	RELAY 1/4		CLEAR1/4		
	GREEN	RED	RED	ORANGE	RED	GREEN	YELLOW		
Internal fault	OFF	2 / 3 flashes	OFF	Shows the physical address of the unit	Rosso		OFF	<ul style="list-style-type: none"> <li>Return the unit to Reer to be repaired</li> </ul>	
Compatibility error	OFF	5 flashes	OFF		5 flashes		5 flashes	<ul style="list-style-type: none"> <li>Firmware version not compatible with MOSAIC M1, return to Reer for FW upgrade.</li> </ul>	
Relais output error	OFF	4 flashes	OFF		4 flashes (only the LED corresponding to the output in FAIL mode)		OFF	<ul style="list-style-type: none"> <li>If the problem persists, return the module to Reer to be repaired</li> </ul>	
Error in communication with master	OFF	5 flashes	OFF		OFF		OFF	<ul style="list-style-type: none"> <li>Restart the system</li> <li>If the problem persists, return the module to Reer to be repaired</li> </ul>	
Error on other slave or MOSAIC M1	OFF	ON	OFF		OFF		OFF	<ul style="list-style-type: none"> <li>Restart the system</li> <li>Check which unit is in FAIL mode</li> </ul>	
Same type of slave with same address detected	OFF	5 flashes	5 flashes		OFF		OFF	<ul style="list-style-type: none"> <li>Change the unit's address (see NODE SEL)</li> </ul>	
External contactors feedback error on Category 4 relay	ON	OFF	4 flashes		4 flashes (only the LEDs corresponding to the outputs in FAIL mode)			<ul style="list-style-type: none"> <li>Verify connections 5,6,7,8.</li> </ul>	
Error on node detection circuit	OFF	3 flashes	OFF		3 flashes	OFF		OFF	<ul style="list-style-type: none"> <li>Return the module to Reer to be repaired</li> </ul>

Table 75 - Troubleshooting MOR4

Figure 48 - MOR4

MOR4S8 (Figure 49)

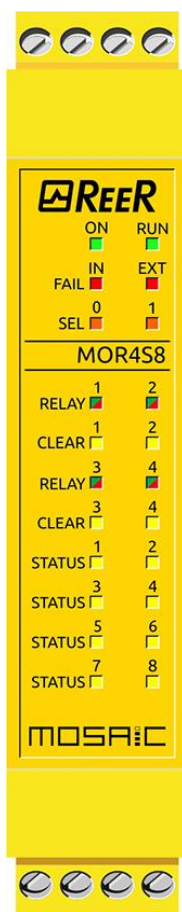

Figure 49 - MOR4S8

MEANING	LED								REMEDY	
	RUN	IN FAIL	EXT FAIL	SELO/1	RELAY 1/4		CLEAR1/4	STATUS1/8		
	GREEN	RED	RED	ORANGE	RED	GREEN	YELLOW	YELLOW		
Internal fault	OFF	2 / 3 flashes	OFF	Shows the physical address of the unit	Rosso		OFF		<ul style="list-style-type: none"> <li>Return the unit to Reer to be repaired</li> </ul>	
Compatibility error	OFF	5 flashes	OFF		5 flashes		5 flashes	5 flashes	<ul style="list-style-type: none"> <li>Firmware version not compatible with MOSAIC M1, return to Reer for FW upgrade.</li> </ul>	
Relais output error	OFF	4 flashes	OFF		4 flashes (only the LED corresponding to the output in FAIL mode)		OFF	OFF	<ul style="list-style-type: none"> <li>If the problem persists, return the module to Reer to be repaired</li> </ul>	
Error in communication with master	OFF	5 flashes	OFF		OFF		OFF	OFF	<ul style="list-style-type: none"> <li>Restart the system</li> <li>If the problem persists, return the module to Reer to be repaired</li> </ul>	
Error on other slave or MOSAIC M1	OFF	ON	OFF		OFF		OFF	OFF	<ul style="list-style-type: none"> <li>Restart the system</li> <li>Check which unit is in FAIL mode</li> </ul>	
Same type of slave with same address detected	OFF	5 flashes	5 flashes		OFF		OFF	OFF	<ul style="list-style-type: none"> <li>Change the unit's address (see NODE SEL)</li> </ul>	
External contactors feedback error on Category 4 relay	ON	OFF	4 flashes		4 flashes (only the LEDs corresponding to the outputs in FAIL mode)			OFF	<ul style="list-style-type: none"> <li>Verify connections 5,6,7,8.</li> </ul>	
Error on node detection circuit	OFF	3 flashes	OFF		3 flashes	OFF		OFF	OFF	<ul style="list-style-type: none"> <li>Return the module to Reer to be repaired</li> </ul>
Short circuit or overload detected on status output	OFF	OFF	ON		OFF	OUTPUT condition		CLEAR condition	flash	<ul style="list-style-type: none"> <li>Verify output status connections</li> </ul>

Table 76 - Troubleshooting MOR4S8

MOS8 (Figure 50)

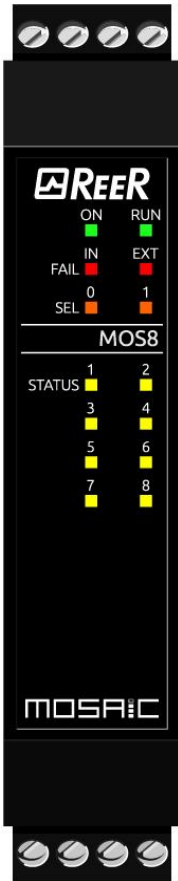

Figure 50 – MOS8

MEANING	LED					REMEDY	
	RUN	IN FAIL	EXT FAIL	SELO/1	STATUS1/8		
	GREEN	RED	RED	ORANGE	YELLOW		
Internal fault	OFF	2 / 3 flashes	OFF	Shows the physical address of the unit	OFF	<ul style="list-style-type: none"> <li>Return the unit to Reer to be repaired</li> </ul>	
Compatibility error	OFF	5 flashes	OFF		5 flashes	<ul style="list-style-type: none"> <li>Firmware version not compatible with MOSAIC M1, return to Reer for FW upgrade.</li> </ul>	
Error in communication with master	OFF	5 flashes	OFF		OFF	<ul style="list-style-type: none"> <li>Restart the system</li> <li>If the problem persists, return the module to Reer to be repaired</li> </ul>	
Error on other slave or MOSAIC M1	OFF	ON	OFF		OFF	<ul style="list-style-type: none"> <li>Restart the system</li> <li>Check which unit is in FAIL mode</li> </ul>	
Same type of slave with same address detected	OFF	5 flashes	5 flashes		OFF	<ul style="list-style-type: none"> <li>Change the unit's address (see NODE SEL)</li> </ul>	
Error on node detection circuit	OFF	3 flashes	OFF		3 flashes	OFF	<ul style="list-style-type: none"> <li>Return the module to Reer to be repaired</li> </ul>
Short circuit or overload detected on status 1-8 output	OFF	OFF	ON		OFF	flash	<ul style="list-style-type: none"> <li>Verify output status 1-8 connections</li> </ul>
Power supply missing on status 1-8 output	OFF	OFF	ON		OFF	flash alternatively	<ul style="list-style-type: none"> <li>Connect 5 pin to power supply</li> </ul>

Table 77 - Troubleshooting MOS8

MOS16 (Figure 51)

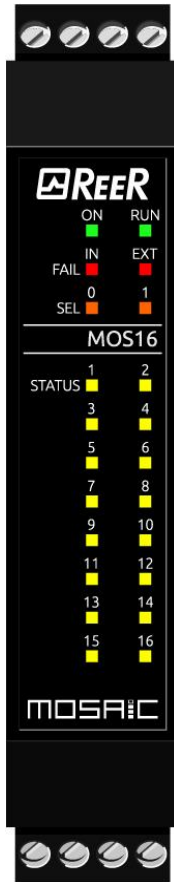

Figure 51 - MOS16

MEANING	LED						REMEDY	
	RUN	IN FAIL	EXT FAIL	SELO/1	STATUS1/8	STATUS9/16		
	GREEN	RED	RED	ORANGE	YELLOW	YELLOW		
Internal fault	OFF	2 / 3 flashes	OFF	Shows the physical address of the unit	OFF	OFF	<ul style="list-style-type: none"> <li>Return the unit to ReeR to be repaired</li> </ul>	
Compatibility error	OFF	5 flashes	OFF		5 flashes	5 flashes	<ul style="list-style-type: none"> <li>Firmware version not compatible with MOSAIC M1, return to ReeR for FW upgrade.</li> </ul>	
Error in communication with master	OFF	5 flashes	OFF		OFF	OFF	<ul style="list-style-type: none"> <li>Restart the system</li> <li>If the problem persists, return the module to ReeR to be repaired</li> </ul>	
Error on other slave or MOSAIC M1	OFF	ON	OFF		OFF	OFF	<ul style="list-style-type: none"> <li>Restart the system</li> <li>Check which unit is in FAIL mode</li> </ul>	
Same type of slave with same address detected	OFF	5 flashes	5 flashes		OFF	OFF	<ul style="list-style-type: none"> <li>Change the unit's address (see NODE SEL)</li> </ul>	
Error on node detection circuit	OFF	3 flashes	OFF		3 flashes	OFF	OFF	<ul style="list-style-type: none"> <li>Return the module to ReeR to be repaired</li> </ul>
Short circuit or overload detected on status 1-8 output	OFF	OFF	ON		OFF	flash	OFF	<ul style="list-style-type: none"> <li>Verify output status 1-8 connections</li> </ul>
Short circuit or overload detected on status 9-16 output	OFF	OFF	ON	OFF	OFF	flash	<ul style="list-style-type: none"> <li>Verify output status 9-16 connections</li> </ul>	
Power supply missing on status 1-8 output	OFF	OFF	ON	OFF	flash alternatively	OFF	<ul style="list-style-type: none"> <li>Connect 5 pin to power supply</li> </ul>	
Power supply missing on status 9-16 output	OFF	OFF	ON	OFF	OFF	flash alternatively	<ul style="list-style-type: none"> <li>Connect 6 pin to power supply</li> </ul>	

Table 78 - Troubleshooting MOS16

MV0, MV1, MV2 (Figure 52)

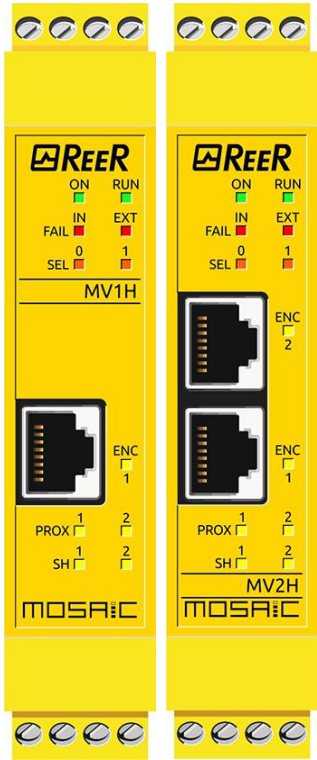

Figure 52 - MV1, MV2

MEANING	LED							REMEDY
	RUN	IN FAIL	EXT FAIL	SEL0/1	ENC*	PROX	SH	
	GREEN	RED	RED	ORANGE	YELLOW	YELLOW	YELLOW	
Internal fault	OFF	2 or 3 flashes	OFF	Shows the physical address of the unit	OFF	OFF	OFF	<ul style="list-style-type: none"> <li>Return the unit to Reer to be repaired</li> </ul>
Compatibility error	OFF	5 flashes	OFF		5 flashes	5 flashes	5 flashes	<ul style="list-style-type: none"> <li>Firmware version not compatible with MOSAIC M1, return to Reer for FW upgrade.</li> </ul>
Encoder INTERNAL error	OFF	3 flashes	OFF		3 flashes	OFF	OFF	<ul style="list-style-type: none"> <li>Change the encoder</li> <li>Return the unit to Reer to be repaired</li> </ul>
Proximity INTERNAL error	OFF	3 flashes	OFF		3 flashes	3 flashes	OFF	<ul style="list-style-type: none"> <li>Change the proximity</li> <li>Return the unit to Reer to be repaired</li> </ul>
Error on node detection circuit	OFF	3 flashes	OFF	3 flashes	OFF	OFF	OFF	<ul style="list-style-type: none"> <li>Return the unit to Reer to be repaired</li> </ul>
Same type of slave with same address detected	OFF	5 flashes	5 flashes	Shows the physical address of the unit	OFF	OFF	OFF	<ul style="list-style-type: none"> <li>Change the unit's address (see NODE SEL)</li> </ul>
Encoder not connected but requested from the configuration	OFF	OFF	continuous flashes		continuous flashes	OFF	OFF	<ul style="list-style-type: none"> <li>Verify encoder connection and power supply</li> <li>Verify input frequency (in range)</li> </ul>
Proximity not connected but requested from the configuration	OFF	OFF	continuous flashes		OFF	continuous flashes	OFF	<ul style="list-style-type: none"> <li>Verify proximity connection</li> <li>Verify input frequency (in range)</li> </ul>

Table 79 - Troubleshooting MV1/MV2

\* NOT PRESENT ON MV0 MODULE



MO4LHCS8 (Figure 53)

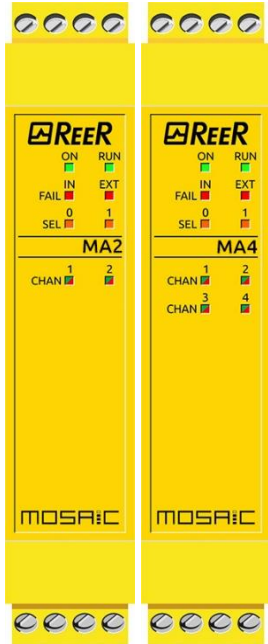

Figure 53 - MO4LHCS8

MEANING	LED								REMEDY
	RUN GREEN	IN FAIL RED	EXT FAIL RED	SEL 0/1 ORANGE	OSSD 1/4		CLEAR1/4 YELLOW	STATUS1/8 YELLOW	
Internal fault	OFF	2 / 3 flashes	OFF	Shows the physical address of the unit	Rosso		OFF		<ul style="list-style-type: none"> <li>Return the unit to ReeR to be repaired</li> </ul>
Compatibility error	OFF	5 flashes	OFF		5 flashes		5 flashes	5 flashes	<ul style="list-style-type: none"> <li>Firmware version not compatible with MOSAIC M1, return to ReeR for FW upgrade.</li> </ul>
OSSD output error	OFF	4 flashes	OFF		4 flashes (only the LED corresponding to the output in FAIL mode)		OFF	OFF	<ul style="list-style-type: none"> <li>If the problem persists, return the module to ReeR to be repaired</li> </ul>
Error in communication with master	OFF	5 flashes	OFF		OFF		OFF	OFF	<ul style="list-style-type: none"> <li>Restart the system</li> <li>If the problem persists, return the module to ReeR to be repaired</li> </ul>
Error on other slave or MOSAIC M1	OFF	ON	OFF		OFF		OFF	OFF	<ul style="list-style-type: none"> <li>Restart the system</li> <li>Check which unit is in FAIL mode</li> </ul>
Same type of slave with same address detected	OFF	5 flashes	5 flashes		OFF		OFF	OFF	<ul style="list-style-type: none"> <li>Change the unit's address (see NODE SEL)</li> </ul>
Short circuit or overload detected on status output	ON	OFF	ON		OUTPUT condition		CLEAR condition	flash	<ul style="list-style-type: none"> <li>Verify output status connections</li> </ul>
OSSD overload or load connected to 24VDC	ON	OFF	ON		Blinking (only LED corresponding to the relative output)		OFF	OUTPUT condition	<ul style="list-style-type: none"> <li>Verify OSSD connections</li> </ul>
Power supply missing on OSSD3-OSSD4	ON	OFF	ON		OSSD3/OSSD4 led blinking		OSSD3/OSSD4 led blinking	OUTPUT condition	<ul style="list-style-type: none"> <li>Connect pin 14 to 24VDC</li> </ul>
Error on node detection circuit	OFF	3 flashes	OFF		3 flashes	OFF		OFF	OFF

Table 80 - Troubleshooting MO4LHCS8

MA2, MA4 (Figure 54)

 Figure 54 –  
MA2, MA4

MEANING	LED						REMEDY
	RUN	IN FAIL	EXT FAIL	SELO/1	CHAN 1/4		
	GREEN	RED	RED	ORANGE	RED	GREEN	
Internal fault	OFF	2 / 3 flashes	OFF	Shows the physical address of the unit	OFF	OFF	<ul style="list-style-type: none"> <li>Return the unit to ReeR to be repaired</li> </ul>
Compatibility error	OFF	3 flashes	OFF		OFF	OFF	<ul style="list-style-type: none"> <li>Wrong MASTER firmware version, return MASTER unit to ReeR in order to update the firmware.</li> </ul>
Communication error with MASTER	OFF	5 flashes	OFF		OFF	OFF	<ul style="list-style-type: none"> <li>Reboot the system</li> <li>If reboot does not work return the unit to ReeR</li> </ul>
Error on other slave or MASTER	OFF	ON	OFF		OFF	OFF	<ul style="list-style-type: none"> <li>Restart the system</li> <li>Check which unit is in FAIL mode</li> </ul>
Same type of slave with same address detected	OFF	5 flashes	5 flashes		OFF	OFF	<ul style="list-style-type: none"> <li>Change the unit address (see NODE SEL)</li> </ul>
Wrong configuration received	OFF	5 flashes	OFF		OFF	OFF	<ul style="list-style-type: none"> <li>Check field bus connection.</li> </ul>

**Channel configured as SINGLE or not configured at all**

Sensor supply overload	ON	OFF	ON	Shows the physical address of the unit	1 flash every 600 ms	OFF	<ul style="list-style-type: none"> <li>Check sensor connections</li> <li>Check sensor status</li> </ul>
Input channel overload	ON	OFF	ON		1 flash every 600 ms	OFF	<ul style="list-style-type: none"> <li>Check sensor connections</li> <li>Check sensor status</li> </ul>
Read value over threshold	ON	OFF	ON		3 fast flashes and a pause of 600 ms	OFF	<ul style="list-style-type: none"> <li>Check sensor connections</li> <li>Check sensor status</li> <li>Check threshold values set with MSD software</li> </ul>
Read value under threshold	ON	OFF	ON		3 fast flashes and a pause of 600 ms	OFF	<ul style="list-style-type: none"> <li>Check sensor connections</li> <li>Check sensor status</li> <li>Check threshold values set with MSD software</li> </ul>
Disconnected sensor	ON	OFF	ON		3 fast flashes and a pause of 600 ms	OFF	<ul style="list-style-type: none"> <li>Check sensor connections</li> <li>Check sensor status</li> </ul>

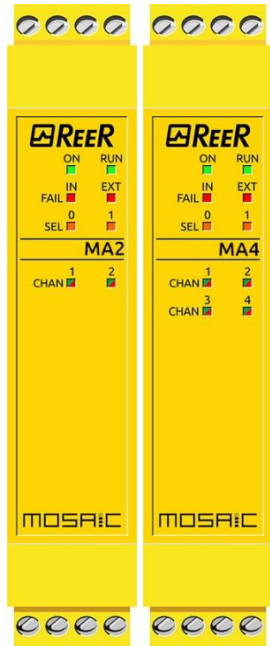

MA2, MA4

<b>Channel configured as Redundant (Pair of sensors connected), conditions:</b>							
1. <u>Sensor supply overload. Input channel overload. Read value over threshold. Read value under threshold. Disconnected sensor:</u> When one of these diagnosis is detected the RED led relative to the channel with the problem will flash. The RED led of the other channel remains ON (no flash). If one of the above diagnosis is detected at the same time on both sensors the RED led of the second channel will flash while the RED led of the first channel remains ON (no flash). 2. <u>Read value from sensor pair out of tolerance diagnosis:</u> both LEDs of channel pair will flash.							
MEANING	LED						REMEDY
	RUN GREEN	IN FAIL RED	EXT FAIL RED	SELO/1 ORANGE	CHAN 1/4		
					RED	GREEN	
Sensor supply overload	ON	OFF	ON	Shows the physical address of the unit	1 flash every 600 ms	OFF	<ul style="list-style-type: none"> <li>• Check sensor connections</li> <li>• Check sensor status</li> </ul>
Input channel overload	ON	OFF	ON		1 flash every 600 ms	OFF	<ul style="list-style-type: none"> <li>• Check sensor connections</li> <li>• Check sensor status</li> </ul>
Read value over threshold	ON	OFF	ON		3 fast flashes and a pause of 600 ms	OFF	<ul style="list-style-type: none"> <li>• Check sensor connections</li> <li>• Check sensor status</li> <li>• Check threshold values set with MSD software</li> </ul>
Read value under threshold	ON	OFF	ON		3 fast flashes and a pause of 600 ms	OFF	<ul style="list-style-type: none"> <li>• Check sensor connections</li> <li>• Check sensor status</li> <li>• Check threshold values set with MSD software</li> </ul>
Disconnected sensor	ON	OFF	ON		3 fast flashes and a pause of 600 ms	OFF	<ul style="list-style-type: none"> <li>• Check sensor connections</li> <li>• Check sensor status</li> </ul>
Read value from sensor pair out of tolerance	ON	OFF	ON		1 flash every 100 ms	OFF	<ul style="list-style-type: none"> <li>• Check sensor connections</li> <li>• Check sensor status</li> <li>• Check values set with MSD software</li> </ul>

Table 81 - Troubleshooting MA4

---

## MOSAIC SAFETY DESIGNER SOFTWARE

---

The "MOSAIC SAFETY DESIGNER" application software can be used to configure a logic diagram of the connections between the MOSAIC (Master + expansions) and the components of the system being developed.

The MOSAIC and its SLAVE units will thus monitor and control the connected safety components.

The MSD uses a versatile graphic interface to establish the connections between the various components, as described below:

---

### Installing the software

---

---

#### PC HARDWARE requirements

---

- RAM: > 2 GB
- Hard disk: > 500MB of free space
- USB connector: 2.0 or higher
- Internet connection for program download

---

#### PC SOFTWARE requirements

---

- Windows 7 with Service Pack 1 installed (or higher OS).
- Microsoft Framework 4.8 (or higher).

---

#### Installation of MSD software

---

- Download the last available version from the Download section of the ReeR website: <https://www.reersafety.com/it/en/download/configuration-software>.
- **Run the "SetupDesigner.exe" file.**
- Wait for the auto-run installer to request the SW setup program.

➔ When the installation procedure is complete a window is displayed asking you to close the setup program.

Fundamentals

Once the MSD has been correctly installed it creates an icon on the desktop.  
 To launch the program: double-click on this icon. =>  
 The opening screen shown below is displayed:

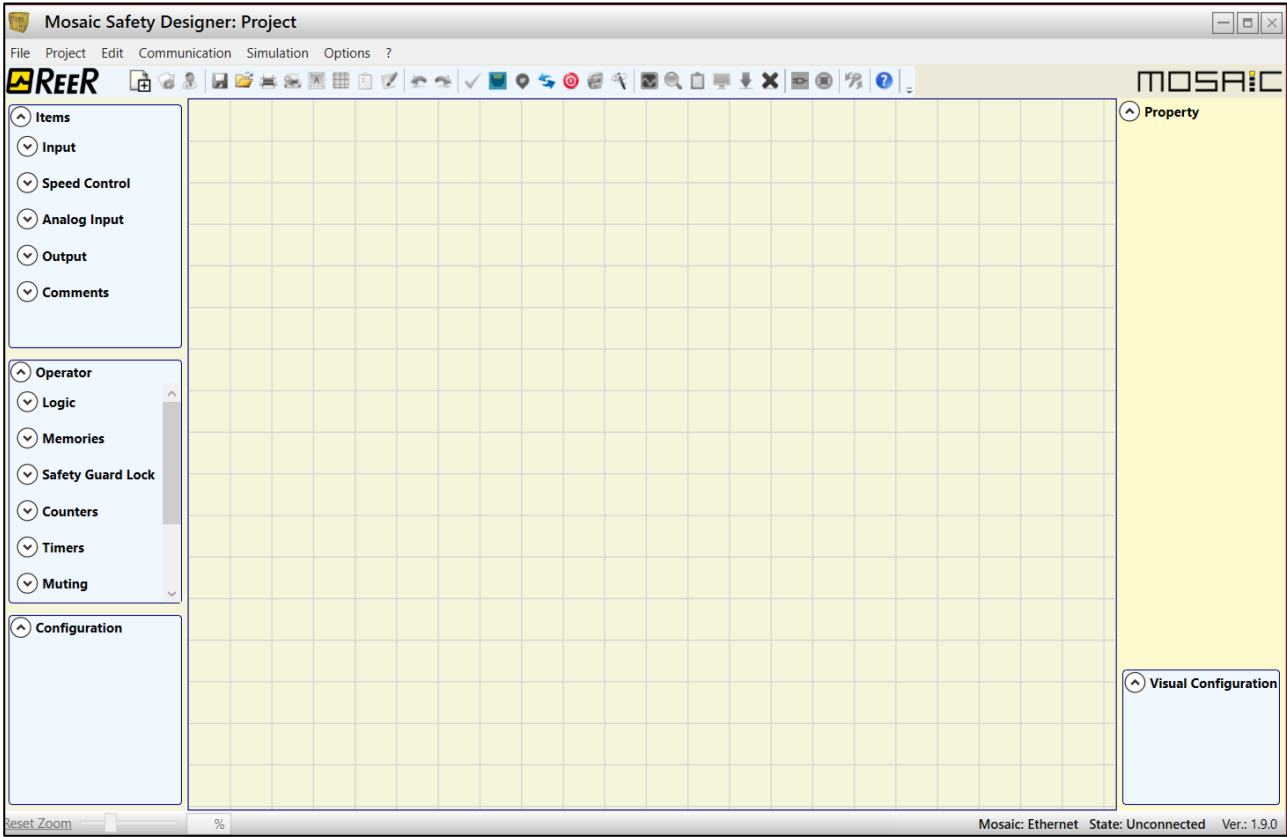

Figure 55

You are now ready to create your project.

## Standard toolbar

The standard toolbar is shown in Figure 56. The meanings of the icons are listed below:



Figure 56

- |       |  |                                                                  |
|-------|--|------------------------------------------------------------------|
| 1 ->  |  | CREATE A NEW PROJECT                                             |
| 2 ->  |  | CHANGE CONFIGURATION (composition of different modules)          |
| 3 ->  |  | CHANGE USER PARAMETERS (name, company, etc)                      |
| 4 ->  |  | SAVE THE ACTUAL PROJECT                                          |
| 5 ->  |  | LOAD AN EXISTING PROJECT (FROM THE PC)                           |
| 6 ->  |  | PRINT THE PROJECT SCHEMATIC                                      |
| 7 ->  |  | PRINT PREVIEW                                                    |
| 8 ->  |  | PRINTING AREA                                                    |
| 9 ->  |  | SNAP TO GRID                                                     |
| 10 -> |  | RESOURCES ALLOCATION                                             |
| 11 -> |  | PRINT THE PROJECT REPORT                                         |
| 12 -> |  | UNDO (CANCEL THE LAST COMMAND)                                   |
| 13 -> |  | REDO (RESTORE THE LAST CANCELLATION)                             |
| 14 -> |  | VALIDATE THE PROJECT                                             |
| 15 -> |  | CHANNEL SELECTION                                                |
| 16 -> |  | NETWORK PARAMETERS (MOSAIC M1S COM only)                         |
| 17 -> |  | CONNECT TO MOSAIC                                                |
| 18 -> |  | DOWNLOAD PROJECT TO MOSAIC (FROM PC)                             |
| 19 -> |  | DISCONNECT FROM MOSAIC                                           |
| 20 -> |  | UPLOAD AN EXISTING PROJECT TO PC (FROM MOSAIC)                   |
| 21 -> |  | MONITOR (Real time I/O status - graphic)                         |
| 22 -> |  | MONITOR (Real time I/O status - textual)                         |
| 23 -> |  | CONFIGURATIONS LOG                                               |
| 24 -> |  | SHOW SYSTEM CONFIGURATION                                        |
| 25 -> |  | ERRORS LOG                                                       |
| 26 -> |  | DELETE ERRORS LOG                                                |
| 27 -> |  | SCHEMATIC SIMULATION                                             |
| 28 -> |  | GRAPHIC SIMULATION                                               |
| 29 -> |  | CHANGE PASSWORD                                                  |
| 30 -> |  | HELP ON-LINE                                                     |
| 31 -> |  | PASSWORD RECOVERY (not displayed in the standard operation mode) |

Textual toolbar

Optionally the textual toolbar shown below is also available (drop down).



Figure 57

Create a new project (configure the MOSAIC system)

Select icon CREATE  (Figure 56) from the standard toolbar to start a new project. The user authentication window is displayed (Figure 58).

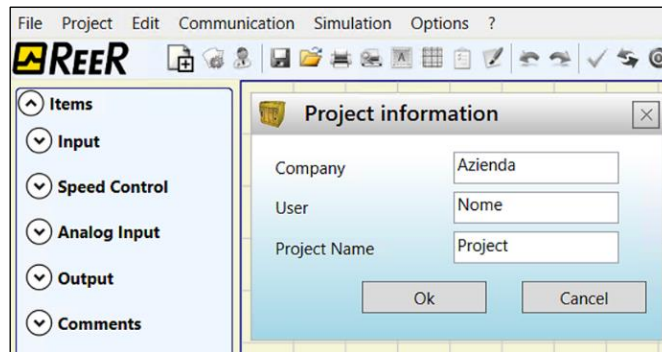

Figure 58

Next the MSD displays a window showing the MOSAIC M1S only. It is possible to select the MOSAIC M1, MOSAIC M1S COM modules acting on the drop-down menu under the master module choosing the fw version. For MOSAIC M1 it is <5.0; for MOSAIC M1S it is  $\geq 5.0$  and <7; for MOSAIC M1S COM it is  $\geq 7.0$ .

You may add the various units needed to create your system, using the drop-down menus at the top of the screen (select slave) and at the bottom to select the relative node (0÷3).

The insertion order of modules is not important. Also the physical position of the modules must not be the same of the msd configuration menu. For example, you can physically put the slave modules to the left of the master module.

For some slave modules, it is also necessary to choose the type (MVx, MBx) by means of a second drop-down menu located below the node selection menu.

SELECT SLAVE (to add to your configuration)

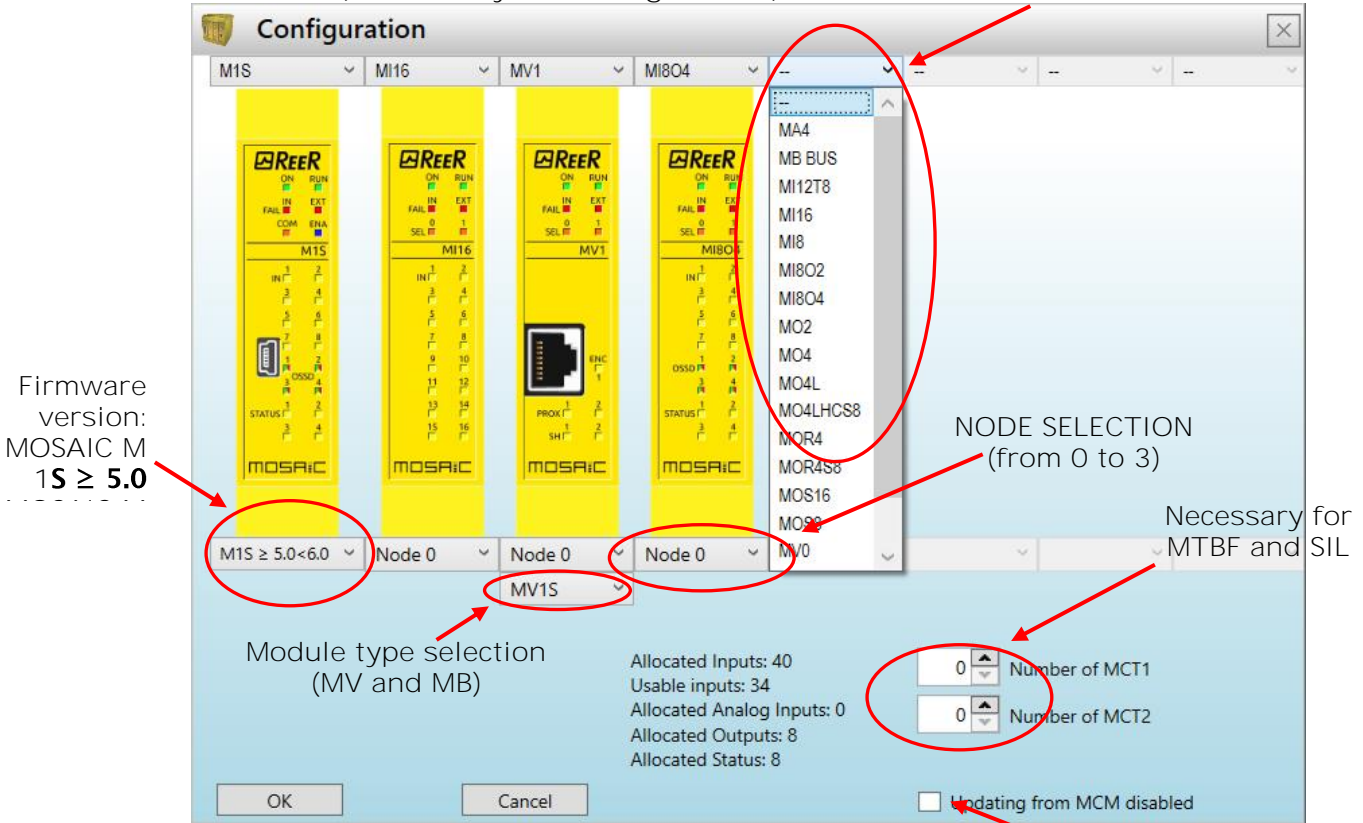

Figure 59  
MOSAIC M1 / MOSAIC M1S project configuration

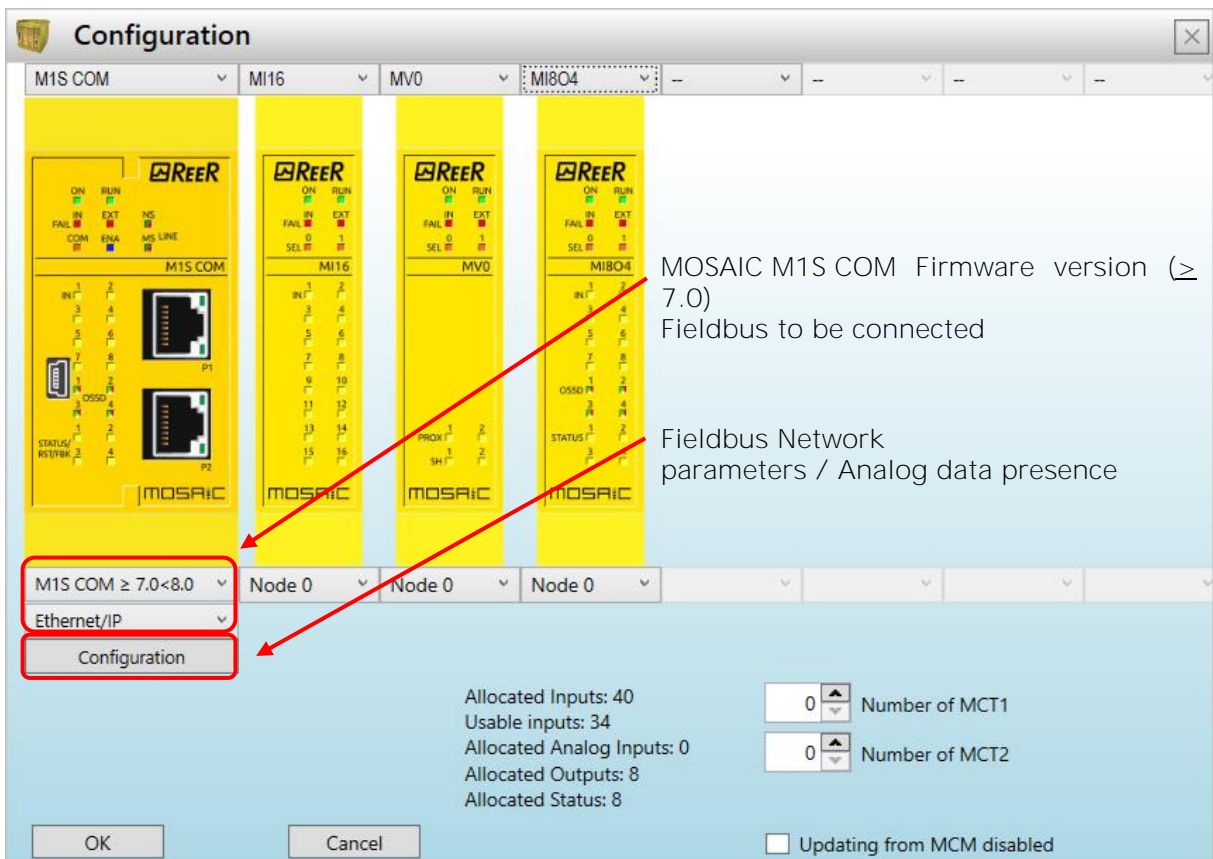

Figure 60 - MOSAIC M1S COM project configuration

english



Create a new project: MOSAIC M1S COM fieldbus parameters configuration

**ModBus TCP parameters**

When MOSAIC M1S COM has to be connected with a ModBus TCP fieldbus you can choose if the stack automatically set the LAN parameters (DHCP active) or (selecting "Manual") directly complete the necessary network parameters: IP Address, Subnet Mask, Default Gateway.

- ➔ "Disable FieldBus analog data" will deactivate the transmission of MA2/MA4 analog data.
- ➔ Please note that the selection of this tick is a function of the process map (if "Disable FieldBus analog data" is selected, a process map without analog data must be used).
- ➔ Clicking on "Read" enables MSD to compile the network parameters by reading them from those set on the connected MOSAIC M1S COM master. The required parameters must be those of the currently loaded fieldbus. For example, if the connected module is ModBus TCP and you try to read the network parameters by setting Profinet RT as "Configuration" then reading will not be enabled.

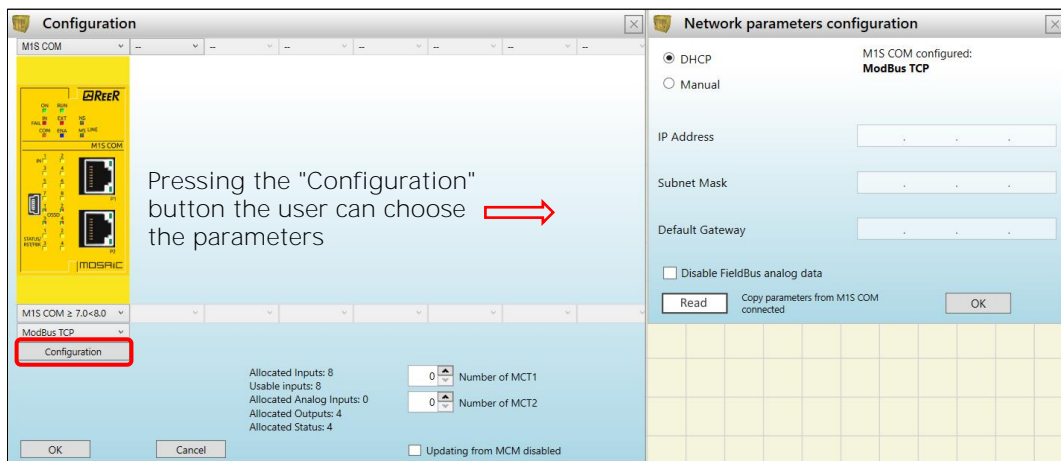

Figure 61

**EtherNet/IP parameters**

When MOSAIC M1S COM has to be connected with EtherNet/IP fieldbus you can choose if the stack automatically set the LAN parameters (DHCP active) or (selecting "Manual") directly complete the necessary network parameters: IP Address, Subnet Mask, Default Gateway, DNS1, DNS2, Station Name (optional).

- ➔ "Disable FieldBus analog data" will deactivate the transmission of MA2/MA4 analog data.
- ➔ Please note that the selection of this tick is a function of the process map (if "Disable FieldBus analog data" is selected, a process map without analog data must be used).
- ➔ Clicking on "Read" enables MSD to compile the network parameters by reading them from those set on the connected MOSAIC M1S COM master. The required parameters must be those of the currently loaded fieldbus. For example, if the connected module is ModBus TCP and you try to read the network parameters by setting Profinet RT as "Configuration" then reading will not be enabled.

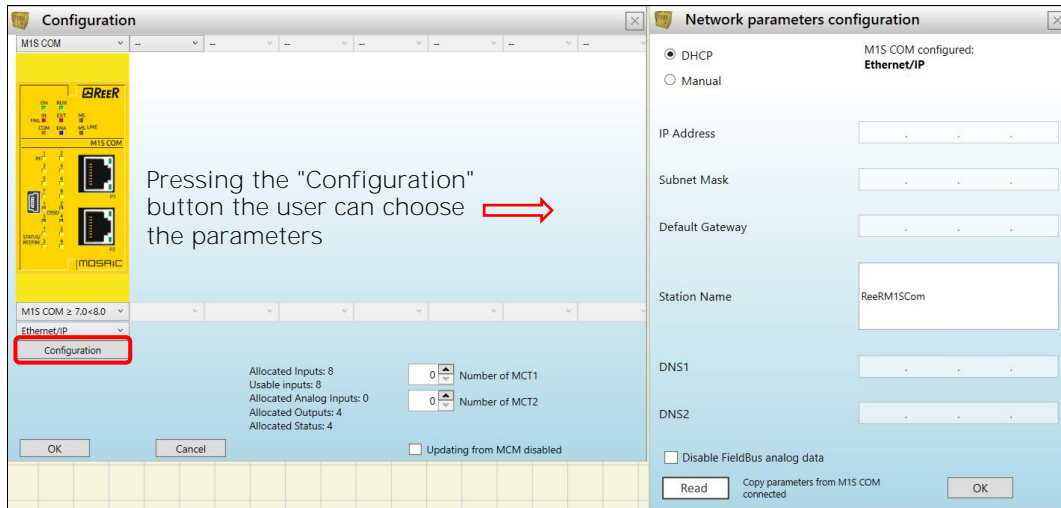

Figure 62

### Profinet RT parameters

When MOSAIC M1S COM has to be connected with Profinet RT fieldbus you must directly complete the necessary network parameters: IP Address, Subnet Mask, Default Gateway, Station Name.

- ➔ "Disable FieldBus analog data" will deactivate the transmission of MA2/MA4 analog data.
- ➔ Please note that the selection of this tick is a function of the process map (if "Disable FieldBus analog data" is selected, a process map without analog data must be used).
- ➔ Clicking on "Read" enables MSD to compile the network parameters by reading them from those set on the connected MOSAIC M1S COM master. The required parameters must be those of the currently loaded fieldbus. For example, if the connected module is ModBus TCP and you try to read the network parameters by setting Profinet RT as "Configuration" then reading will not be enabled.

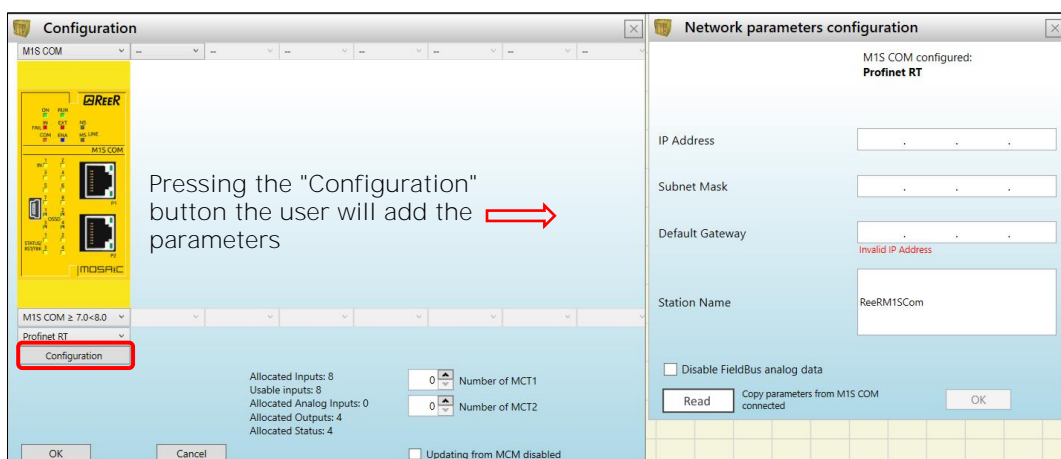

Figure 63

**EtherCat parameters**

When MOSAIC M1S COM has to be connected with EtherCat fieldbus the necessary network parameters will be set directly by the EtherCat Master.

- ➔ "Disable FieldBus analog data" will deactivate the transmission of MA2/MA4 analog data.
- ➔ Please note that the selection of this tick is a function of the process map (if "Disable FieldBus analog data" is selected, a process map without analog data must be used).
- ➔ Clicking on "Read" enables MSD to compile the network parameters by reading them from those set on the connected MOSAIC M1S COM master. The required parameters must be those of the currently loaded fieldbus. For example, if the connected module is ModBus TCP and you try to read the network parameters by setting Profinet RT as "Configuration" then reading will not be enabled.

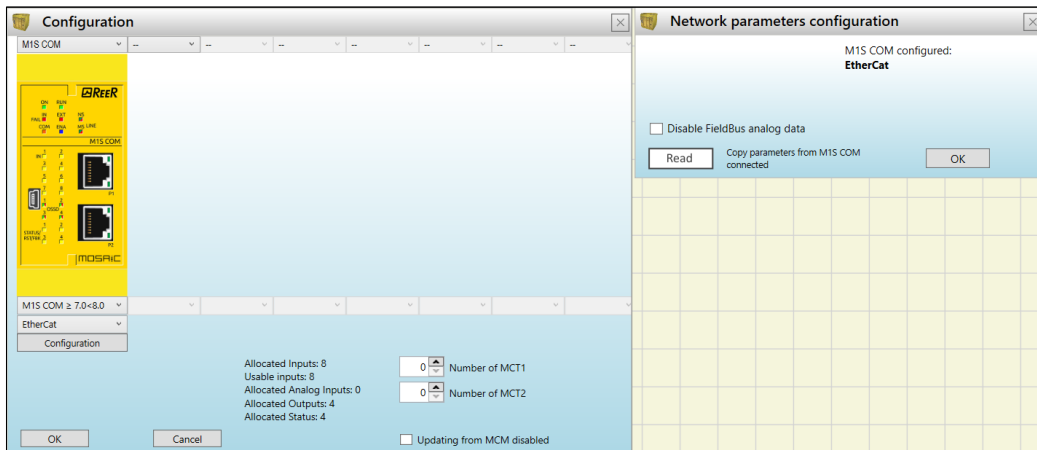



Figure 64

**Edit Configuration (composition of the various modules)**

The change of the system composition is obtained with the icon . The configuration window is showed again (Figure 56).

**Change user parameters**

The change of user parameters is obtained with the icon . The dialog user identification request appears (Figure 65). To accomplish this operation is not necessary to Log out from Mosaic. Generally it serves when the-user must create a new project (even using a previously created).

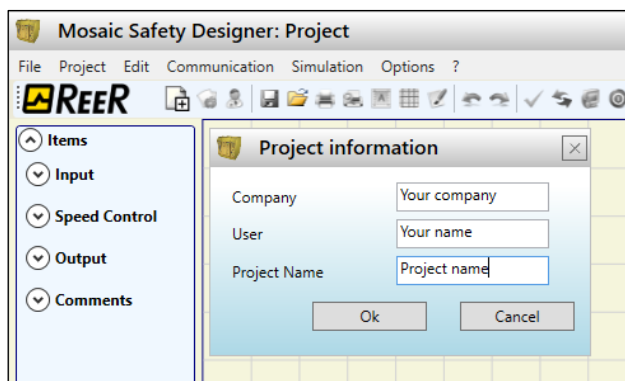

Figure 65

## Objects - Operator - Configuration toolbars

Four large tool windows are displayed to the left and right of the main window (shown in Figure 66):

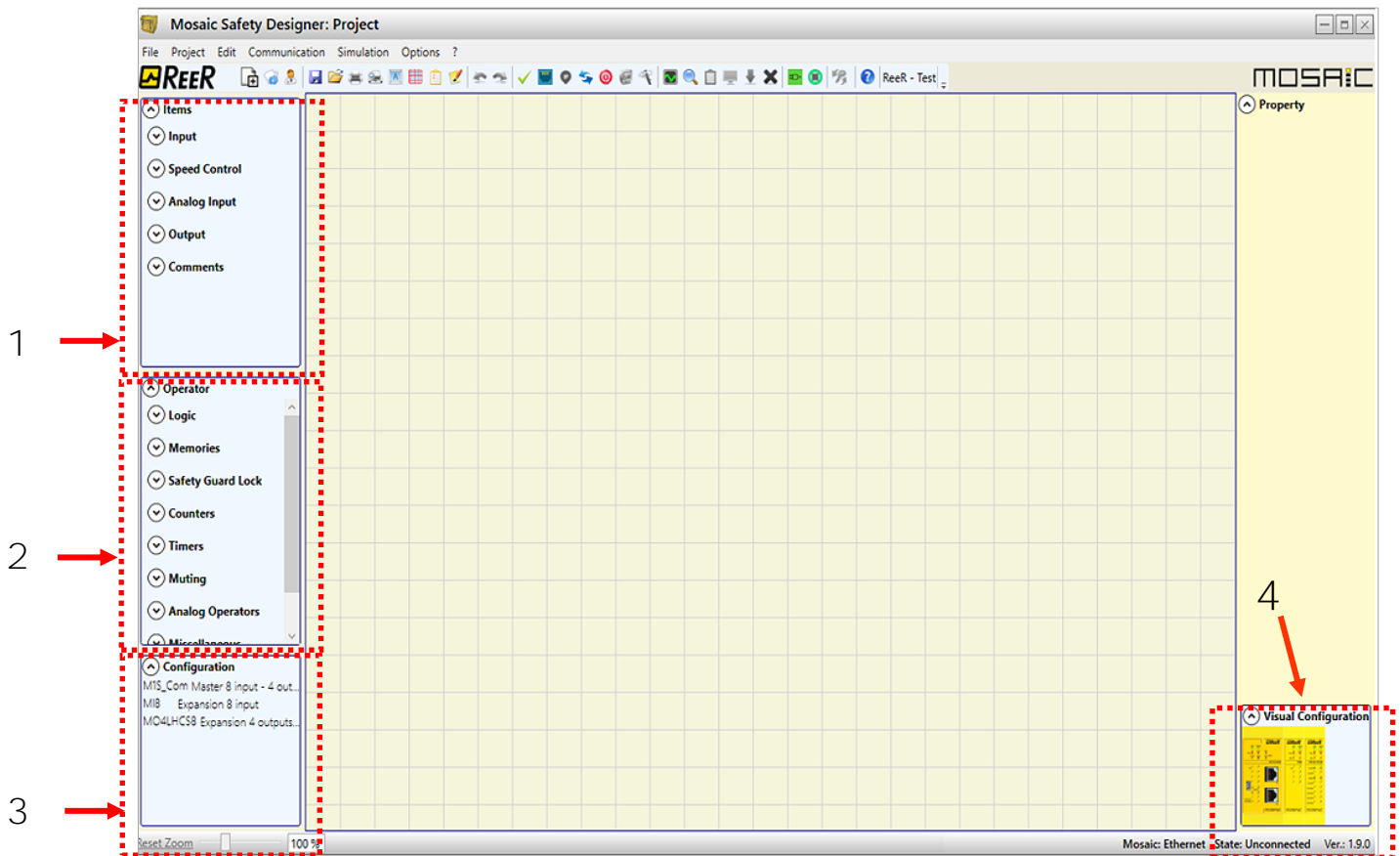

Figure 66

## 1 &gt; OBJECT TOOL WINDOW

This contains the various function blocks that will make up your project; these blocks are divided into five different types:

- Inputs
- Speed Monitoring
- Analog Input
- Outputs
- Comments

## 2 &gt; OPERATOR TOOL WINDOW

This contains the various function blocks for connecting the objects in point 1; these blocks are divided into 6 different types:

- Logic
- Memories
- Safety Guard Lock
- Counters
- Timers
- Muting
- Miscellaneous

## 3 &gt; CONFIGURATION TOOL WINDOW

This contains the description of your Mosaic composition.

## 4 &gt; CONFIGURATION TOOL WINDOW (view)

This contains the graphic representation of your Mosaic composition.

In this window it is possible to navigate through the I/Os of each module by acting with the right mouse button on the module to be analyzed.

Creating the diagram

Once you have selected your system composition, you are ready to configure the project. The logic diagram is created using a DRAG&DROP function:

- Select the objects as required from the windows described previously (each single object is described in detail in the following sections) and drag it into the design area.
- Now when you select the object the PROPERTIES window is enabled, where you must fill in the fields as required.
- When you need to set a specific numerical value with a slide (eg filter) use the left and right arrows on your keyboard or click the sides of the slider.
- Connect the objects by moving the mouse over the required pin and then dragging it onto the pin to be connected.
- If the scheme requires the PAN function (moving working area in the window), select the object to move and use the arrow keys on your keyboard.
- If the scheme is very complicated and requires a connection between two elements very far, use the "Interpage" component. The element **"Interpage out"** must have a name which, invoked by the corresponding **"Interpage in"**, allows the desired link.

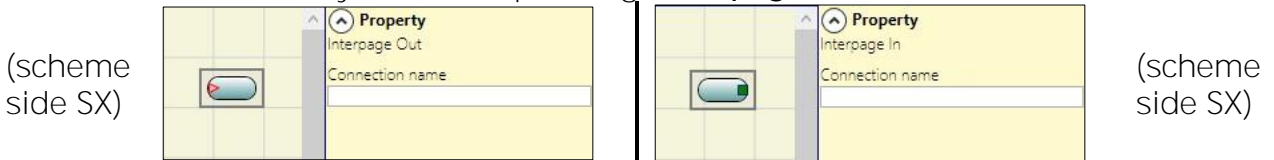

- When you need to duplicate an object, select it and press CTRL+C / CTRL+V keys on your keyboard or click at the right mouse button and select context menu "Copy" and then "Paste".
- Wires position: it is possible to move the wires for a better graphic visibility of the scheme. To activate the function, simply place the mouse pointer and left click on the wire to be moved.

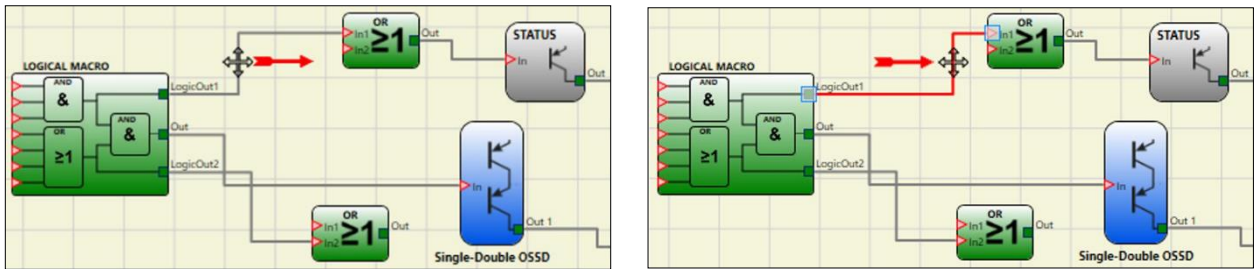

- When you need to delete an object or a link, select it and press DEL key on your keyboard.
- Find function: (press CTRL + F) allows you to make search within the scheme based on a search parameter. Research does not distinguish between upper and lower case.

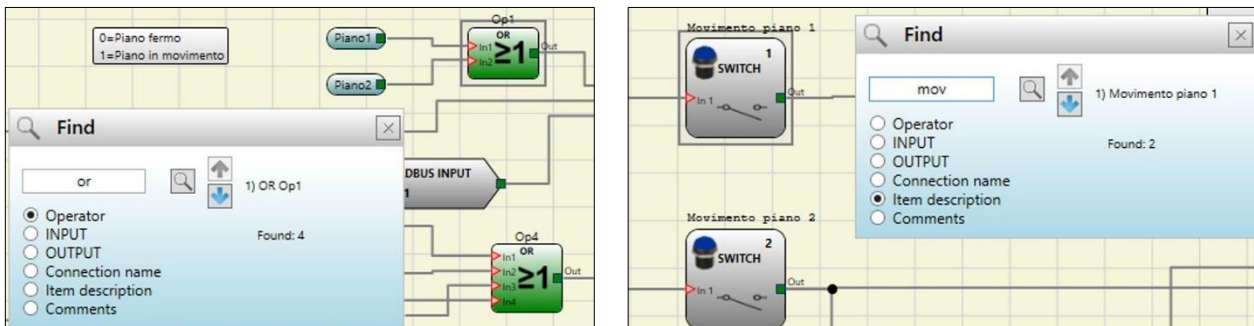

Find Operator

Find item description

Use of mouse right button

**Block Input / Output**

- Copy / Paste
- Delete
- Delete all the assigned pins
- Alignment with other functional blocks (multiple selection)
- On-line Help
- Monitor Mode: Show / Hide Properties window
- The block Status: pin input enable / disable logical negation

**Block Operators**

- Copy / Paste
- Delete
- Alignment with other functional blocks (multiple selection)
- On-line Help
- On input pin: activate / deactivate logical negation
- Monitor Mode: Show / Hide Properties window

**Terminals**

- Alignment with other blocks

**Connection (Wires)**

- Delete
- Display full path of the connection (network)

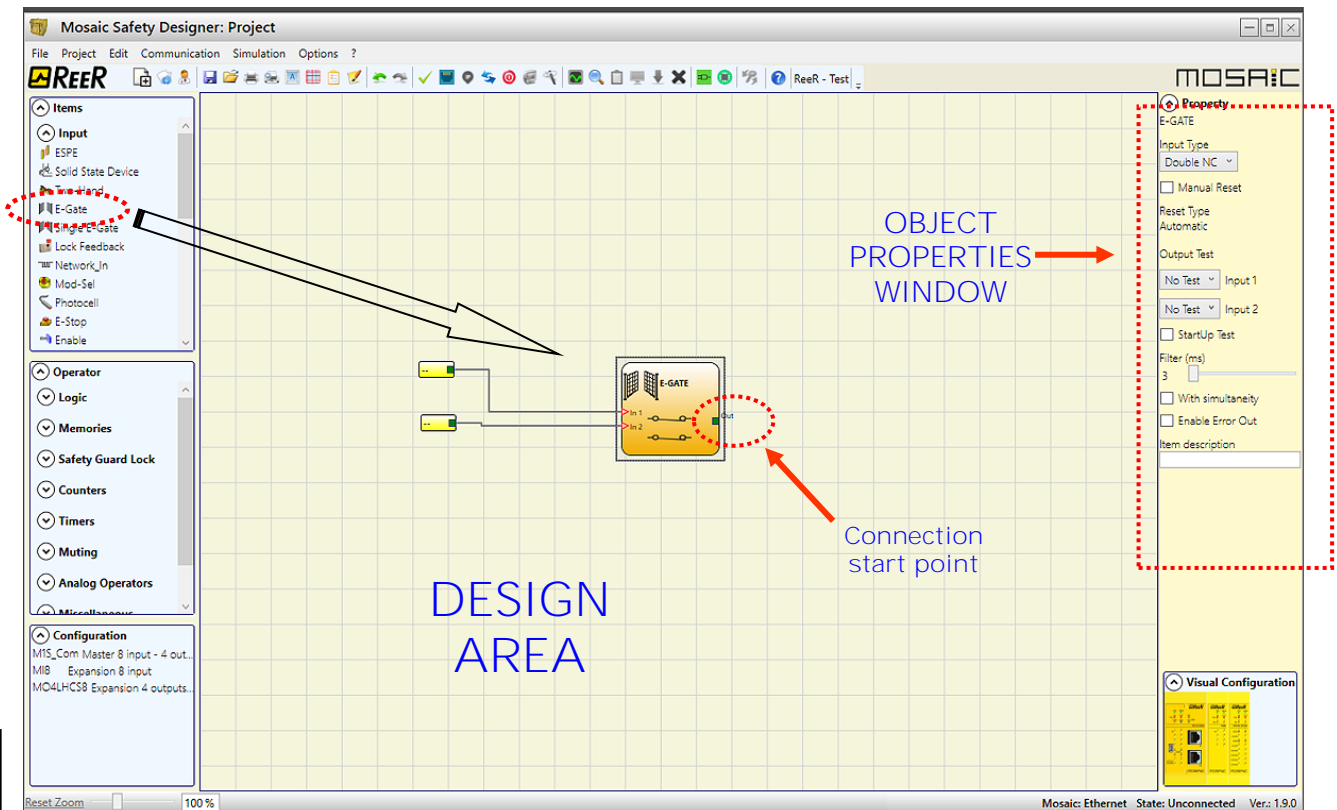

Figure 67

Example of a project

Figure 68 shows an example of a project in which the MOSAIC M1S unit only is connected to two safety blocks (E-GATE and E-STOP).

The MOSAIC M1S inputs (1,2,3) for connecting the contacts of the safety components are shown on the left, in yellow. The MOSAIC outputs (from 1 to 2) are activated according to the conditions defined in E-GATE and E-STOP (see the **E-GATE - E-STOP** sections).

By clicking on a block to select it, you enable the PROPERTIES WINDOW on the right, which you can use to configure the block activation and test parameters (see the **E-GATE - E-STOP** sections).

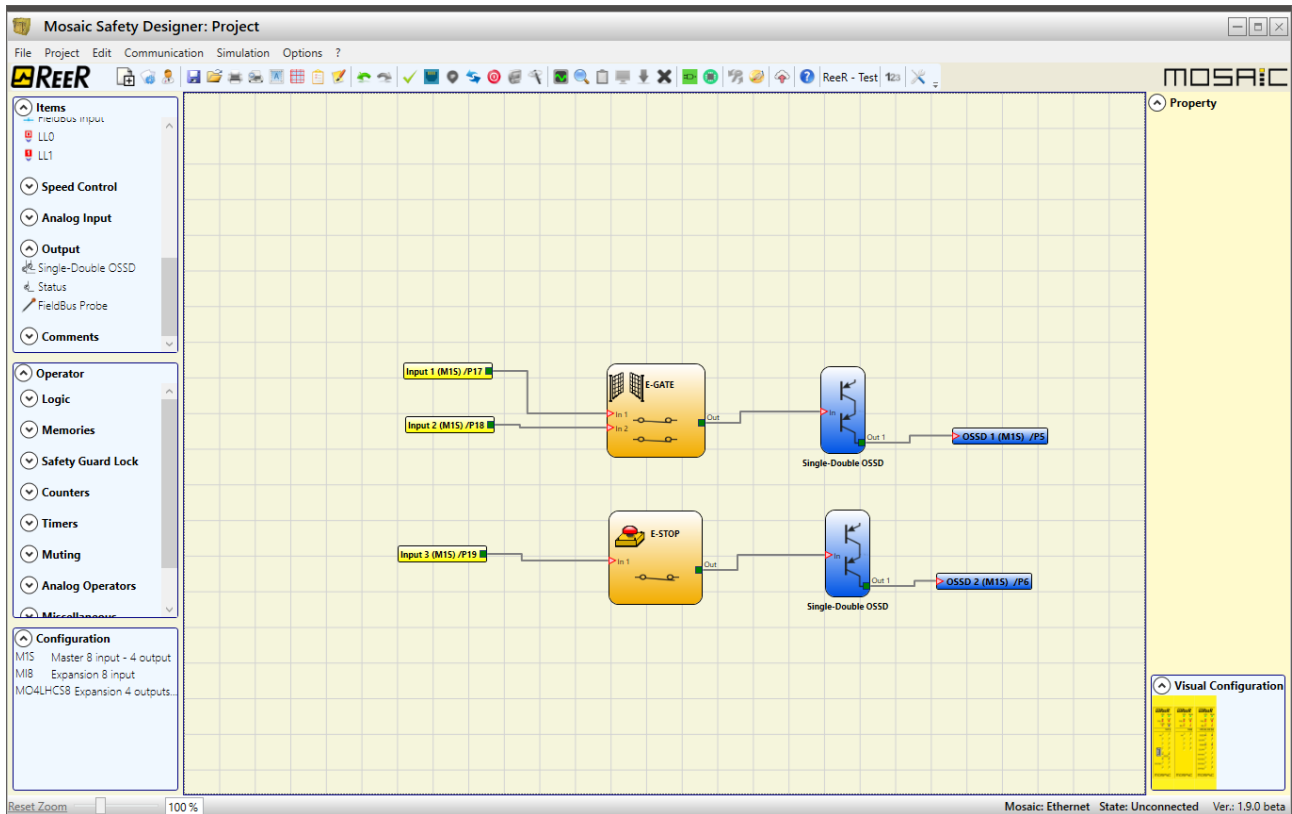

Figure 68

At the end of the project design stage (or at intermediate steps) you can save the current configuration using the icon SAVE on the standard tool bar.

Project validation

➔ Now the finished project must be verified. Execute the VALIDATE command (Icon on the standard toolbar).

If the validation is successful, a sequential number is assigned to the input and output of the project. Then, this number is also listed in the REPORT and in the MONITOR of MSD. Only if the validation is successful we will proceed to send the configuration.

The validation function only verifies the consistency of programming with respect to the characteristics of the MOSAIC system. It does not guarantee that the device has been programmed to meet all the safety requirements for the application.

Resources Allocation

To activate the RESOURCES ALLOCATION function use the icon .

Executing this command, all the used elements among Inputs, Outputs, Status, Fieldbus input and Probe are visible, see the example in figure.

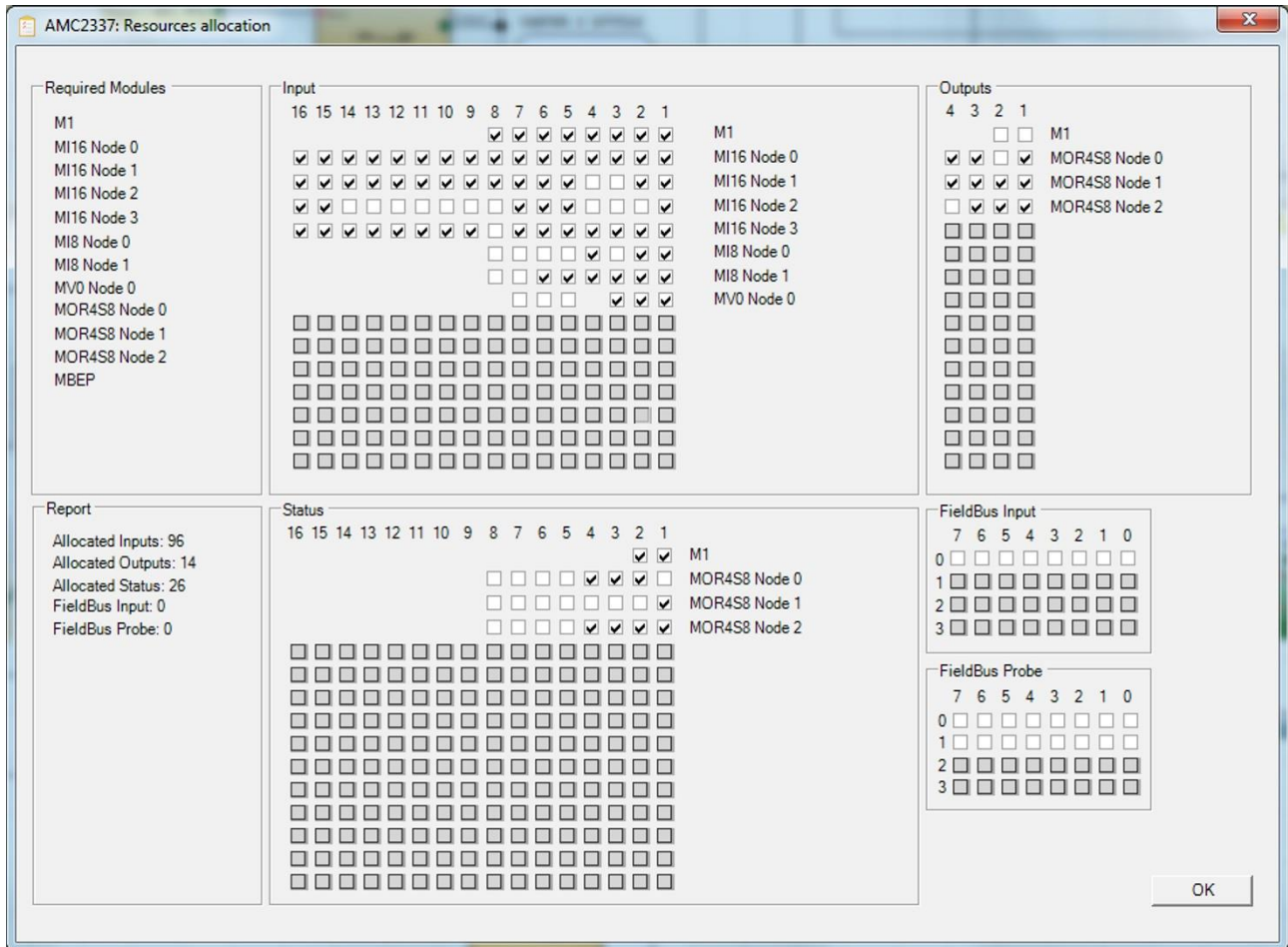



Figure 69



Project report

Print of the System composition with properties of each block. (Icon  on the standard toolbar).



**MOSAIC**  
MODular SAFETY Integrated Controller



**REER**  
Via Carcano, 32  
10153 Torino Italia  
<http://www.reer.it>

Project Report generated by Mosaic Safety Designer Ver.: 1.6.1.2

Project Name: Projekt  
 User: Name  
 Company: Azienda  
 Date: 18/12/2018 18:10:54  
 Schematic CRC: D909H Schematic CRC

Mosaic: Configuration  
 Module M1S (Configured Firmware version: FW >= 5.0)  
 Module MI16 Node 2 (Minimum Required Firmware version: 0.1)  
 Module MI804 Node 0 (Minimum Required Firmware version: 0.0)  
 Updating from MCM Disabled: False  
 Cycle Time (ms) = 3,951 Cycle time

Mosaic: Safety Information  
 PFHd (according to IEC 61508): 3,15E-008 (1/h)  
 MTTFd (according to EN ISO 13849-1): 68 years Safety level information  
 DCavg (according to EN ISO 13849-1): 99.00 %

**Attention!**  
 This definition of PL and of the other related parameters as set forth in EN ISO 13849-1 only refers to the functions implemented in the Mosaic system by the MSD configuration software, assuming configuration has been performed correctly. The actual PL of the entire application and the relative parameters must consider data for all the devices connected to the Mosaic system within the scope of the application. This task and any other aspect of system configuration are the exclusive responsibility of the user/installer.

The final MTTFd value, taking in account data for all the devices connected to the system, must always be saturated to 100 years if over.

**Resources used** Used resources

**Attention!**  
 Input3 (M1S) E-Stop: Error enabled, but no Output Test configured  
 Input4 (M1S) Enable: Error enabled, but no Output Test configured

INPUT: 16% (5/32)  
 Function Blocks: 3  
 Total number blocks: 1% (1/128)  
 OSSD: 38% (3/8)  
 STATUS: 25% (2/8)

**Electrical diagram**

**E-Gate**  
 Function Block 1  
 Filter (ms): 3  
 Double NC  
 Reset Type: Automatic  
 StartUp Test: False  
 Connections:  
 In1: M1S INPUT1/Terminal17  
 In2: M1S INPUT2/Terminal18

**E-Stop**  
 Function Block 2  
 Filter (ms): 3  
 Single  
 Reset Type: Automatic  
 StartUp Test: False  
 Connections:  
 In1: M1S INPUT3/Terminal19

**Enable**  
 Function Block 3  
 Filter (ms): 3  
 Single  
 Reset Type: Monitored  
 StartUp Test: True  
 Connections:

Page 1 of 2

Figure 70

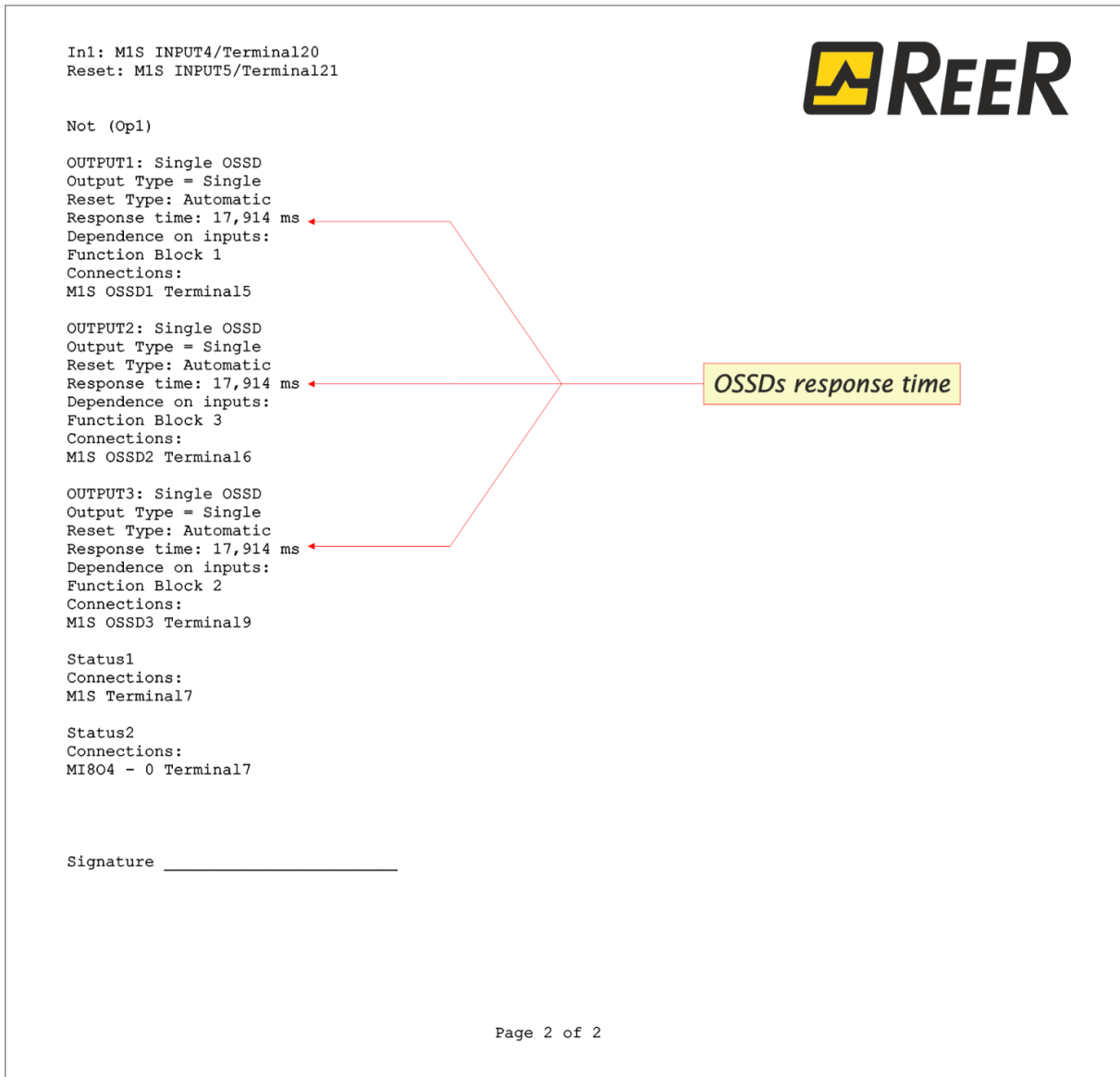

Figure 71

- ⚠ This definition of PL and of the other related parameters as set forth in ISO 13849-1 only refers to the functions implemented in the Mosaic system by the MSD configuration software, assuming configuration has been performed correctly.
- ⚠ The actual PL of the entire application and the relative parameters must consider data for all the devices connected to the Mosaic system within the scope of the application.
- ⚠ This must only be performed by the user/installer.

## Connect MSD to Mosaic Master

### Communication channel selection

The icon allow user to choose which type of connection activate with MSD: USB or LAN.

A pop-up window will appear on MSD with 2 parameters to be set.

#### **USB connection**

Selecting "USB" the master can be connected to the PC with a USB cable.

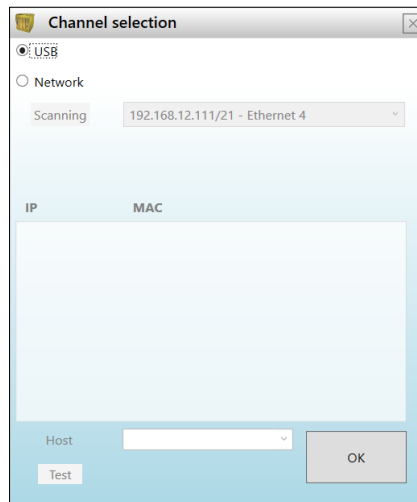

Figure 72

#### **Network Connection (MOSAIC M1S COM only)**

Selecting "Network" MOSAIC M1S COM can be connected to the PC via LAN.

The user has to choose the Network Interface of PC and the MOSAIC M1S COM (Host) IP Address.

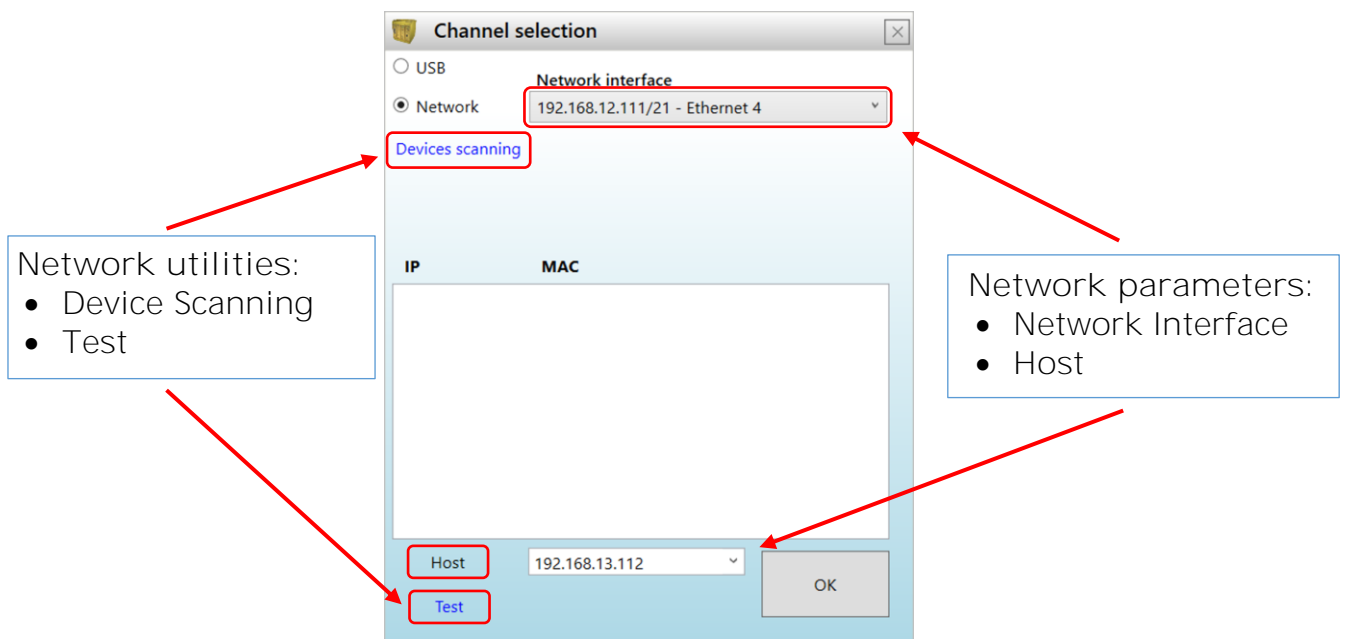

Figure 73 - Channel Selection

HOST: Type in this field the IP address of the MOSAIC M1S COM module to be connected.

➔ **HOST**: MSD will show the last 10 IP addresses entered by the user.

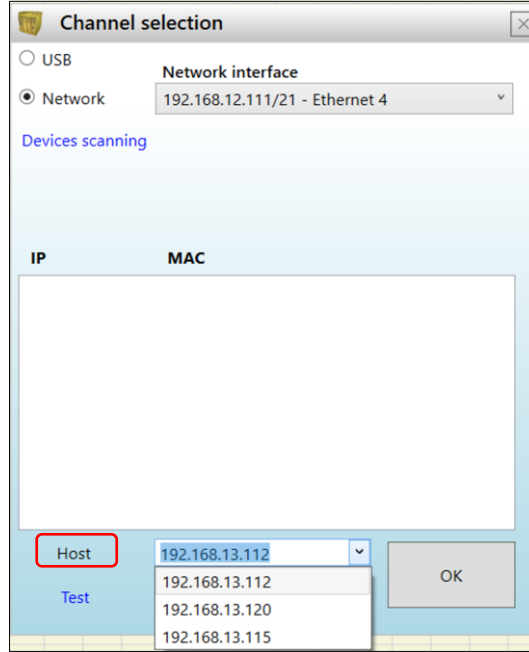

Figure 74 - Host selection

DEVICE SCANNING: By clicking on the word "Device Scanning" MSD will start searching for MOSAIC M1S COM devices in the Local Area Network. If devices are found then a list is displayed in the text box. It is shown each device IP together with its MAC address.

The IP address of the PC where MSD is running is displayed near the word Network.

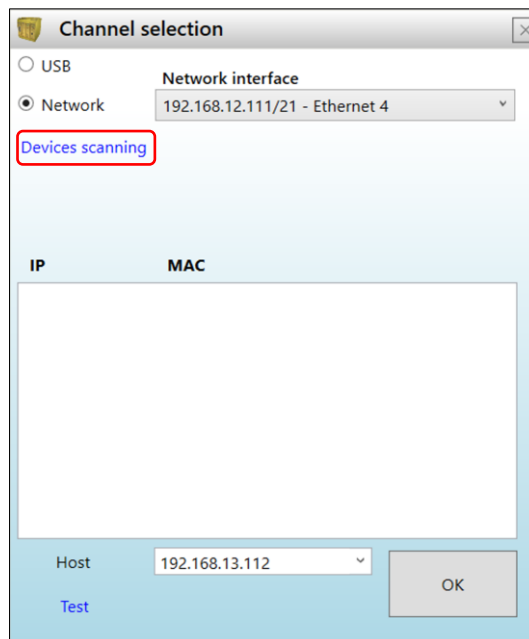

Figure 75 - Device scanning

➔ The following figure shows the scanning phase in progress and the detection of devices with their IP and MAC addresses.

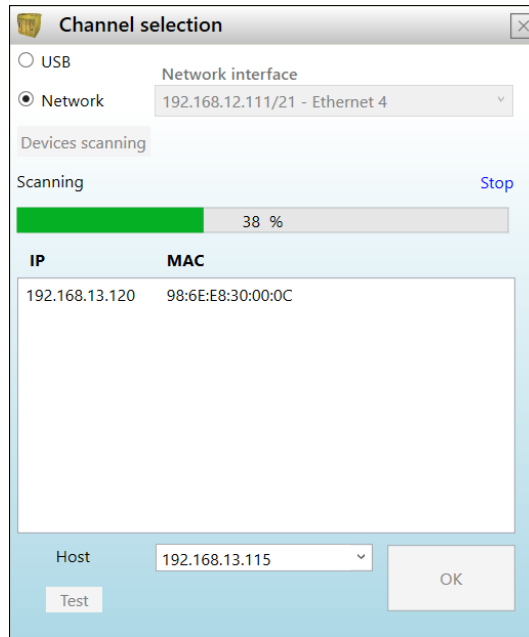

Figure 76 - Scanning phase

TEST: Clicking on the word "Test" the presence of the host (MOSAIC M1S COM) on the network is verified.

➔ In the following figure is showed a "Test performed succesfully" message.

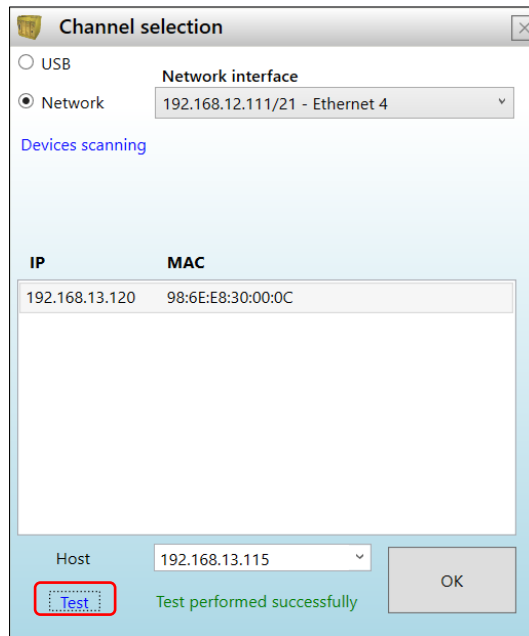

Figure 77 - Test performed succesfully

➔ In the following figure is showed a "Test failed" message.

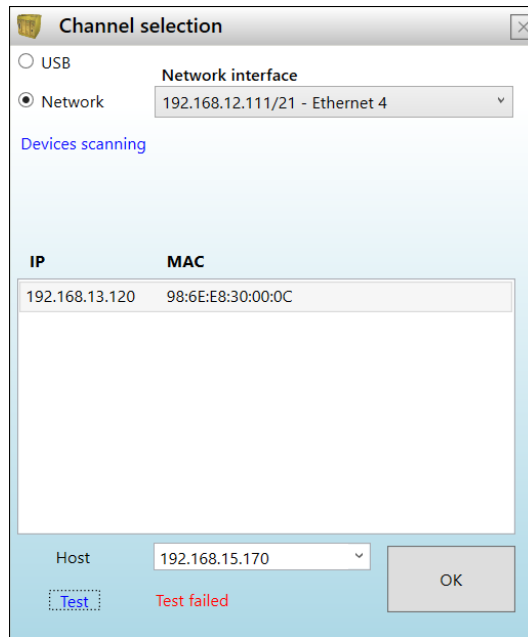



Figure 78 - Test failed

➔ After clicking on  icon MSD start the connection with MOSAIC M1/MOSAIC M1S module (only through USB) or with MOSAIC M1S COM (through USB or LAN).

A window appears to request the password. Enter the password (see "Password protection").

➔ With the eye "visible/not visible" icon you can select to see/hide the entered password.



Figure 79 - USB

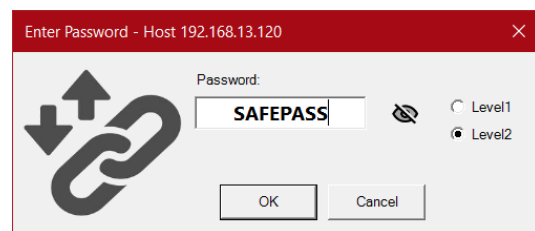



Figure 80 - LAN

Connected Master parameters visualization

*MOSAIC M1S COM connected via LAN*

- ➔ When MOSAIC M1S COM is connected via LAN in the “Module connected” textbox are displayed these parameters:
- ➔ MOSAIC M1S COM: firmware version
- ➔ Ethernet Release: current ZIP container stored
- ➔ IP: MOSAIC M1S COM IP address
- ➔ MAC: MOSAIC M1S COM MAC address
- ➔ Protocol choice: the currently running Fieldbus together with its version.
- ➔ S/N: module serial number
- ➔ The  symbol showed into the bottom status bar indicates that the current LAN communication session is encrypted with AES128.

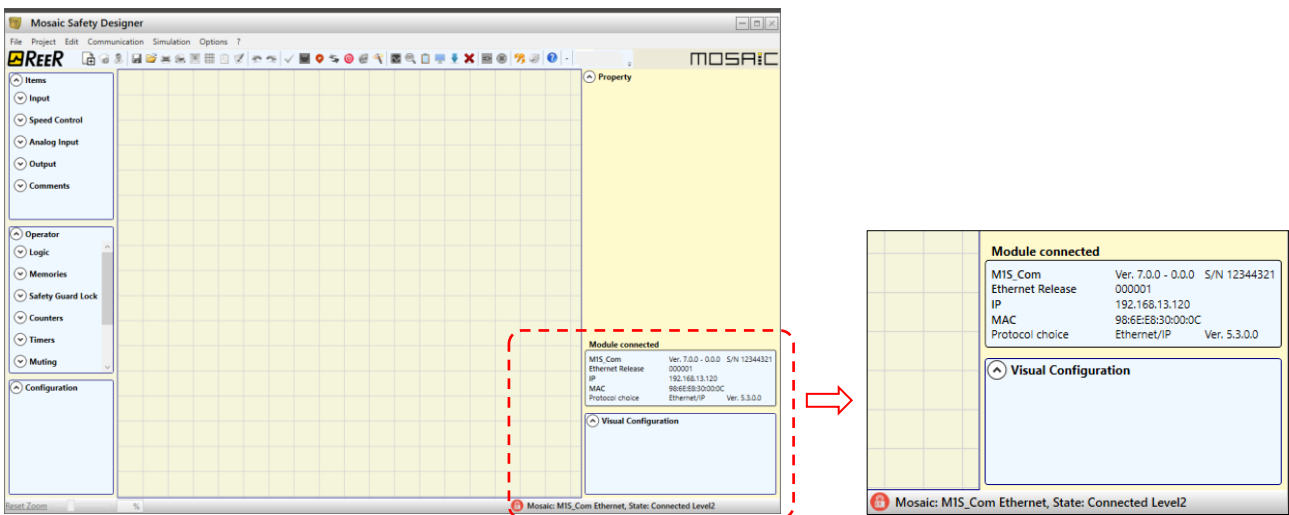

Figure 81

*MOSAIC M1S COM connected via USB*

- ➔ When MOSAIC M1S COM is connected via LAN in the “Module connected” textbox are displayed these parameters:
- ➔ MOSAIC M1S COM: firmware version
- ➔ Ethernet Release: current ZIP container stored
- ➔ MAC: MOSAIC M1S COM MAC address
- ➔ Protocol choice: the currently running Fieldbus together with its version.
- ➔ S/N: module serial number

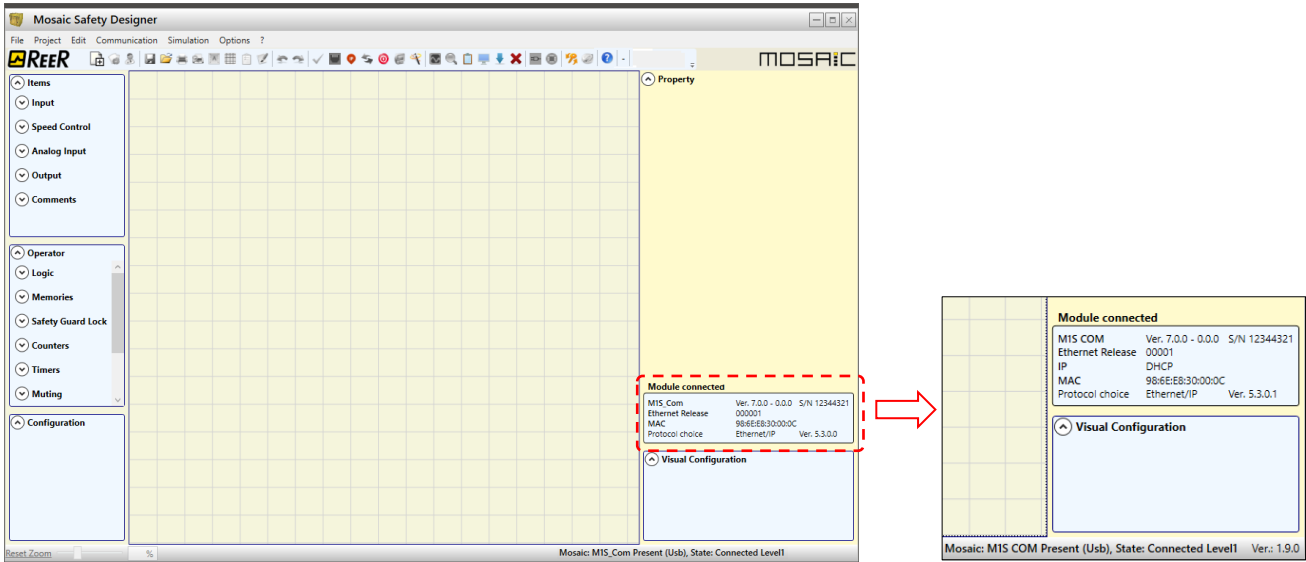

Figure 82

MOSAIC M1/MOSAIC M1S connected via USB

➔ When MOSAIC M1/MOSAIC M1S COM is connected via USB in the “Module connected” textbox are displayed these parameters:

- MOSAIC M1/MOSAIC M1S: firmware version
- S/N: module serial number

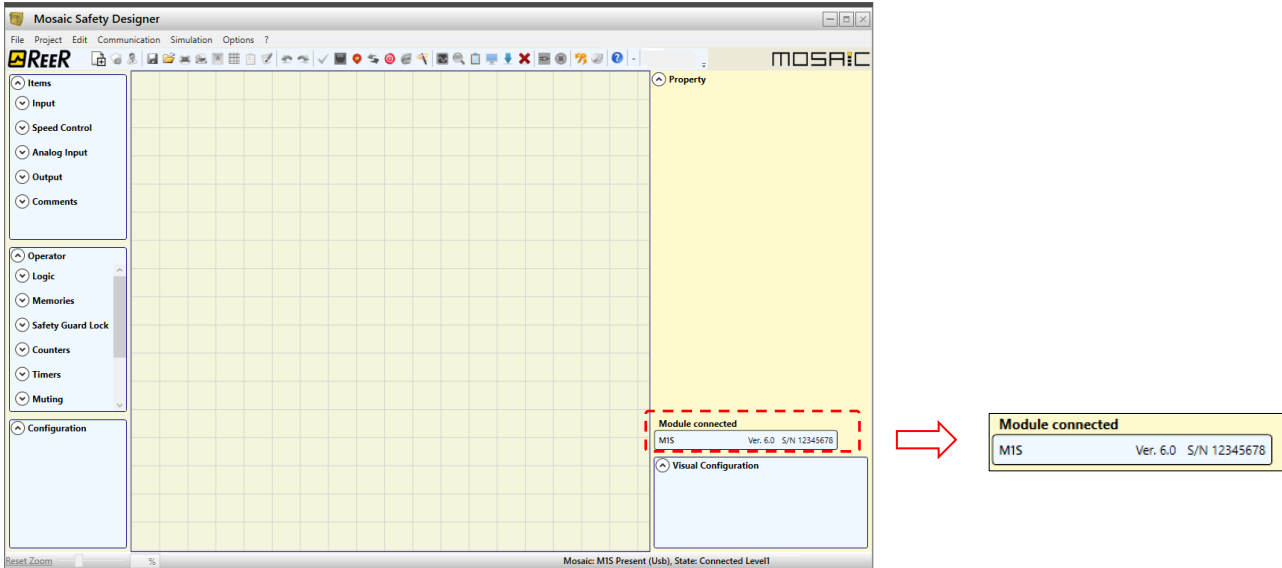

Figure 83



Operations available with master connected (MOSAIC M1S COM)

**Visualization network parameters**

With the Level 1 password, the user is only allowed to view the connection parameters (refer to Password protection).

Select the icon to read the Fieldbus parameters.

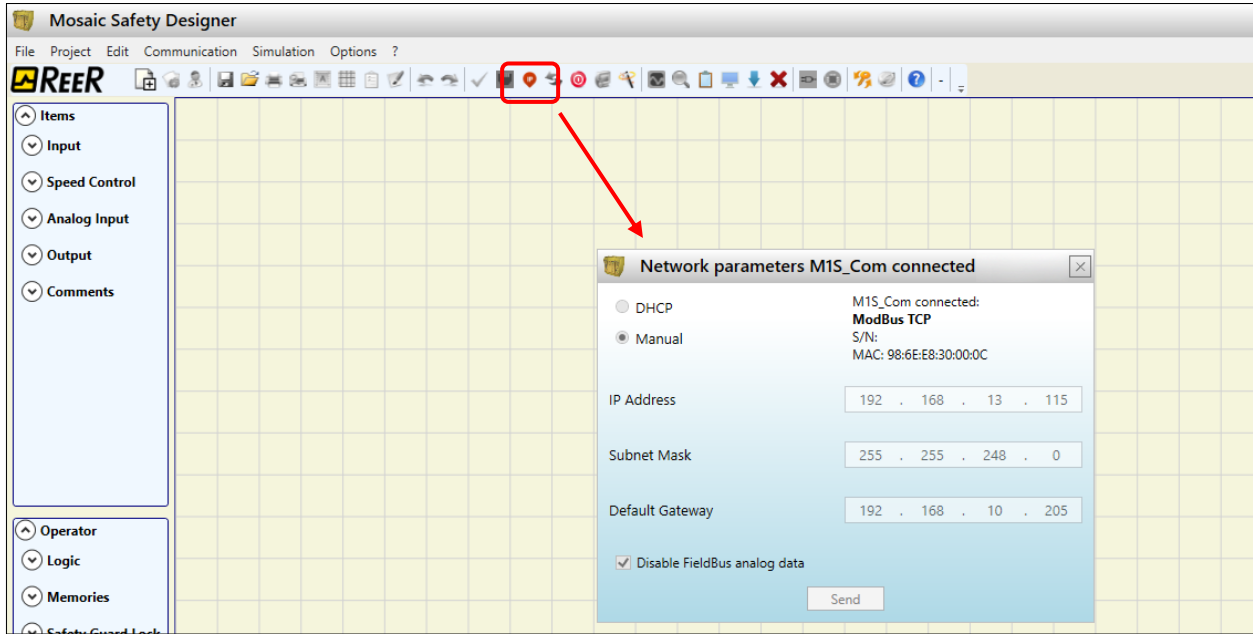

Figure 84

**Visualization/setting network parameters (MOSAIC M1S COM)**

With the Level 2 password, the user is enabled to view and edit the connection parameters (refer to Password protection).

Select the icon to modify/send the Fieldbus parameters.

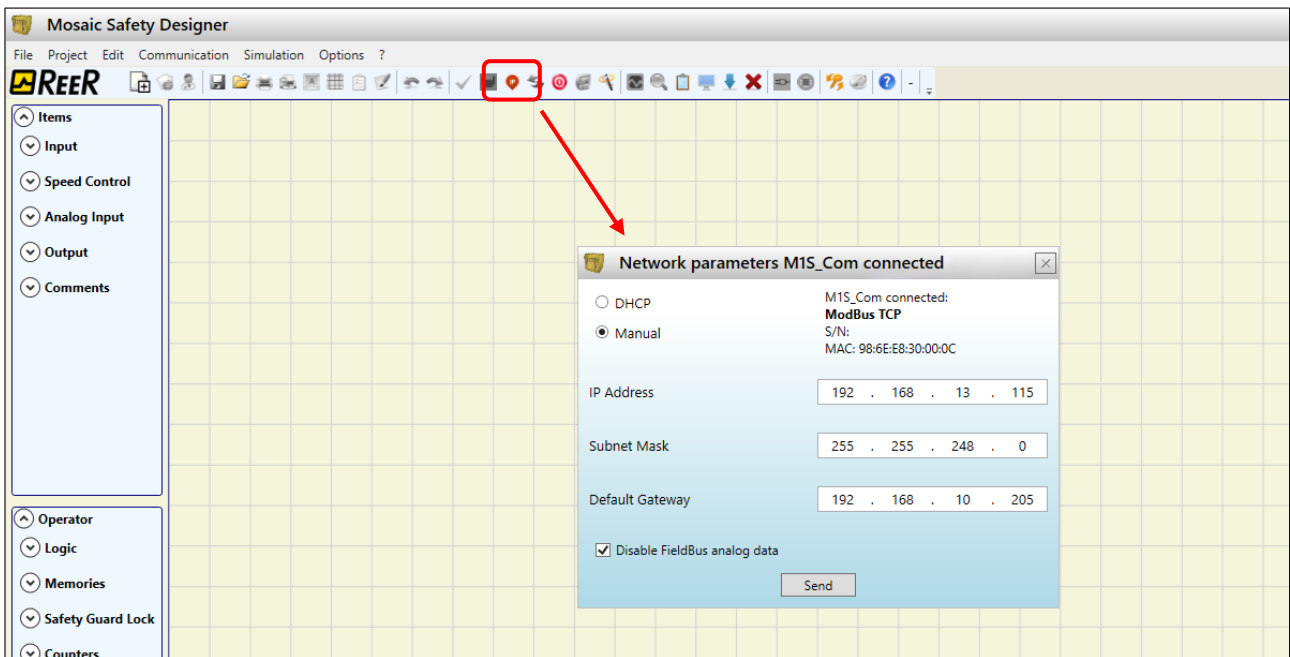



Figure 85

- ➔ "Disable FieldBus analog data" will deactivate the transmission of MA2/MA4 analog data.
- ➔ Please note that the selection of this tick is a function of the process map (if "Disable FieldBus analog data" is selected, a process map without analog data must be used).

**Download project to MOSAIC (from PC)**

To send the saved configuration from a PC to MOSAIC M1, MOSAIC M1S, MOSAIC M1S COM use the icon  on the standard toolbar and wait the execution. MOSAIC M1, MOSAIC M1S, MOSAIC M1S COM will save the project in its internal memory and (if present) in MCM memory. (Password Required: level 2).

- ➔ This function is possible only after project validation with OK result.

- ➔ After the initial MSD configuration you must confirm the choice pressing "YES", the system will ask you to confirm.
- ➔ MOSAIC M1S COM only: you can also send the network parameters to Mosaic by selecting the tick in "Figure 87 - MOSAIC M1S COM".

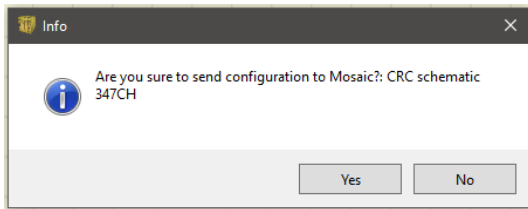

Figure 86 - MOSAIC M1/MOSAIC M1S

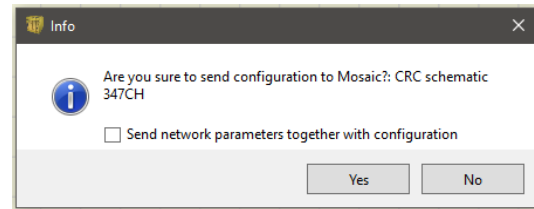



Figure 87 - MOSAIC M1S COM

- ➔ MOSAIC M1S COM only: when in a project the user changes the Fieldbus type (e.g.: from Modbus/TCP to EtherNet/IP) after the  pression (to send the new configuration) a pop-up warning is shown. The new Fieldbus will be available after the new schematic is sent and a system restart is performed.

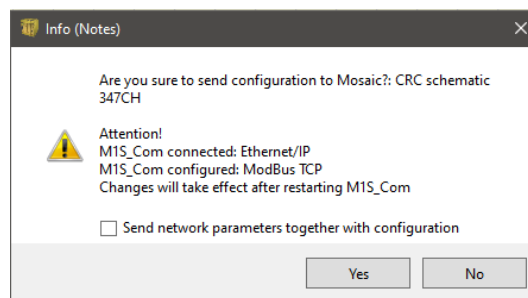

Figure 88 - MOSAIC M1S COM FieldBus change

**Upload an existing project to PC (from MOSAIC)**

To upload a project from MOSAIC M1, MOSAIC M1S, MOSAIC M1S COM to MSD use the icon on the Standard toolbar. MSD will display the project residing in MOSAIC M1, MOSAIC M1S, MOSAIC M1S COM. (Level 1 password is enough).

- ➔ If the project must be used on other mosaic system verify the modules effectively connected (ref. "**System composition**" on page 123).
- ➔ Then perform a "**Project Validation**" (page 111) and a "**Testing the System**" (page 127).
- ➔ In this phase, MSD (version 1.9.0 and higher) reads the original msx file contained in MOSAIC M1S, MOSAIC M1S COM, with the blocks, comments, etc. (as drawn by the designer).

**Configurations LOG**

- ➔ Within the configuration file (project), are included the **creation date** and **CRC (4-digit hexadecimal identification)** of a project that are stored in MOSAIC M1, MOSAIC M1S, MOSAIC M1S COM.
- ➔ If MOSAIC M1S, MOSAIC M1S COM is used, it is also indicated whether the schematic was loaded via MSD or via MCM memory
- ➔ This logbook can record up to 5 consecutive events, after which these are overwritten, starting from the least recent event.

The log file can be visualized using the icon in the standard tool bar. (Password Required: level 1).

Date	CRC	Source
07/02/2018	BBB6H	Mosaic Safety Designer
07/02/2018	EFCC	Mosaic Safety Designer
06/28/2018	CB37H	Mosaic Safety Designer
06/28/2018	52BCH	Mosaic Safety Designer
06/22/2018	D6D5H	Mosaic Safety Designer

Figure 89

**System composition**

The check of the actual composition of the MOSAIC system is obtained using the icon . (Password Required: level 1). A pop-up window will appear with:

- Connected modules;
- Firmware version of each module;
- Node number (physical address) of each module.

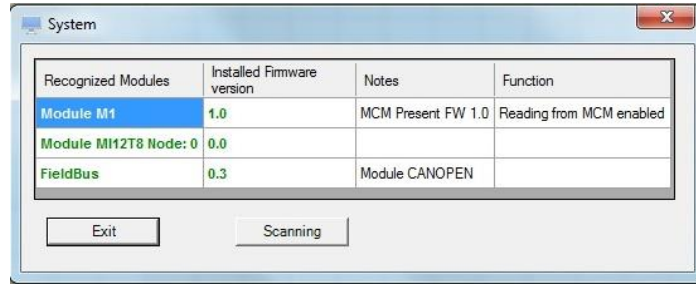

Figure 90

If the modules found are not correct the following window will appear; e.g. MI12T8 node number not correct (displayed in red color text).

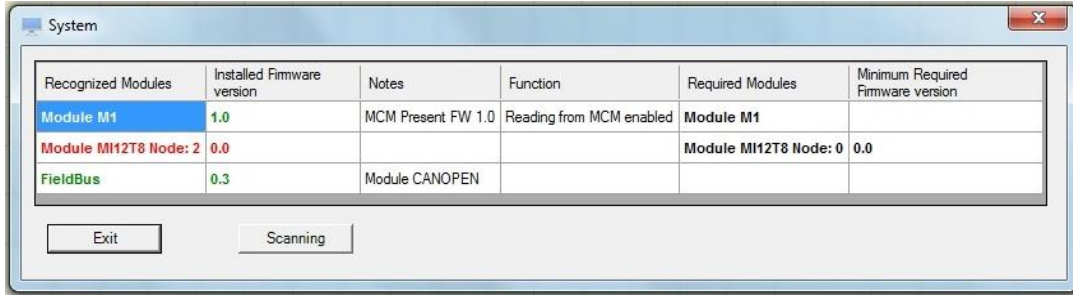

Figure 91

Errors Log

The errors log can be visualized using the icon in the standard tool bar. (Password Required: level 1).

The errors log can be deleted from Mosaic using the icon in the standard tool bar. (Password Required: level 1).

➔ Please refer to the paragraph "Errors Log at page 254.

Disconnecting System

To disconnect the PC from MOSAIC M1, MOSAIC M1S, MOSAIC M1S COM use the icon ; when the system is disconnected it is resetted and it starts with the sent project.

➔ If the system is not composed of all modules provided by the configuration, after the disconnection MOSAIC M1, MOSAIC M1S, MOSAIC M1S COM indicates the incongruity and does not starts. (See SIGNALS).

Monitor functions

Monitor (I/O status in real time - textual)

To activate the MONITOR function use the icon . (Password Required: level 1). A pop-up window will appear with (all in real time):

- input's state (when the object has two or more input connections to Mosaic, the MONITOR will show as active only the first), see the example in figure;
- Input's/Out\_test Diagnostics;
- OSSD's State;

english

- OSSD's Diagnostics;
- Signaling OUTPUT's state;

Module	block	Notes	INPUT	State	Input diagnostic	Module	OSSD	State	OSSD diagnostic	Module	Status	State	Diag Status
M1S	1	Enable	IN1	OFF		M1S	OSSD1	OFF			X		
M1S	2	Enable	IN2	OFF		M1S	OSSD2	OFF			X		
M1S	3	Enable	IN3	OFF		M1S	OSSD3	OFF			X		
M1S	4	Enable	IN4	OFF		M1S	OSSD4	OFF			X		
M1S	5	Enable	IN5	OFF		MI804-0	OSSD5	OFF			X		
M1S	6	Enable	IN6	OFF		MI804-0	OSSD6	OFF			X		
M1S	7	Enable	IN7	OFF		MI804-0	OSSD7	OFF			X		
M1S	8	Enable	IN8	OFF		MI804-0	OSSD8	OFF			X		
			X										
			X										
			X										
			X										
			X										
			X										
			X										
			X										

Exit

Figure 92 - textual monitor

**Monitor (I/O status in real time - textual - graphic)**

To activate/deactivate the monitor use the icon . (Password Required: level 1).  
 The color of links (Figure 33) allows you to view the diagnostics (in real time) with:  
 RED = OFF  
 GREEN = ON  
 DASHED ORANGE = Connection Error  
 DASHED RED = Pending enable (for example RESTART)

➔ Placing the mouse pointer over the link, you can display the diagnostics.

**Particular Cases**

- ➔ NETWORK OPERATOR, signals NETWORK IN, OUT:  
**RED CONTINUOUS LINE = STOP**  
**GREEN CONTINUOUS LINE = RUN**  
**ORANGE CONTINUOUS LINE = START**
- ➔ SERIAL OUTPUT OPERATOR:  
**BLACK CONTINUOUS LINE = data in transmission**

The schematic can't be changed during the monitor. It is possible to display the parameters of a component by clicking on it with the right mouse button, choosing "Show/Hide Properties".

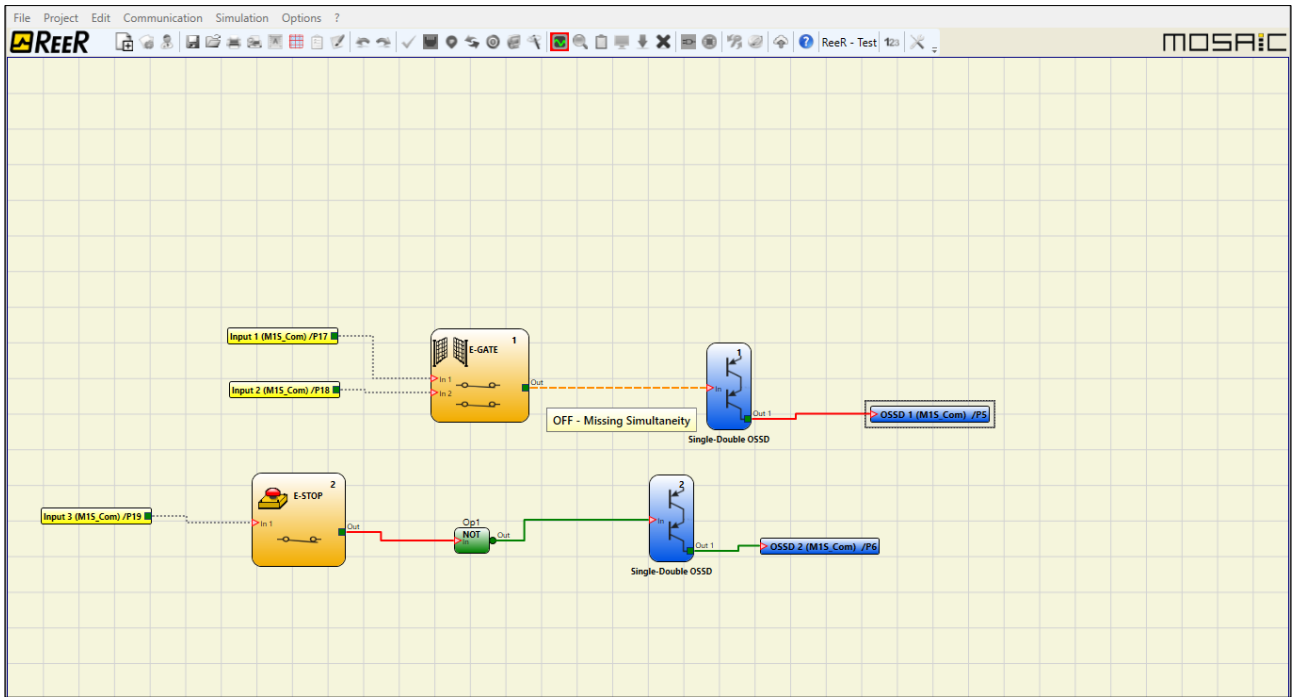



Figure 93 - graphical monitor

➔ MOSAIC M1S COM: if the Monitor is performed with LAN connection the  symbol showed into the bottom status bar indicates that the current communication session is encrypted with AES128.

Password protection

The MSD requests a password in order to upload and save the project.

➔ The password entered as default must be modified to avoid manipulation (level 2 password) or so that the configuration loaded on Mosaic (level 1 password) is not visible.

Level 1 password

All operators using the MOSAIC M1, MOSAIC M1S, MOSAIC M1S COM system must have a Level 1 PASSWORD.

This password allows only to view the configuration and error LOGs, composition of the system and MONITOR in real time and upload operations.

For the first time the password is "" (ENTER key).

Designers who know the level 2 password can enter a new level 1 password (alphanumeric, max 8 characters).

➔ Operators who know this password **are enabled** to upload (from MOSAIC M1, MOSAIC M1S, MOSAIC M1S COM to PC), modify or save the project.

Level 2 password

Designers authorised to work on the creation of the project must know a Level 2 PASSWORD. The first time the system is initialised the operator must use the password "SAFEPASS" (all capital letters).

Designers who know the level 2 password can enter a new level 2 password (alphanumeric, max 8 characters).

With the Level 2 password, the designers authorized has available all the functions of Level 1 plus the ability to download the project from PC to Mosaic and change the passwords

- ➔ This password **enables** the project to be uploaded (from PC to Master), modified and saved. In other words, it allows total control of the PC => MOSAIC system.
- ➔ When a new project is UPLOADED the level 2 password could be changed.
- ➔ Should you forget either of these passwords, please contact Reer which will provide an unlock file (when the unlock file is saved in the right directory the icon  will appear on the toolbar). When the icon is activated, the password level 1 and level 2 are restored to their original values. This password is only given to the designer and can only be used once.

**Password Change**

To activate the PASSWORD Change use icon , after connecting with Level 2 Password. A window appears (Figure 94) allowing the choice of the new password; insert the old and new passwords in the appropriate fields (max 8 characters). Click OK. At the end of the operation disconnect to restart the system. If MCM is present the new password is also saved in it.



Figure 94

**Testing the system**

- ⚡ After validating and uploading the project to the MOSAIC M1, MOSAIC M1S, MOSAIC M1S COM and connecting all the safety devices, you must test the system to verify its correct operation.

This is done by forcing a change of status for each safety device connected to the MOSAIC to check that the status of the outputs actually changes. The following example is helpful for understanding the TEST procedure.

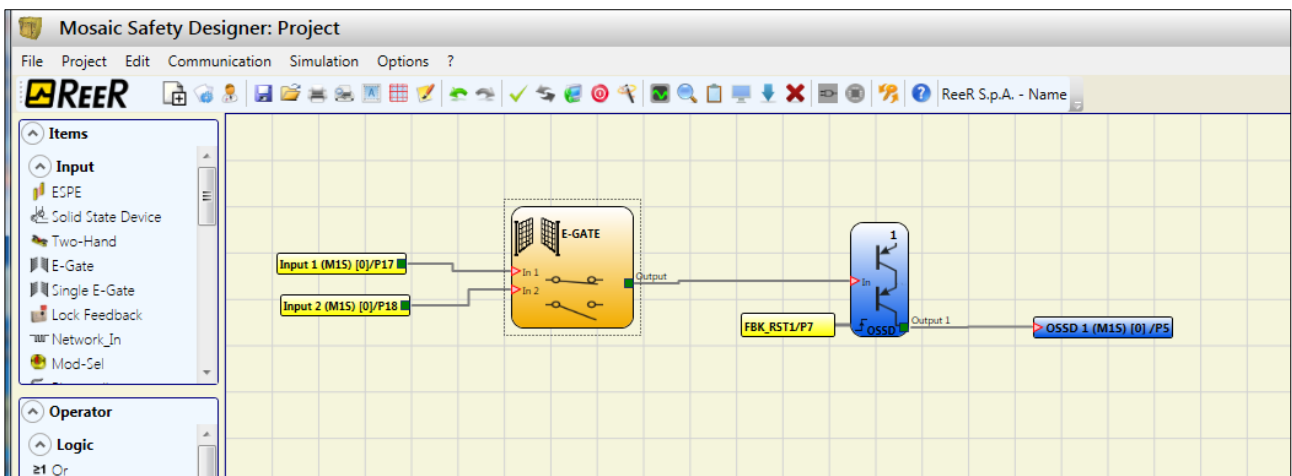
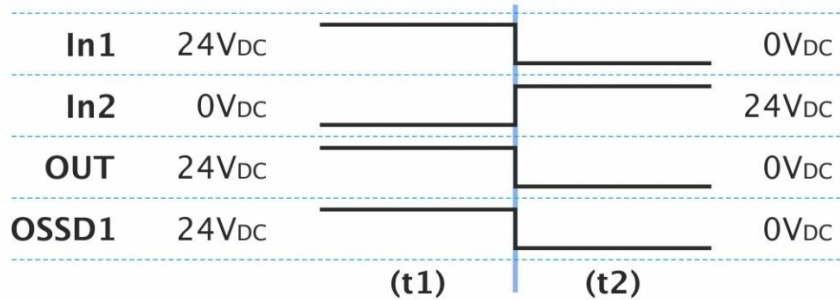

Figure 95

- (t1) In the normal operating condition (E-GATE closed) Input1 is closed, Input2 is open and the output of the E-GATE block is set to high logic level; in this mode the safety outputs (OSSD1/2) are active and the power supply to the relative terminals is 24VDC.
- (t2) When the E-GATE is physically opened, the condition of the inputs and thus of the outputs of the E-GATE block will change: (OUT= 0VDC--- >24VDC); the condition of the OSSD1 - OSSD2 safety outputs will change from 24VDC to 0VDC. If this change is detected the mobile E-GATE is connected correctly.



- For the correct installation of each external sensor/component refer to their installation manual.
- This test must be performed for each safety component in the project.



## OBJECT FUNCTION BLOCKS

### OUTPUT OBJECTS

#### OSSD (safety outputs)

OSSD safety outputs use semiconductor technology, if the input “In” is at logic level 1 (TRUE) then the “Out1” and “Out2” will be set at 24 VDC (module power supply). If the input “In” is at logic level 0 (FALSE) then the “Out1” and “Out2” will be set at 0 VDC.

➔ Each pair of OSSD outputs has a relative RESTART\_FBK input. This input must always be connected as indicated in the RESTART\_FBK paragraph.

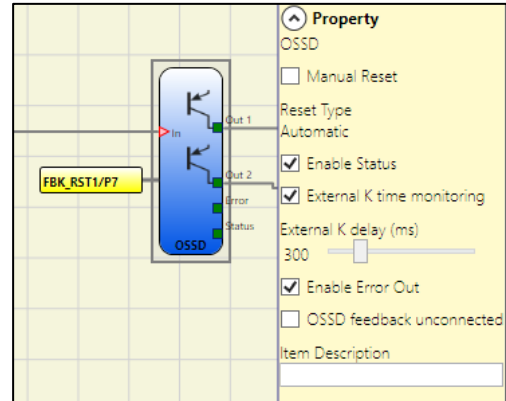

#### Parameters

**Manual Reset:** If selected this enables the request to reset each time the input signal falls. Otherwise, output Follows directly In input Signal level.

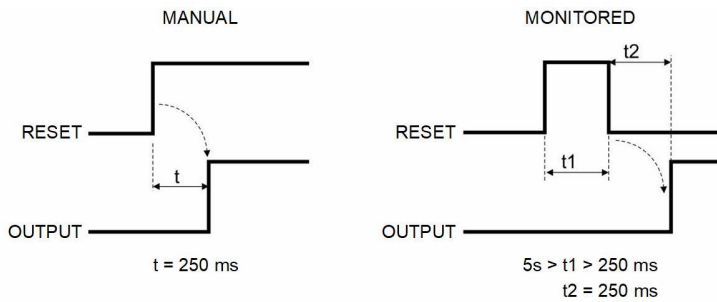

There are two types of reset: Manual and Monitored. In selecting the Manual option only signal transition from 0 to 1 is verified. If the Monitored option is selected, the double transition from 0 to 1 and back to 0 is verified.

**Enable Status:** If selected, enables the connection of the current OSSD state to any point on the schematic.

**External K time monitoring:** If selected, enables the setting of the time window within which the external feedback signal is to be monitored (according to following output conditions).

OUTPUT	FBK	ERROR	MOSAIC M1, MOSAIC M1S, MOSAIC M1S COM CLEAR LED
1	0	0	0
0	1	1	Flashing

With high level (TRUE) OUTPUT, the FBK signal must be at low level (FALSE) within the set time. Otherwise, OUTPUT is set to low level (FALSE) and the error is indicated on the master module by the flashing CLEAR LED corresponding to the OSSD in error.

If not selected, the following checks are performed:

- 1) During power on, the system verifies that the FBK signal is connected to 24 VDC.
- 2) During normal operation, the system verifies that 24 Vdc are available via the series of NC contacts of K1/K2.

The FBK signal must meet the following conditions:

- 1) 24 VDC during power on.
- 2) 24 VDC within 10 s of the TRUE/FALSE transition of the OSSD outputs.

If one of these conditions are not met, the system detects an error that can only be reset by a power cycle. This is signaled by a flashing of the CLEAR LED corresponding to the affected output.

When the NC contacts of K1/K2 are not connected, connect the FBK input to 24 VDC.

**Enable Error Out** If selected, enables the ERROR OUT output. This output is set to high level (TRUE) when an external FBK error is detected.

The Error Out signal is reset in case of one of the following events:

1. Switching on and switching off of system.
2. Activation of the RESET MOSAIC M1 operator.

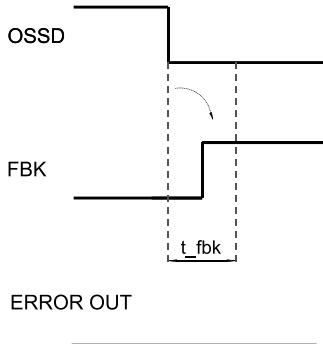

Example of OSSD with correct Feedback signal:  
In this case ERROR OUT=FALSE

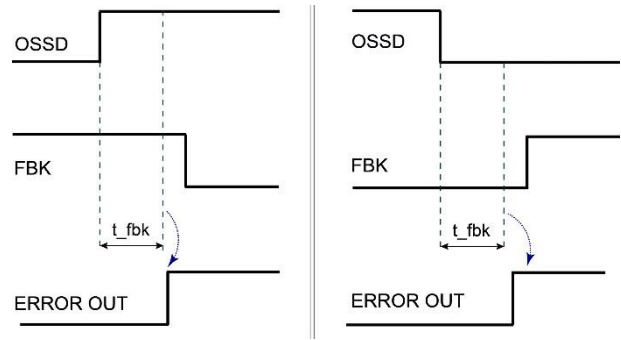

Example of OSSD with incorrect Feedback signal (k external time exceeded):  
In this case ERROR OUT=TRUE

**OSSD feedback unconnected:** If selected, the feedback must not be connected. If not selected the feedback must be connected directly to 24V or through the series of NC contacts of K1/K2.

➔ This parameter is only applicable to modules:

- MOSAIC M1 with firmware version  $\geq 4.1$
- MI802 with firmware version  $\geq 0.11$
- MO2,MO4 with firmware version  $\geq 0.7$
- MO4LHCS8 firmware version  $>0.1$

**SINGLE-DOUBLE OSSD (safety output)**

SINGLE DOUBLE OSSD safety output uses semiconductor technology if the input “In” is at logic level 1 (TRUE) then the “Out1” and “Out2” will be set at 24 VDC (module power supply).

If the input “In” is at logic level 0 (FALSE) then the “Out1” and “Out2” will be set at 0 VDC.

➔ Each SINGLE OSSD output provides a relative RESTART\_FBK input. This input, in the case of MOSAIC M1S, MOSAIC M1S COM, MI804 and MO4L appears only if the manual reset or the external K time control is activated. In the case of MO4LHCS8 instead, it always appears and must be connected as indicated in the RESTART\_FBK paragraph.

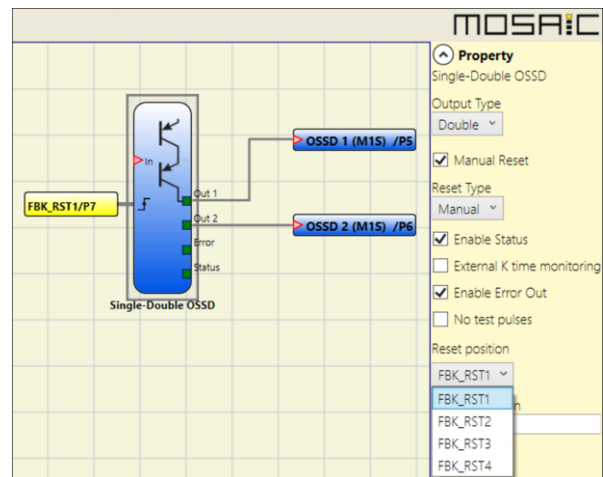

**Parameters**

**Output Type:** There is a choice of 2 different output type:

- Single Output Type
- Double Output Type

Using MOSAIC M1S, MOSAIC M1S COM, MI804, MO4L, MO4LHCS8 modules, the operator can choose between different configurations:

1. Four SINGLE OUTPUTS function blocks (*single output type*)

2. Two SINGLE OUTPUTS function blocks (*double output type*)
3. Two SINGLE OUTPUTS function blocks (*single output type*) + one SINGLE OUTPUTS function block (*double output type*)

**⚠** Using single channels OSSD, to maintain Safety Integrity Level (SIL) "3" requirements the OSSD outputs must be independent.

**⚠** Common cause failures between OSSD outputs must be excluded by observing an appropriate cable installation (i.e. separate cable paths).

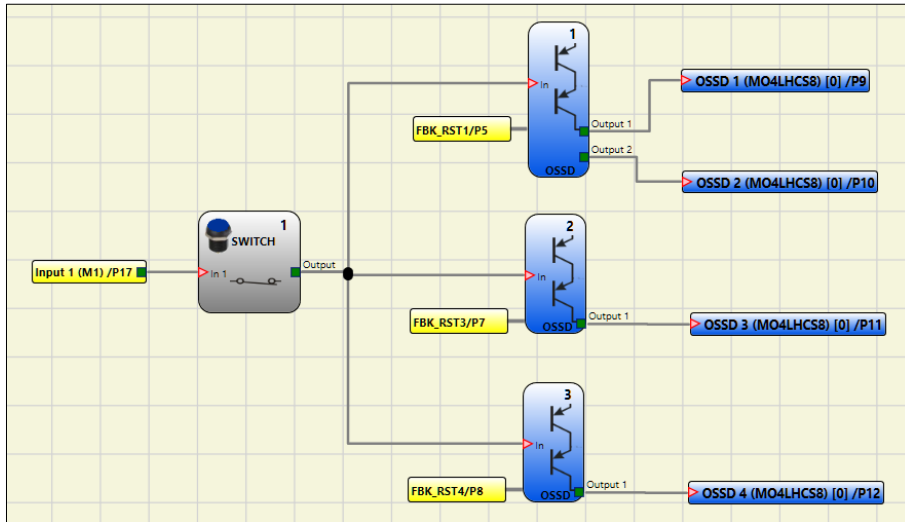

Example of project - 2 single output *type* function blocks + 1 double output *type* function blocks

Here below you can find the explanation of the MOSAIC M1S, MOSAIC M1S COM, MI8O4, MO4L, MO4LHCS8 SINGLE-OSSD configurations.

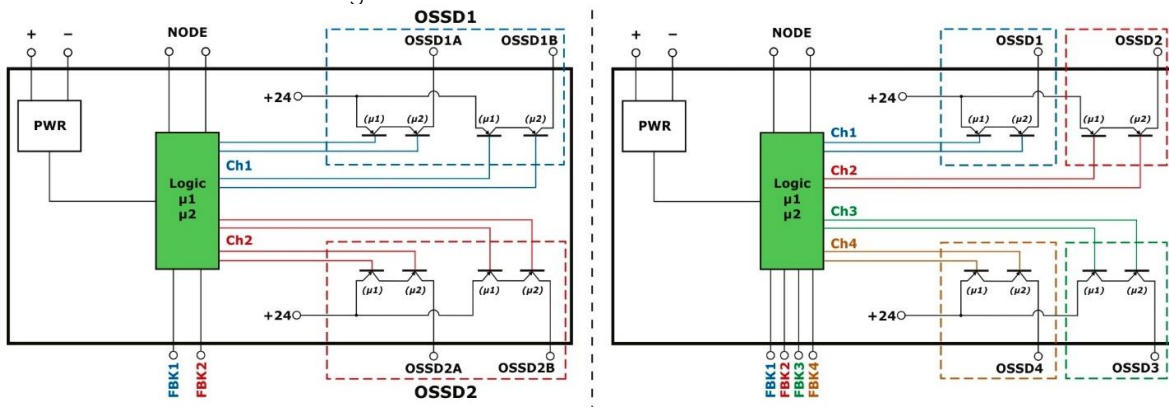

**Manual Reset:** If selected this enables the request to reset each time the input signal falls. Otherwise, output enabling directly follows In input conditions.

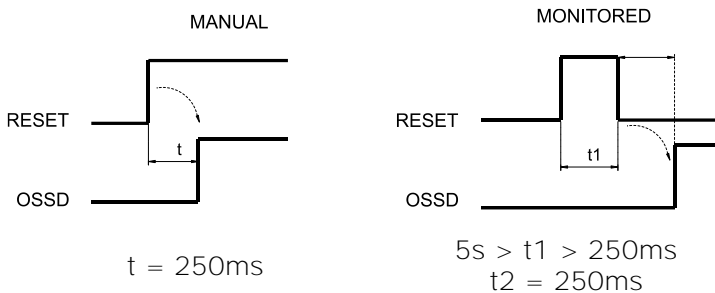

There are two types of reset: Manual and Monitored. In selecting the Manual option only signal transition from 0 to 1 is verified. If the Monitored option is selected, the double transition from 0 to 1 and back to 0 is verified.

**Enable Status:** If selected, enables the connection of the current OSSD state to any point on the schematic.

**External K time monitoring:** If selected, enables the setting of the time window within which the external feedback signal is to be monitored (according to following output conditions).

OUTPUT	FBK	ERROR	MOSAIC M1, MOSAIC M1S, MOSAIC M1S COM CLEAR LED
1	0	0	0
0	1	1	Flashing

With high level (TRUE) OUTPUT, the FBK signal must be at low level (FALSE) within the set time. Otherwise, OUTPUT is set to low level (FALSE) and the error is indicated on the master MOSAIC M1 by the flashing CLEAR LED corresponding to the OSSD in error.

**Enable Error Out:** If selected, enables the ERROR OUT output. This output is set to high level (TRUE) when an external FBK error is detected.

The Error Out signal is reset in case of one of the following events:

1. Switching on and switching off of system.
2. Activation of the RESET MOSAIC M1 operator.

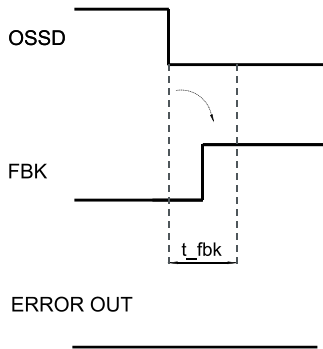

Example of OSSD with correct Feedback signal: In this case ERROR OUT=FALSE

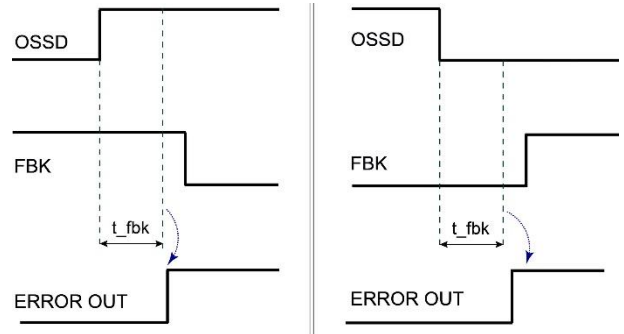

Example of OSSD with incorrect Feedback signal (k external time exceeded): In this case ERROR OUT=TRUE

**OSSD feedback unconnected:** If selected, the feedback must not be connected. If not selected the feedback must be connected directly to 24V or through the series of NC contacts of K1/K2.

➔ This parameter is only applicable to module MO4LHCS8 firmware version >0.1

**No test pulses:** if selected disables the “voltage dip” test on the OSSD safety outputs (refer to “Important note concerning OSSD Safety Outputs”, page 42).

**⚠** Selecting “no test pulse” causes the loss of the safety function of the Single-Double OSSD (function block grey colored). As a consequence the SIL will be downgraded.

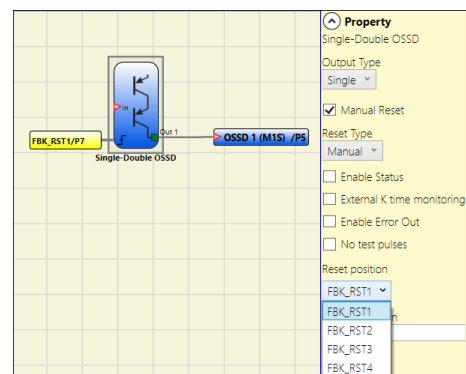
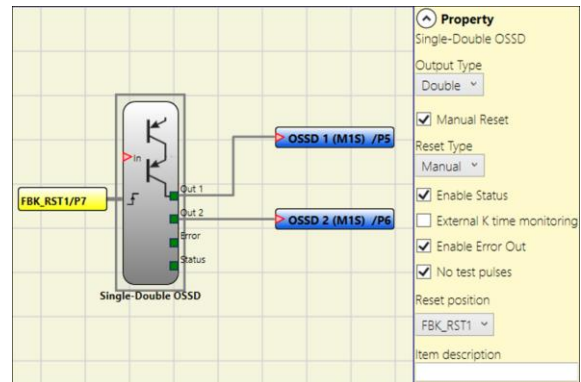

**Reset position:** (MOSAIC M1S (fw $\geq$ 7.0), MOSAIC M1S COM (fw $\geq$ 7.0), MI8O4 (fw $\geq$ 0.3), MO4L (fw $\geq$ 0.3)) allows to select the physical terminal of the module to give the reset command. You can also use the same terminal for different OSSD outputs.

➔ The unused **Feedback/Restart** Pins can be used as single inputs in the schematic (*MOSAIC M1S, MOSAIC M1S COM, M1804*).

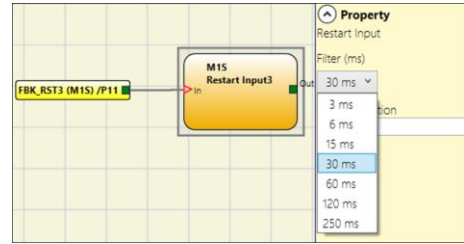

**STATUS (SIL 1/PL c output)**

STATUS output (SIL 1/PL c output) makes it possible to monitor any point on the diagram by connecting it to the input. The output is set at 24Vdc if the input is 1 (TRUE), or it is set at 0Vdc if the input is 0 (FALSE).

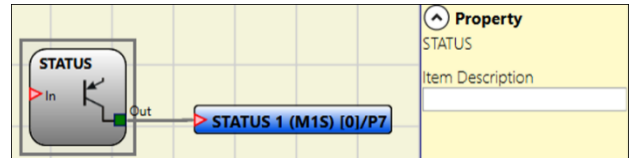

**⚠** The STATUS output reaches only the SIL 1/PL c safety level.

**FIELD BUS PROBE**

FIELD BUS PROBES collect the logical status of any point of the MSD schematic where they are attached. These information are then transmitted over the fieldbus and are represented with 4 bytes (MOSAIC M1S, MOSAIC M1S COM) or 2 bytes (MOSAIC M1). The user could choose the bit position of a particular probe within the transmitted byte. It is possible to insert a maximum of 32 probes with MOSAIC M1S/MOSAIC M1S COM and MBx fw >= 2.0, 32 probes with MOSAIC M1S COM and 16 with MOSAIC M1 or MBx fw < 2.0.

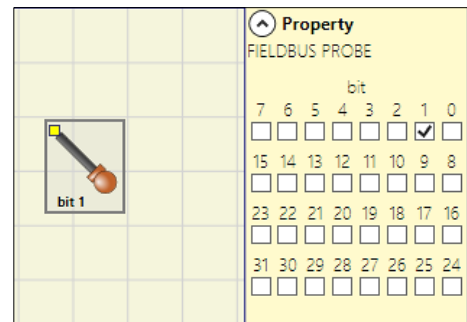

*(For more detailed information, consult the fieldbus manual available in the Reer website).*

**⚠** WARNING: the PROBE output is NOT a safety output.

RELAY

The Output RELAY Consists in a N.O. (Normally Open) contact relay. Relay contacts are closed when the input IN is equal to 1 (TRUE), otherwise they are open (FALSE).

Parameters

**Category** There is a choice of 3 different relay output categories:

Category 1. Outputs with single Category 1 relay. Each MOR4/S8 unit may have up to 4 of these outputs.

Features:

- Internal relays are monitored.
- EDM feedback not used (not requested for Category 1).
- Each output can be set as AUTO or MANUAL RESTART.

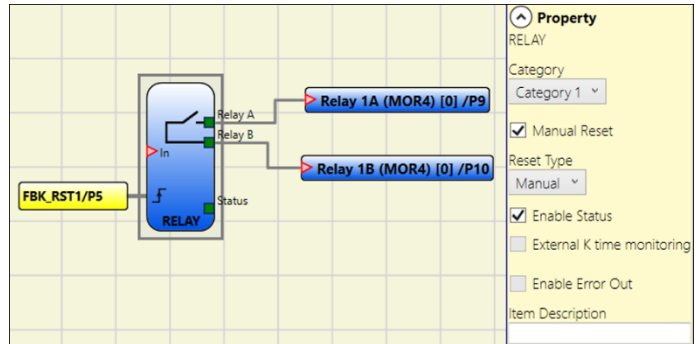

Example with external relay

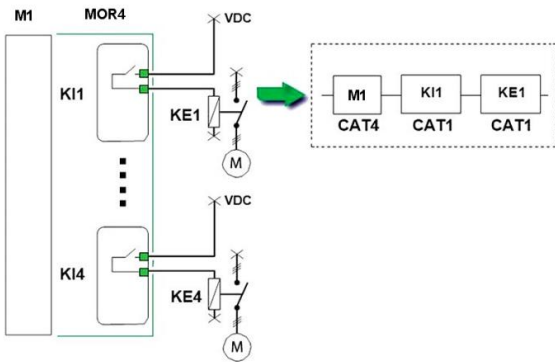

Example with the internal relay only

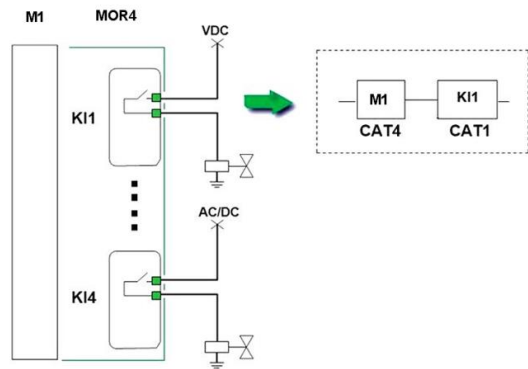

Category 2. Outputs with single Category 2 relay with OTE outputs. Each MOR4/S8 unit can have up to 4 of these outputs.

Features:

- Internal relays are always monitored.
- Monitored EDM feedback.
- The output can be configured with Manual or Automatic restart. The EDM feedback monitor cannot be activated with the manual restart.
- The feedback is monitored only if Automatic reset is selected.
- To use the manual reset, a dedicated logic must be provided. Refer to the following paragraph.

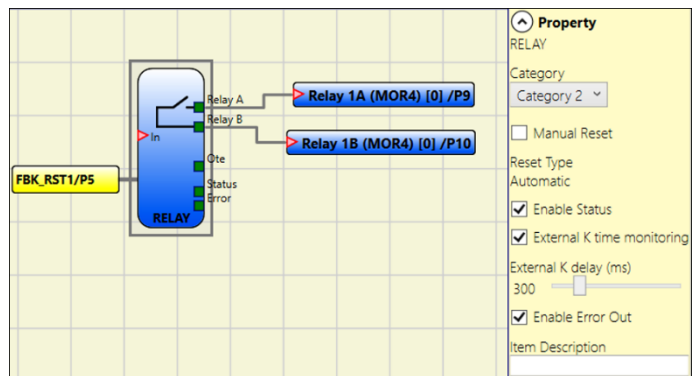

(Output Test Equipment)

➔ OTE (Output Test Equipment) with configurations of category 2 is mandatory because it is necessary for the reporting of hazardous failures in accordance with EN 13849-1: 2015.

OTE: The OTE (Output Test Equipment) output is:

- ON in normal operation
- OFF in case of an internal error or a fault associated with feedback from the external contactors (OFF). This permits to inform the machine logic with the aim of stopping the dangerous movement or at least signaling the fault to the user.

Use with RESTART: Automatic (A) or Manual (B) (Category 2)

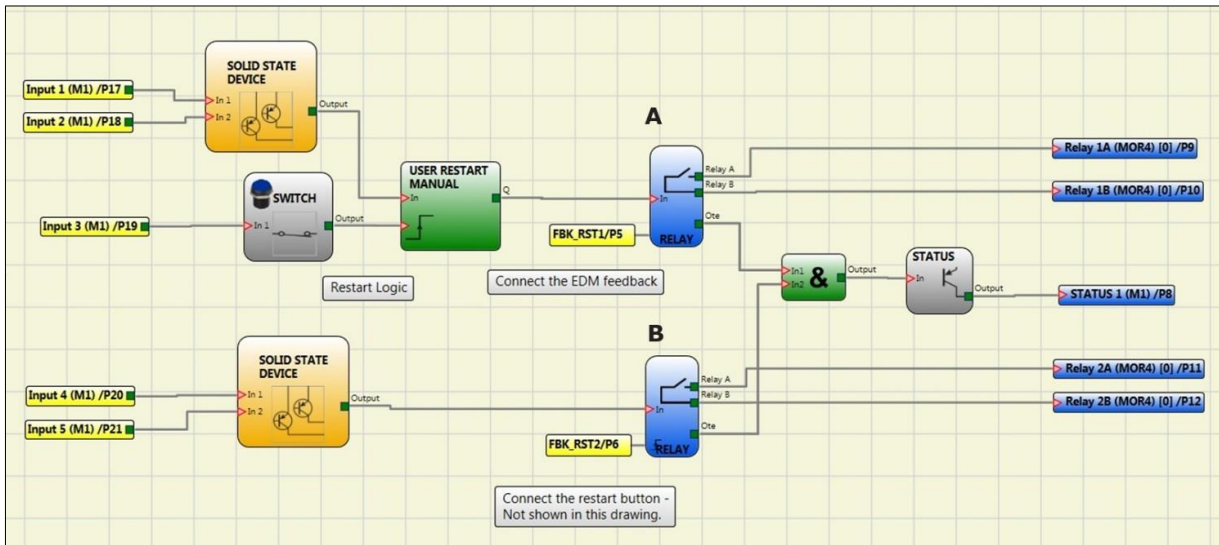
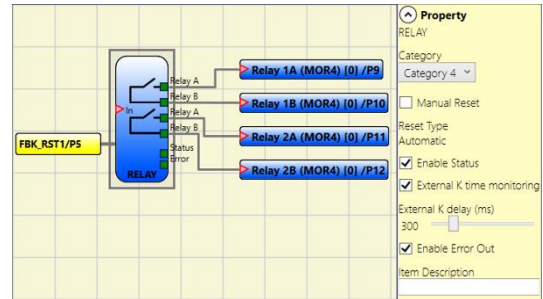

Figure 96

Category 4. Outputs with two Category 4 relays. Each MOR4/S8 unit can have up to 2 of these outputs. With this output the relays are controlled in pairs.

Features:

- 2 double channel outputs.
- Double internal relays are monitored.
- Each output can be set as AUTO or MANUAL RESTART.



➔ In order to not affect the outcome of the calculation of the PL, the inputs (sensors or safety devices) must be of a category equal to or higher than the other devices in the chain.

Example of use with only the internal relay and monitored solenoid valves.

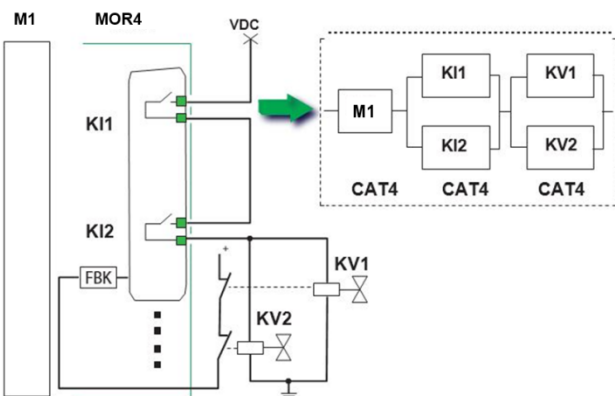

Example of use with external contactors with feedback.

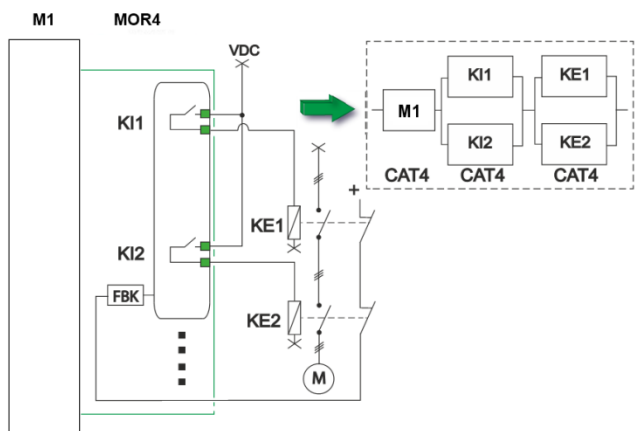

**Manual Reset:** When selected, the function requires a reset each time the function block is activated. When not selected, the enabling of the output of the function directly follows the input conditions.

- When Manual is selected, the function verifies the reset signal transition from 0 to 1.
- When Monitored is selected, the function verifies the reset signal transition from 0 to 1 to 0.

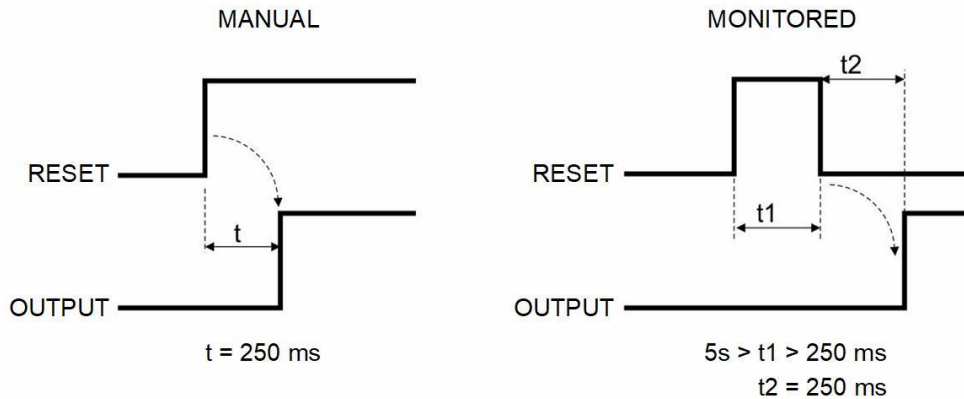

**Enable Status:** If selected, enables the connection of the current RELAY state to any point on the screen.

**External K time monitoring:** When this is selected it monitors the switching of external contactors:

- With category 1, monitoring of external contactors cannot be enabled.
- With category 4, monitoring of external contactors is enabled and cannot be disabled.

**External K delay (ms):** Select the Maximum delay the external contactors are allowed to introduce. This value can be used to check the maximum delay between switching of the internal relays and switching of the external contactors (during both activation and deactivation).

**Enable Error Out** If selected, enables the ERROR OUT output. This output is set to high level (TRUE) when an external FBK error is detected.

The Error Out signal is reset in case of one of the following events:

1. Switching on and switching off of system.
2. Activation of the RESET MOSAIC M1 operator.

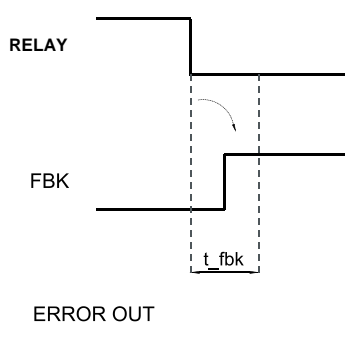

Example of RELAY with correct Feedback signal:  
In this case ERROR OUT=FALSE

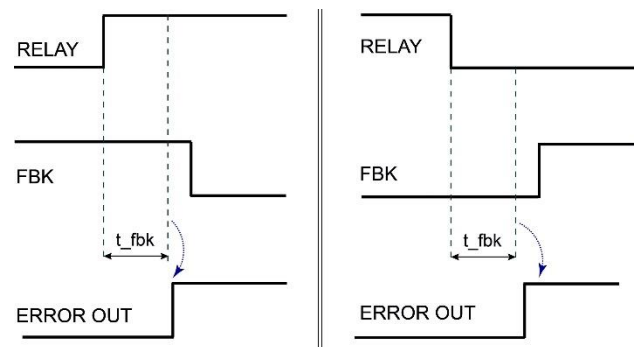

Example of RELAY with incorrect Feedback signal  
(k external time exceeded):  
In this case ERROR OUT=TRUE



INPUT OBJECTS

**E-STOP (emergency stop)**

E-STOP function block verifies an emergency stop device inputs status. If the emergency stop button has been pressed the output is 0 (FALSE). If not the output is 1 (TRUE).

**Parameters**

**Input type:**

- Single NC - allows connection of one-way emergency stops
- Double NC - allows connection of two-way emergency stops .

**Manual reset:** If selected this enables the request to reset each time the emergency stop is activated. Otherwise, enabling of the output directly follows the input conditions.

There are two types of reset: Manual and Monitored. When Manual is selected the system only verifies the signal's transition from 0 to 1. If Monitored is selected the double transition from 0 to 1 and then back to 0 is verified.

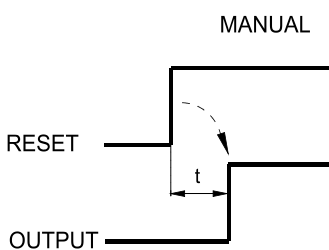
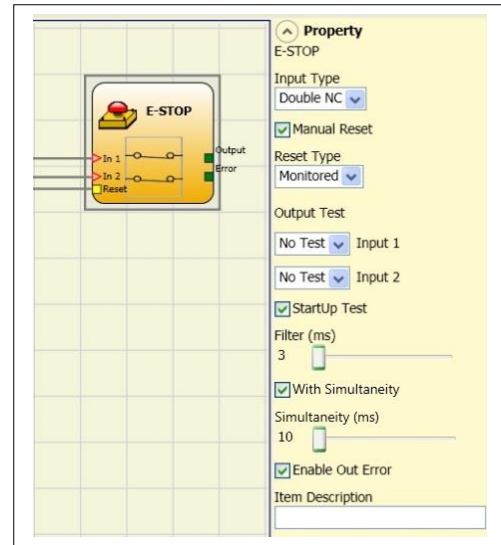

$t = 250ms$

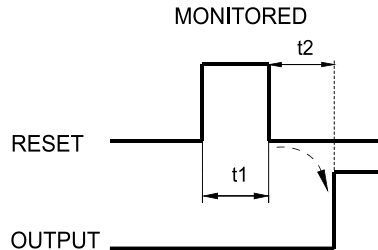

$t1 > 250ms$   
 $t2 = 250ms$

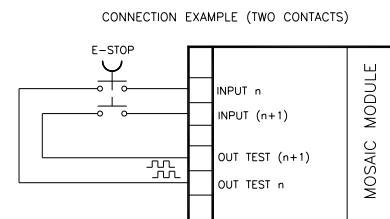
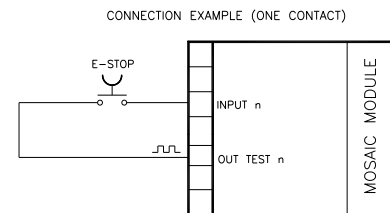

**➔ WARNING:** If the Manual Reset is active, a consecutive Input have to be used. Example: Input 1 and Input 2 are used for the fuctional block, then Input 3 have to be used for the Reset Input.

**Output test:** This is used to select which test output signals are to be sent to the emergency stop (mushroom pushbutton). This additional test makes it possible to detect and manage any short-circuits between the lines. This additional control permits detection and management of any short-circuits between the lines. To enable this control, the test output signals must be configured (amongst those available).

**Test at start-up:** If selected this enables the test at start-up of the external component (emergency stop). This test is performed by pressing and releasing the pushbutton to run a complete function test and enable the output. This test is only requested at machine start-up (when the unit is switched on).

**Filter (ms):** This is used to filter the signals coming from the emergency stop. The filter can be configured to between 3 and 250 ms and eliminates any bouncing on the contacts. The length of the filter affects the calculation of the unit's total response time.

**With Simultaneity (only with Double\_NC Input type):** If selected this activates the test to verify concurrent switching of the signals coming from the emergency stop.

**Simultaneity (only with Double\_NC Input type) (ms):** This is only active if the previous parameter is enabled. It defines the maximum time (in ms) between the switching of two different signals from the emergency stop.

**Enable Error Out:** If selected reports a fault detected by the function block.

**Item description:** This allows a description of the component's function to be entered. The text is displayed in the top part of the symbol.

**E-GATE (safety gate device)**

E-GATE function block verifies a mobile guard or safety gate device input status. If the mobile guard or safety gate is open, the output is 0 (FALSE). Otherwise the output is 1 (TRUE).

**Parameters**

**Input type:**

- Double NC - Allows connection of components with two NC contacts
- Double NC/NO - Allows connection of components with one NO contact and one NC.

- ➔ With inactive input (block with Output FALSE), connect:
- Contact NO to terminal corresponding to IN1.
  - Contact NC to terminal corresponding to IN2.

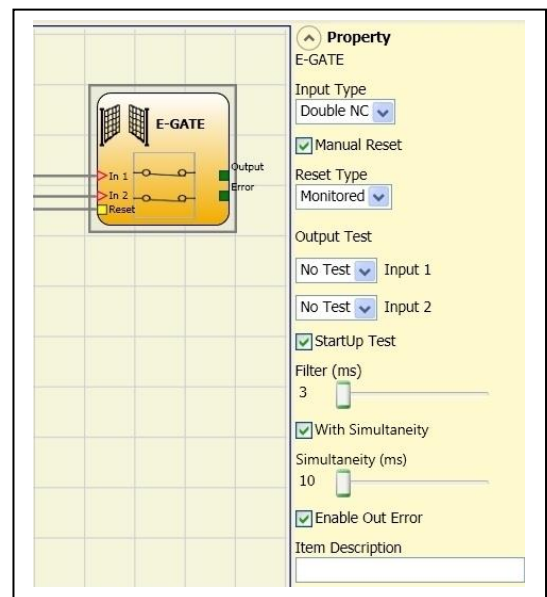

**Enable reset:** If selected this enables the request to reset each time the mobile guard/safety gate is activated. Otherwise, enabling of the output directly follows the input conditions. There are two types of reset: Manual and Monitored. When Manual is selected the system only verifies the signal's transition from 0 to 1. If Monitored is selected the double transition from 0 to 1 and then back to 0 is verified.

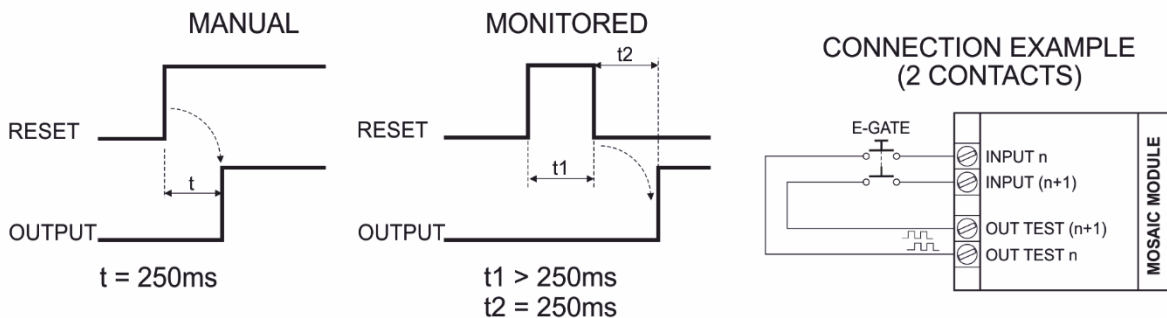

english

➔ **WARNING:** If the Manual Reset is active, a consecutive Input have to be used.  
 Example: Input 1 and Input 2 are used for the fuctional block, then Input 3 have to be used for the Reset Input.

**Output test:** This is used to select which test output signals are to be sent to the component contacts. This additional control permits detection and management of any short-circuits between the lines. To enable this control, the test output signals must be configured (amongst those available).

**Test at start-up:** If selected this enables the test at start-up of the external component. This test is performed by opening the mobile guard or safety gate to run a complete function test and enable the output. This test is only requested at machine start-up (when the unit is switched on).

**Filter (ms):** This is used to filter the signals coming from the external contacts. The filter can be configured to between 3 and 250 ms and eliminates any bouncing on the contacts. The length of the filter affects the calculation of the unit's total response time.

**With Simultaneity:** If selected this activates the test to verify concurrent switching of the signals coming from the external contacts.

**Simultaneity (ms):** This is only active if the previous parameter is enabled. It defines the maximum time (in ms) between the switching of two different signals from the external contacts.

**Enable Error Out:** If selected reports a fault detected by the function block.

**Item description:** This allows a description of the component's function to be entered. The text is displayed in the top part of the symbol.

**SINGLE E-GATE (safety gate device)**

SINGLE E-GATE function block verifies a mobile guard or safety gate device input status. If the mobile guard or safety gate is open, the output is 0 (FALSE). Otherwise the output is 1 (TRUE).

**Parameters**

**Enable reset:** If selected this enables the request to reset each time the mobile guard/safety gate is activated. Otherwise, enabling of the output directly follows the input conditions.

There are two types of reset: Manual and Monitored. When Manual is selected the system only verifies the signal's transition from 0 to 1. If Monitored is selected the double transition from 0 to 1 and then back to 0 is verified.

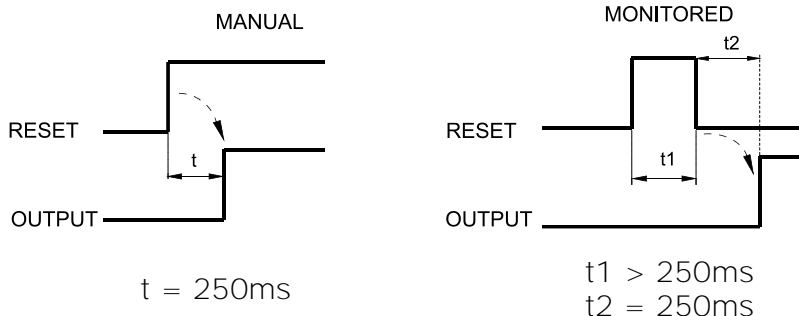
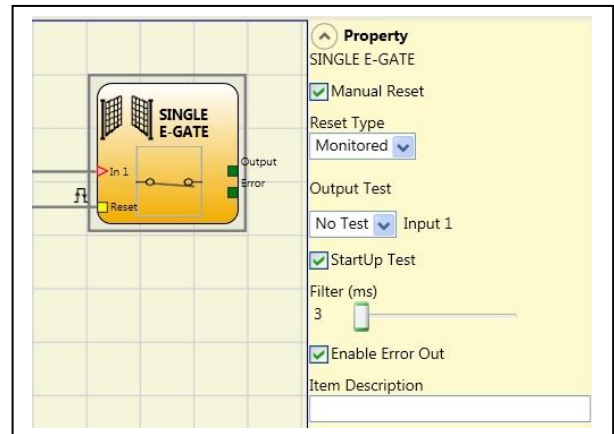

➔ **WARNING:** If the Manual Reset is active, a consecutive Input have to be used. Example : Input 1 and Input 2 are used for the fuctional block, then Input 3 have to be used for the Reset Input.

**Output test:** This is used to select which test output signals are to be sent to the component contacts. This additional control permits detection and management of any short-circuits between the lines. To enable this control, the test output signals must be configured (amongst those available).

**Test at start-up:** If selected this enables the test at start-up of the external component. This test is performed by opening the mobile guard or safety gate to run a complete function test and enable the output. This test is only requested at machine start-up (when the unit is switched on).

**Filter (ms):** This is used to filter the signals coming from the external contacts. The filter can be configured to between 3 and 250 ms and eliminates any bouncing on the contacts. The length of the filter affects the calculation of the unit's total response time.

**Enable Error Out:** If selected reports a fault detected by the function block.

**Item description:** This allows a description of the component's function to be entered. The text is displayed in the top part of the symbol.

**LOCK FEEDBACK**

The function block LOCK FEEDBACK verifies the lock status of the guard lock device for mobile guard or safety gate. In the case where the inputs indicate that the guard is locked the Output will be 1 (TRUE). Otherwise the output is 0 (FALSE).

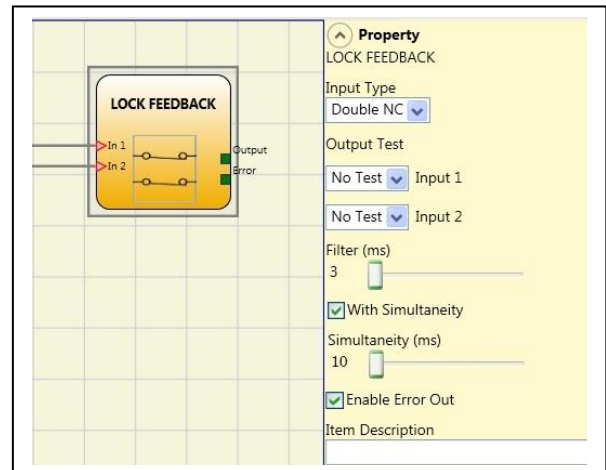

**Parameters**

**Input type**

- Single NC - Allows connection of components with one NC contact;
- Double NC - Allows connection of components with two NC contacts.
- Double NC/NO - Allows connection of components with one NO contact and one NC.

➔ **With inactive input (guard unlocked), connect:**

- Contact NO to terminal corresponding to IN1
- Contact NC to terminal corresponding to IN2.

**Output test:** This is used to select which test output signals are to be sent to the component contacts. This additional control permits detection and management of any short-circuits between the lines. To enable this control, the test output signals must be configured (amongst those available).

**Filter (ms):** This is used to filter the signals coming from the external contacts. The filter can be configured to between 3 and 250 ms and eliminates any bouncing on the contacts. The length of the filter affects the calculation of the unit's total response time.

**With Simultaneity (only with Double\_NC or Double NC/NO Input type):** If selected this activates the test to verify concurrent switching of the signals coming from the external contacts.

**Simultaneity (ms) (only with Double\_NC or Double NC/NO Input type):** This is only active if the previous parameter is enabled. It defines the maximum time (in ms) between the switching of two different signals from the external contacts.

**Enable Error Out:** If selected reports a fault detected by the function block.

**Item description:** This allows a description of the component's function to be entered. The text is displayed in the top part of the symbol.

**ENABLE (enable key)**

ENABLE function block verifies a manual key device Input status. If the key is not turned the output is 0 (FALSE). Otherwise the output is 1 (TRUE).

**Parameters**

**Input type**

- Single NO - Allows connection of components with one NO contact;
- Double NO - Allows connection of components with two NO contacts.

**Enable reset:** If selected this enables the request to reset each time the command is activated. Otherwise, enabling of the output directly follows the input conditions.

There are two types of reset: Manual and Monitored. When Manual is selected the system only verifies the signal's transition from 0 to 1.

If Monitored is selected the double transition from 0 to 1 and then back to 0 is verified.

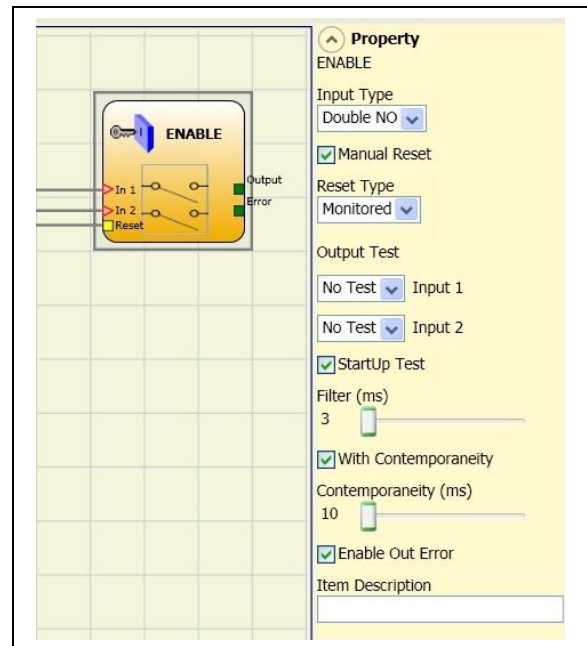

➔ **WARNING:** If the Manual Reset is active, a consecutive Input have to be used.  
 Example : Input 1 and Input 2 are used for the fuctional block, then Input 3 have to be used for the Reset Input.

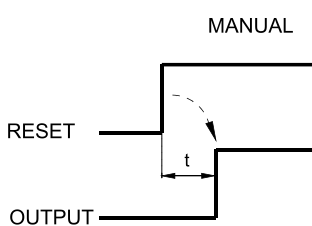

t = 250ms

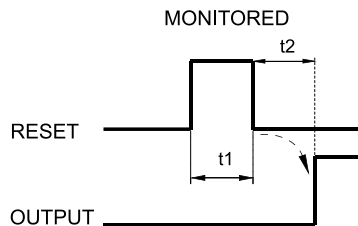

t1 > 250ms  
t2 = 250ms

CONNECTION EXAMPLE (ONE CONTACT)

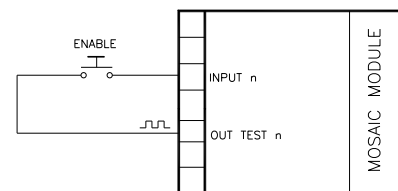

CONNECTION EXAMPLE (TWO CONTACTS)

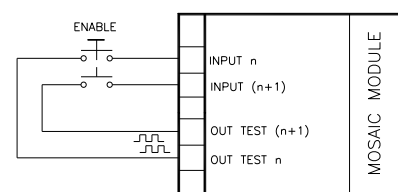

**Output test:** This is used to select which test output signals are to be sent to the component contacts. This additional control permits detection and management of any short-circuits

between the lines. To enable this control, the test output signals must be configured (amongst those available).

**Test at start-up:** If selected this enables the test at start-up of the external component. This test is performed by opening and activating the enable key to run a complete function test and enable the output. This test is only requested at machine start-up (when the unit is switched on).

**Filter (ms):** This is used to filter the signals coming from the external contacts. The filter can be configured to between 3 and 250 ms and eliminates any bouncing on the contacts. The length of the filter affects the calculation of the unit's total response time.

**With Simultaneity (only with Double NO Input type):** If selected this activates the test to verify concurrent switching of the signals coming from the external contacts.

**Simultaneity (ms) (only with Double NO Input type):** This is only active if the previous parameter is enabled. It defines the maximum time (in ms) between the switching of two different signals from the external contacts.

**Enable Error Out:** If selected reports a fault detected by the function block.

**Item description:** This allows a description of the component's function to be entered. The text is displayed in the top part of the symbol.

**ESPE (optoelectronic safety light curtain / laser scanner)**

ESPE function block verifies an optoelectronic safety light curtain (or laser scanner) inputs state. If the area protected by the light curtain is occupied, (light curtain outputs FALSE) the output is 0 (FALSE). Otherwise, with the area clear and outputs to 1 (TRUE) the output is 1 (TRUE).

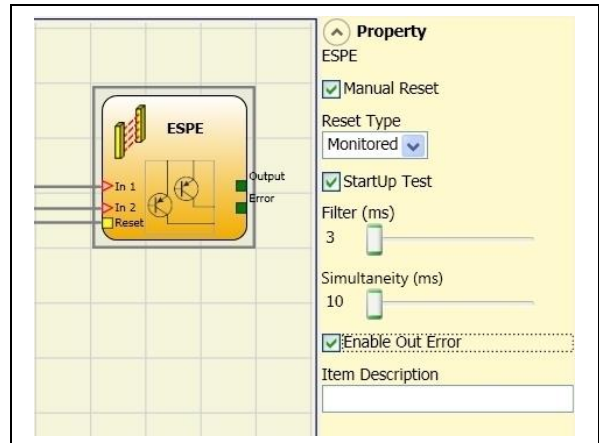

**Parameters**

**Enable reset:** If selected this enables the request to reset each time the area protected by the safety light curtain is occupied. Otherwise, enabling of the output directly follows the input conditions.

There are two types of reset: Manual and Monitored. When Manual is selected the system only verifies the signal's transition from 0 to 1. If Monitored is selected the double transition from 0 to 1 and then back to 0 is verified.

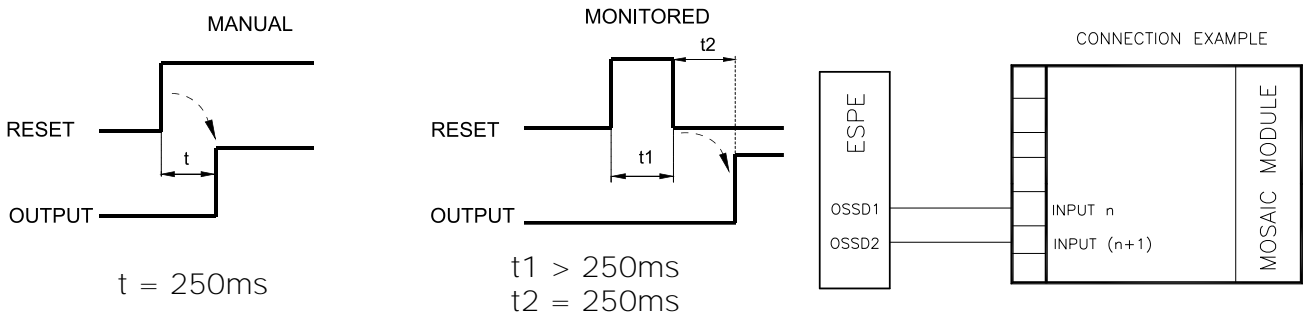

**WARNING:** If the Manual Reset is active, a consecutive Input have to be used. Example: Input 1 and Input 2 are used for the functional block, then Input 3 have to be used for the Reset Input.

OUT TEST signals cannot be used in case of safety static output ESPE because the control is carried out from the ESPE.

**Test at start-up:** If selected this enables the test at start-up of the safety light curtain. This test is performed by occupying and clearing the area protected by the safety light curtain to run a complete function test and enable the output. This test is only requested at machine start-up (when the unit is switched on).

**Filter (ms):** This is used to filter the signals coming from the safety light curtain. The filter can be configured to between 3 and 250 ms and eliminates any bouncing on the contacts. The length of the filter affects the calculation of the unit's total response time.

**Simultaneity (ms):** always active. Determines the maximum permissible time (ms) between switching of the various signals from the external contacts of the device.

**Enable Error Out:** If selected reports a fault detected by the function block.

**Item description:** This allows a description of the component's function to be entered. The text is displayed in the top part of the symbol.

**FOOTSWITCH (safety pedal)**

The FOOTSWITCH function block verifies the status of the inputs of a safety pedal device. If the pedal is not pressed the output is 0 (FALSE). Otherwise the output is 1 (TRUE).

**Parameters**

**Input type:**

- Single NC - Allows connection of pedals with one NC contact
- Single NO - Allows connection of pedals with one NO contact.
- Double NC - Allows connection of pedals with two NC contacts
- Double NC/NO - Allows connection of pedals with one NO contact and one NC.

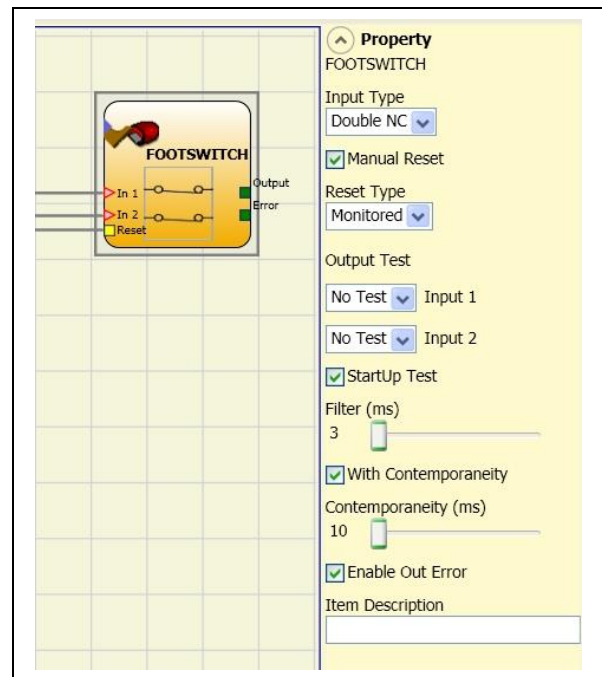

**Double NC/NO correct connection**

- Contact NC to terminal corresponding to IN1
- Contact NO to terminal corresponding to IN2

**Manual reset:** If selected this enables the request to reset each time the safety pedal is activated. Otherwise, enabling of the output directly follows the input conditions.

There are two types of reset: Manual and Monitored. When Manual is selected the system only verifies the signal's transition from 0 to 1. If Monitored is selected the double transition from 0 to 1 and then back to 0 is verified.

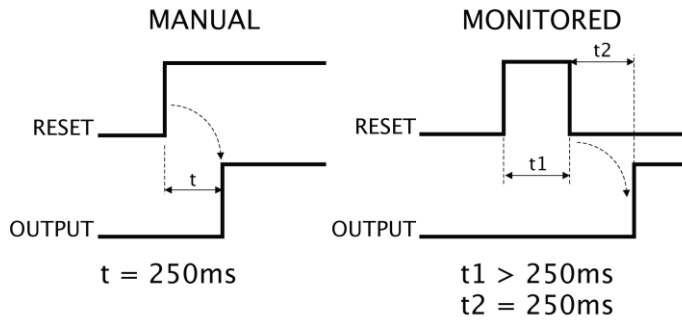

CONNECTION EXAMPLE (1 CONTACT)

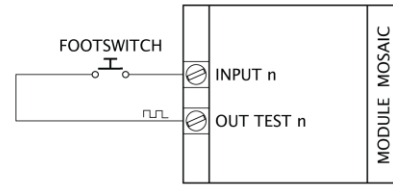

CONNECTION EXAMPLE (2 CONTACTS)

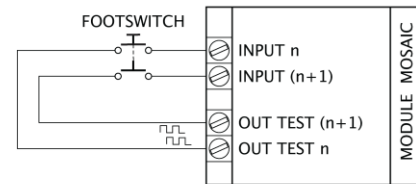

➔ **WARNING:** If the Manual Reset is active, a consecutive Input have to be used. Example: Input 1 and Input 2 are used for the functional block, then Input 3 have to be used for the Reset Input.

**Output test:** This is used to select which test output signals are to be sent to the component contacts. This additional control permits detection and management of any short-circuits between the lines. To enable this control, the test output signals must be configured (amongst those available).

**Test at start-up:** If selected this enables the test at start-up of the external component. This test is performed by pressing and releasing the footswitch to run a complete function test and enable the output. This test is only requested at machine start-up (when the unit is switched on).

**Filter (ms):** This is used to filter the signals coming from the external contacts. The filter can be configured to between 3 and 250 ms and eliminates any bouncing on the contacts. The length of the filter affects the calculation of the unit's total response time.

**With Simultaneity (only with Double NC or Double NC-NO Input type):** If selected this activates the test to verify concurrent switching of the signals coming from the external contacts.

**Simultaneity (ms):** This is only active if the previous parameter is enabled. It defines the maximum time (in ms) between the switching of two different signals from the external contacts.

**Enable Error Out:** If selected reports a fault detected by the function block.

**Item description:** This allows a description of the component's function to be entered. The text is displayed in the top part of the symbol.



### MOD-SEL (safety selector)

The MOD-SEL function block verifies the status of the inputs from a mode selector (up to 4 inputs): If only one input is 1 (TRUE) the corresponding output is also 1 (TRUE). In all other cases, and thus when all inputs are 0 (FALSE) or more than one input is 1 (TRUE) all the outputs are 0 (FALSE).

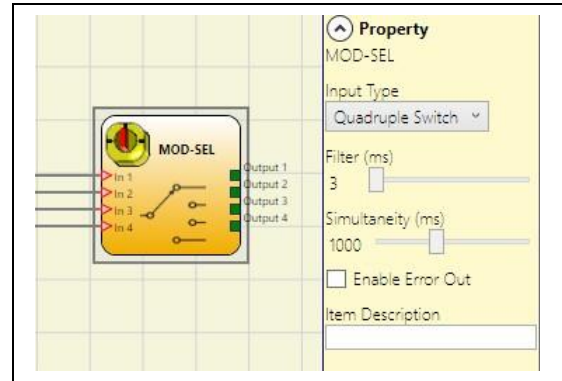

#### Parameters

##### Input type:

- Double selector - Allows connection of two-way mode selectors.
- Triple selector - Allows connection of three-way mode selectors.
- Quadruple selector - Allows connection of four-way mode selectors.

**Filter (ms):** This is used to filter the signals coming from the mode selector. The filter can be configured to between 3 and 250 ms and eliminates any bouncing on the contacts. The length of the filter affects the calculation of the unit's total response time.

**Simultaneity (ms):** always active. Determines the maximum permissible time (ms) between switching of the various signals from the external contacts of the device.

**Enable Error Out:** If selected reports a fault detected by the function block.

**Item description:** This allows a description of the component's function to be entered. The text is displayed in the top part of the symbol.

### PHOTOCELL (safety photocell)

The PHOTOCELL function block verifies the status of the inputs of an optoelectronic safety photocell. If the beam of the photocell is occupied (photocell output FALSE) the output is 0 (FALSE). Otherwise with the beam clear and an output of 1 (TRUE) the output is 1 (TRUE).

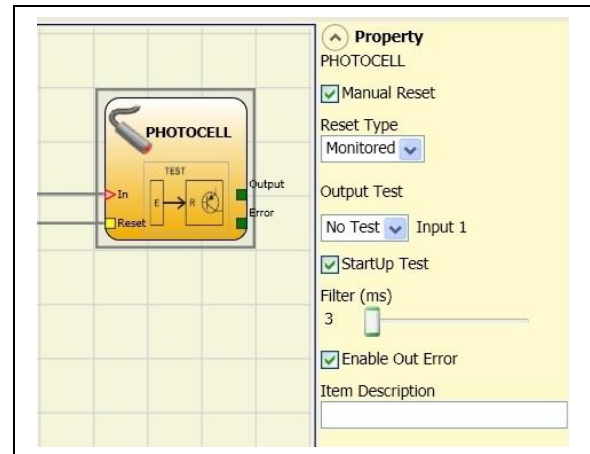

#### Parameters

**Manual reset:** If selected this enables the request to reset each time safety photocell is activated. Otherwise, enabling of the output directly follows the input conditions.

There are two types of reset: Manual and Monitored. When Manual is selected the system only verifies the signal's transition from 0 to 1. If Monitored is selected the double transition from 0 to 1 and then back to 0 is verified.

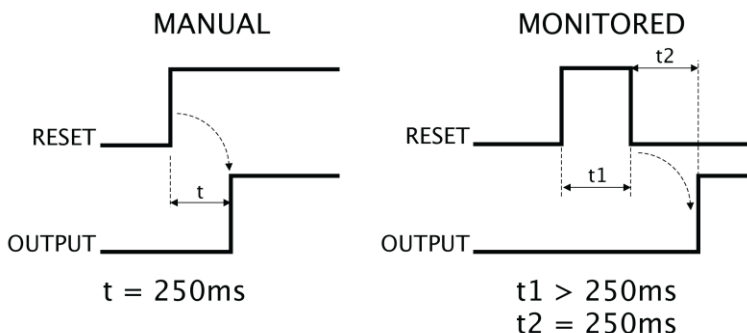

#### CONNECTION EXAMPLE

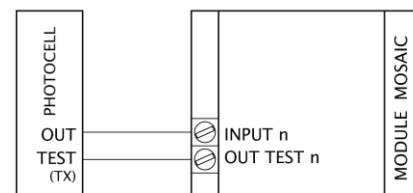

- ➔ An output test signal is mandatory and can be selected from the 4 possible Test Output 1...4.
- ➔ If the Manual Reset is active, a consecutive Input have to be used. Example: Input 1 is used for the functional block, then Input 2 have to be used for the Reset Input.
- ➔ The response time of the photocell must be >2ms and <20ms.

**Output test:** This is used to select which test output are to be sent to the photocell test input. This additional control permits detection and management of any short-circuits between the lines. To enable this control, the test output signals must be configured (amongst those available).

**Test at start-up:** If selected this enables the test at start-up of the external component. This test is performed by occupying and clearing the photocell to run a complete function test and enable the output. This test is only requested at machine start-up (when the unit is switched on).

**Filter (ms):** This is used to filter the signals coming from the external contacts. The filter can be configured to between 3 and 250 ms and eliminates any bouncing on the contacts. The length of the filter affects the calculation of the unit's total response time.

**Enable Error Out:** If selected reports a fault detected by the function block.

**Item description:** This allows a description of the component's function to be entered. The text is displayed in the top part of the symbol.

---

### **TWO-HAND (bimanual control)**

---

The TWO HAND function block verifies the status of the inputs of a two hand control switch. Only if both the press-buttons are pressed within 500 ms the output is 1 (TRUE). Otherwise the output is 0 (FALSE).

**Input type:**

- Double NO – Allows connection of two-hand switch with one NO contact for each button (EN 574 III A).
- Quadruple NC-NO – Allows connection of two-hand switch with a double NO/NC contact for each button (EN 574 III C).

---

### **Quadruple NC/NO correct connection**

---

- Contacts NO to terminal corresponding to IN1, IN3
- Contacts NC to terminal corresponding to IN2, IN4

---

### **Parameters**

---

**Output test:** This is used to select which test output signals are to be sent to the component contacts. This additional control permits detection and management of any short-circuits between the lines. To enable this control, the test output signals must be configured (amongst those available).

**Test at start-up:** If selected this enables the test at start-up of the external component. This test is performed by pressing the two buttons (within 500 ms) and releasing them to run a complete function test and enable the output. This test is only requested at machine start-up (when the unit is switched on).

**Filter (ms):** This is used to filter the signals coming from the mode selector. The filter can be configured to between 3 and 250 ms and eliminates any bouncing on the contacts. The length of the filter affects the calculation of the unit's total response time.

**Enable Error Out:** If selected reports a fault detected by the function block.

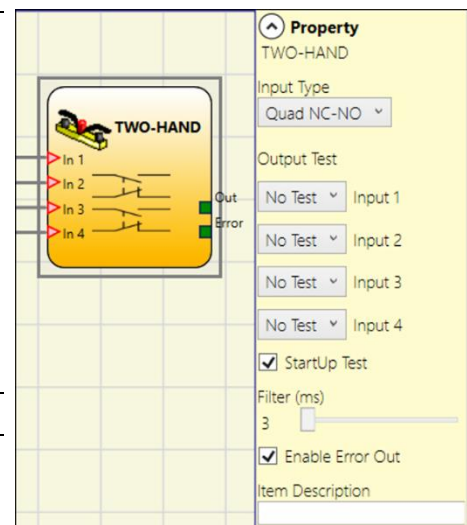

**Item description:** This allows a description of the component's function to be entered. The text is displayed in the top part of the symbol.

**NETWORK\_IN**

This functional block implements a Network connection input interface; it generates an LL1 in the OUT output when the line is high, otherwise an LLO.

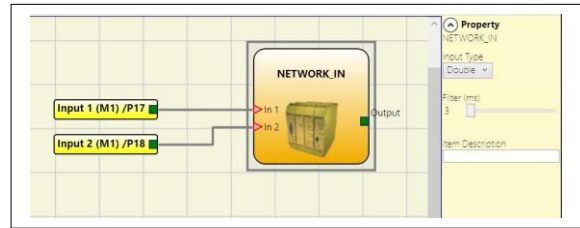

**Parameters**

**Type of input:**

- Single - enables the connection of Signalling outputs of an external MOSAIC M1, MOSAIC M1S, MOSAIC M1S COM unit.
- Double - enables the connection of OSSD outputs of an external MOSAIC M1, MOSAIC M1S, MOSAIC M1S COM unit.

**Filter (ms):** Enables the filtering of signals from an external MOSAIC M1, MOSAIC M1S, MOSAIC M1S COM unit.

This filter can be set to between 3 and 250ms. The length of the filter affects the calculation of the unit's total response time.

- ➔ This input can only be allocated on MOSAIC M1, MOSAIC M1S, MOSAIC M1S COM and can't be used on expansion modules
- ➔ This input must be used when Mosaic OSSD outputs are connected to the inputs of a second downstream Mosaic or together with the NETWORK operator.

**SENSOR**

The SENSOR function block verifies the status of the input of a sensor (not a safety sensor). If the beam of the sensor is occupied (sensor output FALSE) the output is 0. Otherwise, with the beam clear and an output of 1 (TRUE) then the output is 1.

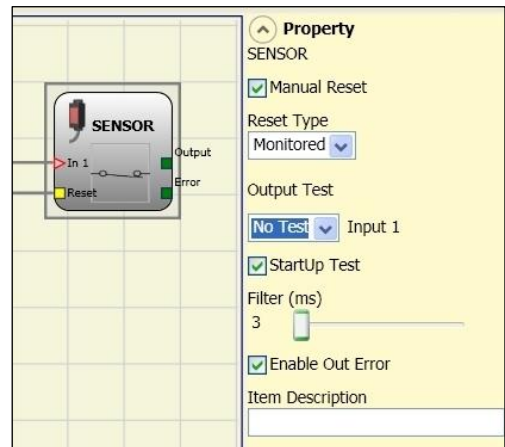

**Parameters**

**Manual reset:** If selected this enables the request to reset each time the area protected by the sensor is occupied. Otherwise, enabling of the output directly follows the input conditions.

There are two types of reset: Manual and Monitored. When Manual is selected the system only verifies the signal's transition from 0 to 1. If Monitored is selected the double transition from 0 to 1 and then back to 0 is verified.

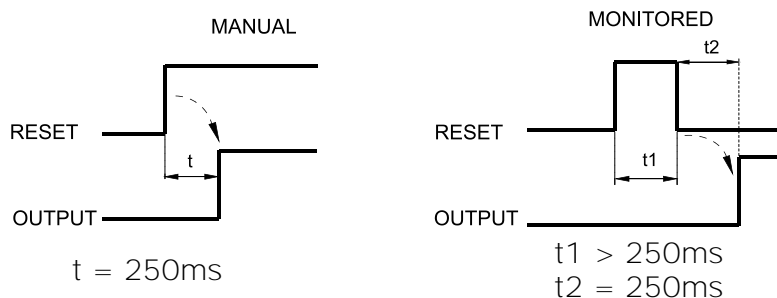

➔ **WARNING:** If the Manual Reset is active, a consecutive Input have to be used. Example: Input 1 is used for the functional block, then Input 2 have to be used for the Reset Input.

**Output test:** This is used to select which test output signals are to be sent to the sensor. This additional control permits detection and management of any short-circuits between the lines. To enable this control, the test output signals must be configured (amongst those available).

**Test at start-up:** If selected this enables the test at start-up of the sensor. This test is performed by occupying and clearing the area protected by the sensor to run a complete function test and enable the output. This test is only requested at machine start-up (when the unit is switched on).

**Filter (ms):** This is used to filter the signals coming from the sensor. The filter can be configured to between 3 and 250 ms and eliminates any bouncing on the contacts. The length of the filter affects the calculation of the unit's total response time.

**Enable Error Out:** If selected reports a fault detected by the function block.

**Item description:** This allows a description of the component's function to be entered. The text is displayed in the top part of the symbol.

**S-MAT (safety mat)**

The S-MAT function block verifies the status of the inputs of a safety mat. If a person stands on the mat the output is 0 (FALSE). Otherwise, with the mat clear, the output is 1 (TRUE).

**Parameters**

**Manual reset:** If selected this enables the request to reset each time the mobile guard/safety gate is activated. Otherwise, enabling of the output directly follows the input conditions.

There are two types of reset: Manual and Monitored. When Manual is selected the system only verifies the signal's transition from 0 to 1. If Monitored is selected the double transition from 0 to 1 and then back to 0 is verified.

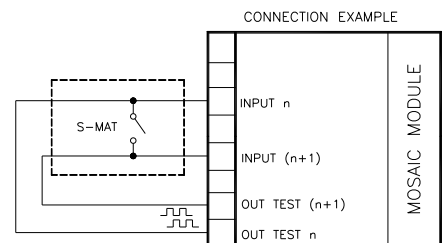
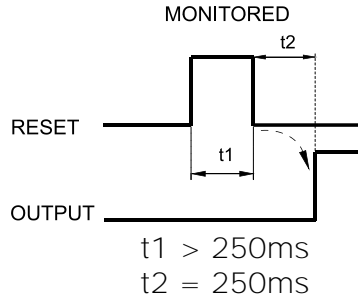
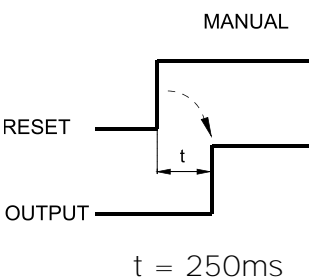
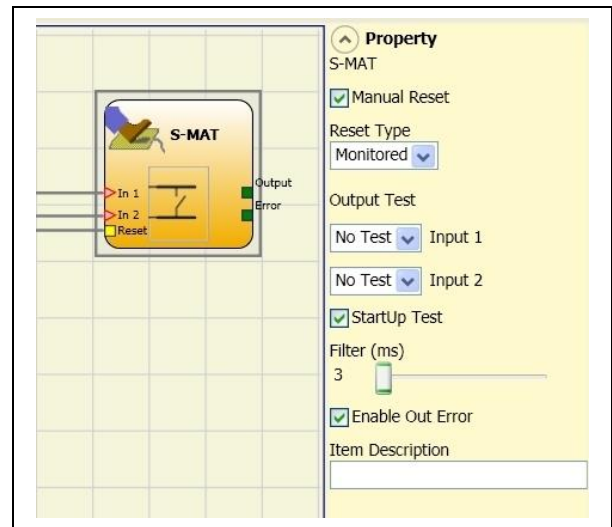

- ➔ If the Manual Reset is active, a consecutive Input have to be used. Example: Input 1 and Input 2 are used for the functional block, then Input 3 have to be used for the Reset Input.
- ➔ Two output test signals are mandatory. Each output OUT TEST can be connected to only one input S-MAT (it is not allowed parallel connection of 2 inputs).
- ➔ The function block S-MAT cannot be used with 2-wire components and termination resistance.

english

**Output test:** This is used to select which test output signals are to be sent to the s-mat contact. This additional control permits detection and management of any short-circuits between the lines. To enable this control, the test output signals must be configured (amongst those available). Test signals are mandatory.

**Test at start-up:** If selected this enables the test at start-up of the external component. This test is performed by pressing and releasing the safety mat to run a complete function test and enable the output. This test is only requested at machine start-up (when the unit is switched on).

**Filter (ms):** This is used to filter the signals coming from the external contacts. The filter can be configured to between 3 and 250 ms and eliminates any bouncing on the contacts. The length of the filter affects the calculation of the unit's total response time.

**Enable Error Out:** If selected reports a fault detected by the function block.

**Item description:** This allows a description of the component's function to be entered. The text is displayed in the top part of the symbol.

**SWITCH**

SWITCH function block verifies the input status of a pushbutton or switch (NOT SAFETY SWITCHES). If the pushbutton is pressed the output is 1 (TRUE). Otherwise, the output is 0 (FALSE).

**Parameters**

**Manual reset:** If selected this enables the request to reset each time the device is activated. Otherwise, enabling of the output directly follows the input conditions.

There are two types of reset: Manual and Monitored. When Manual is selected the system only verifies the signal's transition from 0 to 1.

If Monitored is selected the double transition from 0 to 1 and then back to 0 is verified.

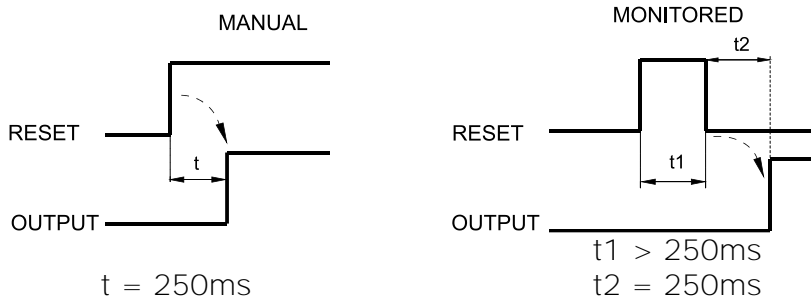
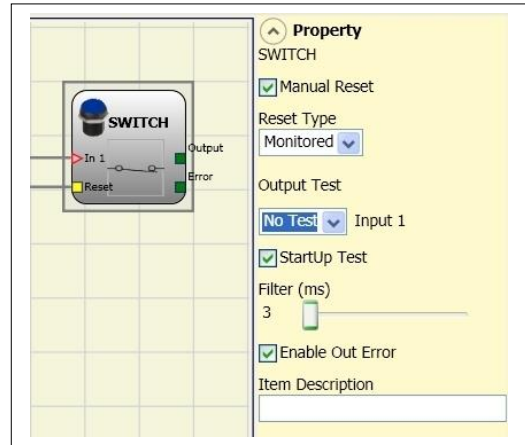

➔ **WARNING:** If the Manual Reset is active, a consecutive Input have to be used. Example: Input 1 is used for the functional block, then Input 2 have to be used for the Reset Input.

**Output test:** This is used to select which test output signals are to be sent to the switch. This additional control permits detection and management of any short-circuits between the lines. To enable this control, the test output signals must be configured (amongst those available).

**Test at start-up:** If selected this enables the test at start-up of the switch. This test is performed by opening and closing the switch contact to run a complete function test and

enable the output. This test is only requested at machine start-up (when the unit is switched on).

**Filter (ms):** This is used to filter the signals coming from the switch. The filter can be configured to between 3 and 250ms and eliminates any bouncing on the contacts. The length of the filter affects the calculation of the unit's total response time.

**Enable Error Out:** If selected reports a fault detected by the function block.

**Item description:** This allows a description of the component's function to be entered. The text is displayed in the top part of the symbol.

**ENABLING GRIP SWITCH**

The ENABLING GRIP functional block checks the status of the In<sub>x</sub> inputs of an enabling grip. If this is not gripped (position 1) or is gripped completely (position 3), the OUTPUT will be 0 (FALSE). If it is gripped to middle position (position 2), the OUTPUT will be 1 (TRUE). Refer to truth tables at the bottom of the page.

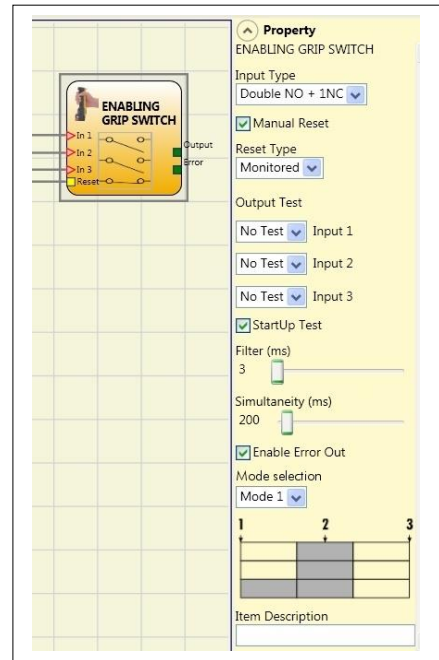

➔ The ENABLING GRIP functional block requires that the assigned module has a minimum Firmware version as Table below:

MOSAIC M1	MI8O2	MI8	MI16	MI12T8
1.0	0.4	0.4	0.4	0.0

**Parameters**

**Type of inputs:**

- Double NO – Permits connection of an enabling grip with 2 NO contacts.
- Double NO+1NC – Permits connection of an enabling grip switch with 2 NO contacts + 1 NC contact.

**Test outputs:** Permits selection of the test output signals to be sent to the enabling grip. This additional control permits detection and management of any short-circuits between the lines. To enable this control, the test output signals must be configured (amongst those available).

**Power-on test:** If selected, enables the power-on test of the external component (Enabling Grip). To run the test, the device must be gripped and released to carry out a complete functional check and enable the Output terminal. This control is required only at machine start-up (power-on of the module).

**Simultaneity (ms):** always active. Determines the maximum permissible time (ms) between switching of the various signals from the external contacts of the device.

**Filter (ms):** Permits filtering of signals from the device control. This filter can be set to between 3 and 250ms and eliminates any rebounds on the contacts. The duration of the filter affects calculation of module total response time.

**Table mode 1 (device 2NO + 1NC)**

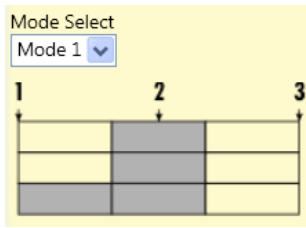

POSITION 1: enabling grip fully released  
 POSITION 2: enabling grip pressed to middle position  
 POSITION 3: enabling grip fully pressed

Input	Position		
	1	2	3
IN1	0	1	0
IN2	0	1	0
IN3	1	1	0
OUT	0	1	0

**Table mode 1 (device 2NO + 1NC)**

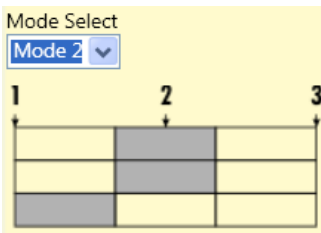

POSITION 1: enabling grip fully released  
 POSITION 2: enabling grip pressed to middle position  
 POSITION 3: enabling grip fully pressed

Input	Position		Input	1
	1	Input		
IN1	0	1	0	0
IN2	0	1	0	0
IN3	1	0	0	0
OUT	0	1	0	0

**Enable Error Out:** If selected reports a fault detected by the function block.

**Item description:** Permits insertion of a descriptive text of the function of the component. This text will be displayed in the top part of the symbol.

**TESTABLE SAFETY DEVICE**

The TESTABLE SAFETY DEVICE functional block checks the status of the Inx inputs of a single or double safety sensor, both NO and NC. Refer to the tables below to check type of sensor and behaviour.

(single NC)



IN1	OUT
0	0
1	1

(single NO)

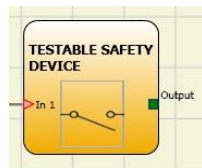

IN1	OUT
0	0
1	1

(double NC)

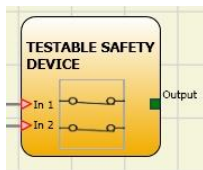

IN1	IN2	OUT	Simultaneity error *
0	0	0	-
0	1	0	X
1	0	0	X
1	1	1	-

(double NC-NO)



IN1	IN2	OUT	Simultaneity error *
0	0	0	X
0	1	0	-
1	0	1	-
1	1	0	X

\* *Simultaneity error = the maximum time between switching of the single contacts has been exceeded.*

**Parameters**

**Manual Reset:** If selected, enables the reset request after each activation of the device. Otherwise, enabling of the output follows directly the conditions of the inputs. Reset may be of two types: Manual and Monitored. Selecting the Manual option, only transition of the signal from 0 to 1 is checked. If Monitored is selected, double transition from 0 to 1 and return to 0 is checked.

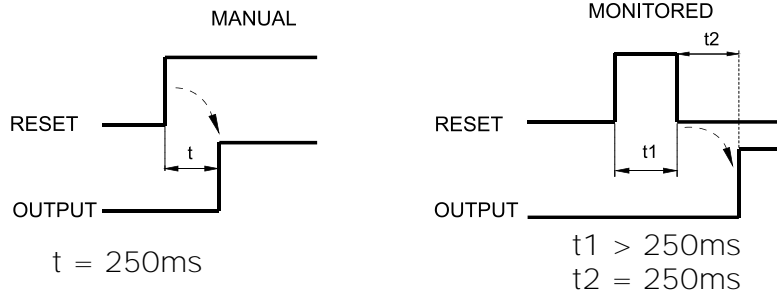

➔ **WARNING:** if Reset is enabled, the input consecutive to those used by the functional block must be used. For example: If inputs 1 and 2 are used for the functional block, input 3 must be used for Reset.

**Power-on test:** If selected, enables the power-on test of the device. This test requires activation and de-activation of the device in order to run a complete functional check and enable the Output terminal. This test is required only at machine start-up (power-on of the module).

**Filter (ms):** Permits filtering of signals from the device. This filter can be set to between 3 and 250 ms and eliminates any rebounds on the contacts. The duration of the filter affects calculation of module total response time.

**With simultaneity:** If selected, activates control of simultaneity between switching of signals from the device.

**Simultaneity (ms):** Is active only if the previous parameter is enabled. Determines the maximum permissible time (ms) between switching of two different signals from the sensor.

**Enable Error Out:** If selected reports a fault detected by the function block.

**Item description:** Permits insertion of a descriptive text of the function of the component. This text will be displayed in the top part of the symbol.



## SOLID STATE DEVICE

The SOLID STATE DEVICE functional block checks the status of the Inx inputs. If the inputs are at 24VDC, the Output will be 1 (TRUE), otherwise the OUTPUT will be 0 (FALSE).

### Parameters

**Manual Reset:** If selected, enables the reset request after each safety function activation. Otherwise, enabling of the output follows directly the conditions of the inputs. Reset may be of two types: Manual and Monitored. Selecting the Manual option, only transition of the signal from 0 to 1 is checked. If Monitored is selected, double transition from 0 to 1 and return to 0 is checked.

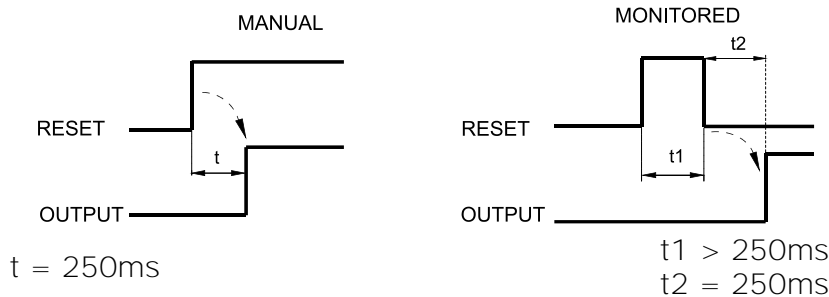
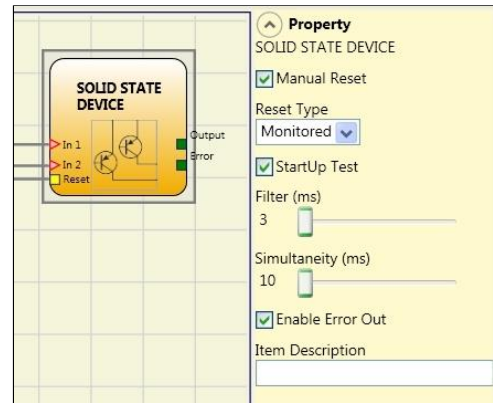

**WARNING:** if Reset is enabled, the input consecutive to those used by the functional block must be used. For example: if inputs 1 and 2 are used for the functional block, input 3 must be used for Reset.

**Power-on test:** If selected, enables the power-on test of the safety device. This test requires activation and de-activation of the device in order to run a complete functional check and enable the Output terminal. This test is required only at machine start-up (power-on of the module)

**Filter (ms):** Permits filtering of signals from the safety device. This filter can be set to between 3 and 250 ms and eliminates any rebounds on the contacts. The duration of the filter affects calculation of module total response time.

**Simultaneity (ms):** always active. Determines the maximum permissible time (ms) between switching of the various signals from the external contacts of the device.

**Enable Error Out:** If selected reports a fault detected by the function block.

**Item description:** Permits insertion of a descriptive text of the function of the component. This text will be displayed in the top part of the symbol.

**RESTART INPUT**

The element can be used as a digital input (in addition to the 8 available on MOSAIC M1S (fw $\geq$ 7.0), MOSAIC M1S COM (fw $\geq$ 7.0), MI804 (fw $\geq$ 0.3)) and connected to any external device.

The usable inputs are referred to RESTART\_FBK signals of MOSAIC M1S (fw $\geq$ 7.0), MOSAIC M1S COM (fw $\geq$ 7.0), MI804 (fw $\geq$ 0.3).

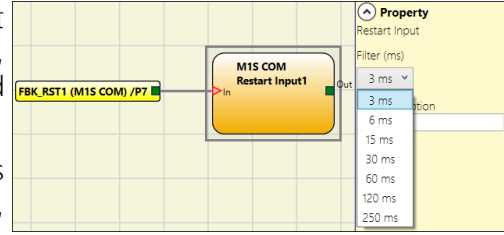

**Parameters**

**Filter (ms):** Permits filtering of signals from the external device. This filter can be set to between 3 and 250 ms and eliminates any rebounds on the contacts. The duration of the filter affects calculation of module total response time.

**FIELDBUS INPUT**

Element that permits insertion of a non-safety input whose status is modified via the fieldbus.

It is possible to insert a maximum of 32 virtual inputs with MOSAIC M1S/MOSAIC M1S COM and MBx fw  $\geq$  2.0, 32 virtual inputs with MOSAIC M1S COM and 8 with MOSAIC M1 or MBx fw  $<$  2.0.

The bit on which status is to be modified must be selected for each.

On the fieldbus the states are represented with 4 bytes with MOSAIC M1S, MOSAIC M1S COM and 1 byte with MOSAIC M1.

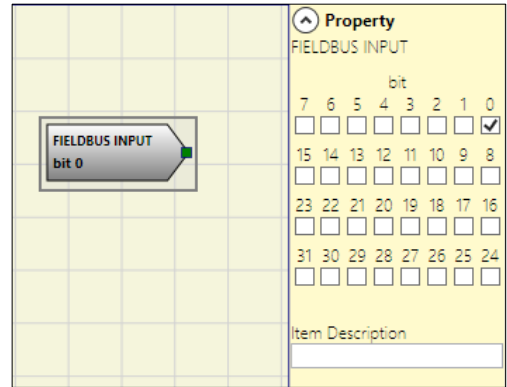

*(For more detailed information, consult the fieldbus manual available in Reer website).*

**WARNING:** the FIELDBUS INPUT is NOT a safety input.

**LLO-LL1**

These allow a predefined logical level to be entered on a component's input.

LLO -> logical level 0

LL1 -> logical level 1



**IMPORTANT:** LLO and LL1 cannot be used to disable the logical ports in the diagram.

---

**COMMENTS**

---

This item allows a description to be entered and placed in any point of the diagram.

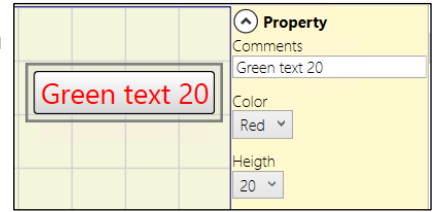

---

**Parameters**

---

**Comment:** If selected, it can be filled with the desired comment.

**Color:** select the color of the comment text.

**Height:** select the dimension of the comment text.

---

**TITLE**

---

Automatically adds the name of the manufacturer, the designer, the project name and the CRC.



SPEED CONTROL TYPE FUNCTION BLOCKS

Warning concerning safety

- ⚠** An external error or malfunction deriving from encoder/proximity or its wiring, does not necessarily involve a change of safety status of the normal output (i.e. “Zero”) of the function block. Failures or malfunctions of encoder/proximity switch or its wiring are then recognized by the module, managed and specified via the diagnostic bit on every function block (“Enable Error Out”).
- ⚠** To ensure the safety features the diagnostic bit has to be used in the configuration program created by the user to cause a possible deactivation of the outputs if the axis is working. In absence of encoder/proximity external anomalies, Error bit will be equal to 0 (zero).
- ⚠** In presence of encoder/proximity external anomalies, error\_out bit will be equal to 1 (one):

  - Absence of encoder or proximity.
  - Absence of one or more wiring from encoder/proximity.
  - Absence of encoder power supply (only model with TTL external power supply).
  - Error of congruence frequencies between signals from encoder/proximity.
  - Phase error between signals from the encoder or duty cycle error of a single phase.

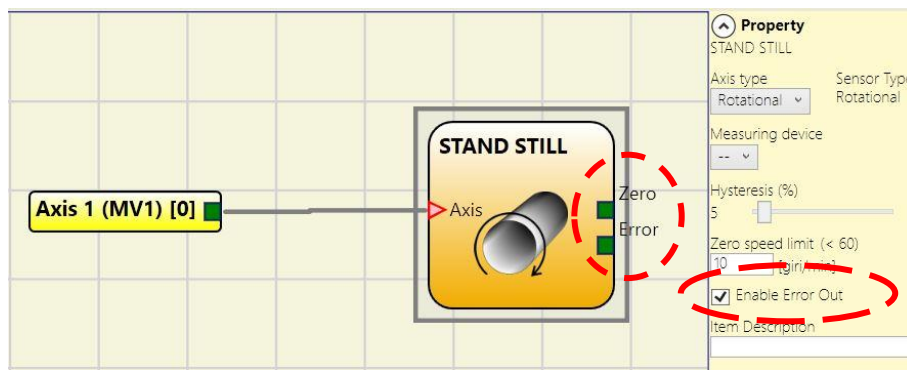
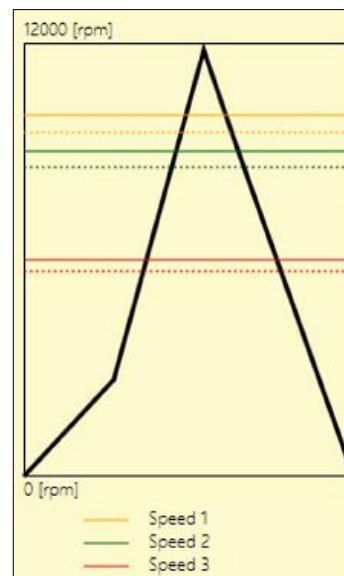

Figure 97 – Example of speed control functional block with Error Out enabled

Note concerning Speed Control Functional Blocks

Starting from the MSD 1.8.0 Software Version the Speed Control Functional Blocks provide a graphical visualization of the configured thresholds.

In the figure on the right it is represented an example of a 3 thresholds graphical diagram. The solid line represents the threshold value while the dotted line represents how much hysteresis is applied to the threshold value.



## SPEED CONTROL

The Speed Control function block monitors the speed of a device generating an output O (FALSE) when the measured speed exceeds a predetermined threshold. When the speed is below the predetermined threshold the output will be 1 (TRUE).

### Parameters

**Axis type:** It defines the type of axis controlled by the device. It will be Linear in the case of a translation and will be rotational in the case of motion around an axis.

**Sensor Type:** When the previous parameter is Linear, the Sensor Type defines the type of sensor connected to the module inputs. It can be rotational (e.g. shaft encoder) or Linear (e.g. optical array). These choices allows to set other parameters explained later.

**Measuring device:** It defines the type of sensor(s) used. The possible choices are:

- Encoder
- Proximity
- Encoder+Proximity
- Proximity1+ Proximity2
- Encoder1+ Encoder2

**Sin/Cos: Disable Analog check:** When a Sin/Cos Module is used, it is possible to disable the analog verification  $\sin^2\theta + \cos^2\theta$ , carrying out a simplified plausibility check of the Encoder signals.

**⚠ When analogue control is disabled, the diagnostic coverage decreases.**

**⚠ In addition, the safety level of the project drops from: SIL 3->SIL 2 / PL e->PL d. Please refer to chapter "Important safety instructions".**

**Enable direction:** (Available only when at least one Encoder input is present): when checked, the DIR output is enabled on the function block. This output will be 1 (TRUE) when the axis rotates Counterclockwise and will be 0 (FALSE) when the axis rotates Clockwise.

**Direction decision:** It defines the direction of rotation for which the set thresholds are made active. The possible choices are:

- Bidirectional
- Clockwise
- Counterclockwise

If Bidirectional is selected, the excess of the set threshold is detected whether the axis rotates clockwise or counterclockwise.

Selecting Clockwise or Counterclockwise, this is detected only when the axis rotates in the selected direction.

**Threshold number:** It allows you to enter the number of thresholds for the maximum value of speed. Changing this value will increase/decrease the number of thresholds that can be entered from:

1 to 8 with MOSAIC M1 fw >= 4.0, MOSAIC M1S fw >=5.1 and MVx fw >= 2.0, with MOSAIC M1S COM and MVx fw >= 2.0

f <sub>Hz</sub>	Measurement	Verification
f <sub>1u</sub>	166,667	166,667
f <sub>1n</sub>	158,334	158,334

f <sub>Hz</sub>	Measurement	Verification
f <sub>2u</sub>	333,333	333,333
f <sub>2n</sub>	316,666	316,666

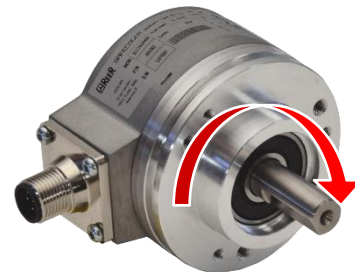

Example of CLOCKWISE axis rotation

### 2 threshold settings

In1	Threshold no.
0	Speed 1
1	Speed 2

### Up to 4 threshold settings

In2	In1	Threshold no.
0	0	Speed 1
0	1	Speed 2
1	0	Speed 3
1	1	Speed 4

1 to 4 with MOSAIC M1 fw <4.0 or MOSAIC M1S< 5.1 or MVx fw < 2.0. In the case of thresholds greater than 1, the input pins for the selection of the specific threshold will appear in the lower part of the function block. Let the user to choose which threshold has to be enabled.

Up to 8 threshold settings

In3	In2	In1	Threshold no.
0	0	0	Speed 1
0	0	1	Speed 2
0	1	0	Speed 3
0	1	1	Speed 4
1	0	0	Speed 5
1	0	1	Speed 6
1	1	0	Speed 7
1	1	1	Speed 8

Pitch: If the Axis Type chosen was linear and rotational, this field allows you to enter the sensor pitch to obtain a conversion between sensor revolutions and distance travelled.

Proximity choice: It allows you to choose the type of proximity sensor from PNP, NPN, Normally Open (NA) and Normally Closed (NC), with 3 or 4 wires.

- No Proxy
- PNP 3-wire NC
- PNP 3-wire NO
- NPN 3-wire NO
- NPN 3-wire NC
- PNP 4-wire NC/NO
- NPN 4-wire NC/NO
- PNP/NPN 4-wire NC/NC
- PNP/NPN 4-wire NO/NO

*(In order to ensure a Performance Level = PLe use a proximity switch type PNP NO: ref. "Interleaved proximity -> page 39).*

Measurement: Enter in this field the number of pulses/revolution (in the case of rotational sensor) or µm/pulse (linear sensor) relating to the sensor used

Verification: Enter in this field the number of pulses/revolution (in the case of rotational sensor) or µm/pulse (linear sensor) relating to the second sensor used.

Gear Ratio: This parameter is active if there are two sensors on the selected axis. This parameter allows you to enter the ratio between the two sensors. If both sensors are on the same moving parts, the ratio will be 1 otherwise the number corresponding to the report must be entered. E.g. there are an encoder and a proximity switch, and the latter is on a moving part that (due to a gear reduction ratio) rotates at twice the speed of the encoder. Therefore, this value must be set at 2.

Hysteresis (%): It represents the percentage hysteresis (the percentage is calculated from the threshold value) below which the speed change is filtered.

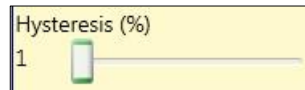

Speed 1...8: Enter in this field the maximum speed value above which the function block output (OVER) will be 0 (FALSE). If the measured speed is less than the set value, the function block output (OVER) will be 1 (TRUE). The speed value could be entered with the decimal point provided that MOSAIC M1 fw >= 4.0 or MOSAIC M1S fw >= 5.1 or MOSAIC M1S COM and MVx fw >= 2.0 were used.

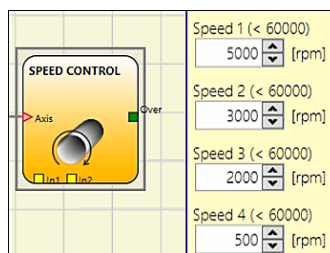

Frequency: It shows the frequencies values calculated starting from the speed thresholds fM and fm (fm is the fM threshold frequency decreased by the hysteresis set). If the displayed value is GREEN, the calculation of frequency gave a positive result.

If the displayed value is RED, it is necessary to change the parameters given in the following formulas.

1. rotational axis, rotational sensor. The frequency obtained is:

$$f[\text{Hz}] = \frac{\text{rpm}[\text{rev}/\text{min}]}{60} * \text{Resolution}[\text{pulses}/\text{rev}]$$

2. Linear axis, rotational sensor. The frequency obtained is:

$$f[\text{Hz}] = \frac{\text{speed}[\text{m}/\text{min}] * 1000}{60 * \text{pitch}[\text{mm}/\text{rev}]} * \text{Resolution}[\text{pulses}/\text{rev}]$$

3. Linear axis, linear sensor. The frequency obtained is:

$$f[\text{Hz}] = \frac{\text{speed}[\text{m}/\text{s}] * 1000}{\text{Resolution}[\mu\text{m}/\text{pulse}]}$$

4. Hysteresis. To be changed only if: fM=green; fm=red

Proximity choice:

KEY:

*f = frequency*  
*Rpm = rotational speed*  
*Resolution = measurement*  
*Speed = linear speed*  
*Pitch = sensor pitch*

WINDOW SPEED CONTROL

The Window Speed Control function block monitors the speed of a device, causing a transition from 0 (FALSE) to 1 (TRUE) of the WINDOWS output when the speed is within a prefixed range.

Parameters

Axis type: It defines the type of axis controlled by the device. It will be Linear in the case of a translation and will be rotational in the case of motion around an axis.

Sensor Type: When the previous parameter is Linear, the Sensor Type defines the type of sensor connected to the module inputs. It can be rotational (e.g. shaft encoder) or Linear (e.g. optical array). These choices allows to set other parameters explained later.

Measuring device: It defines the type of sensor(s) used. The possible choices are:

- Encoder
- Proximity
- Encoder+Proximity
- Proximity1 + Proximity2
- Encoder1 + Encoder2

Sin/Cos: Disable Analog check: only when a Sin/Cos Expansion Module is used, it is possible to disable the analog verification  $\sin^2\theta + \cos^2\theta$ , carrying out a simplified plausibility check of the Encoder signals.

**⚠ When analogue control is disabled, the diagnostic coverage decreases.**

**⚠ In addition, the safety level of the project drops from: SIL 3->SIL 2 / PL e->PL d. Please refer to chapter "Important safety instructions".**

Enable direction: (Available only when at least one Encoder input is present): when checked the DIR output is enabled on the function block. This output will be 1 (TRUE) when the axis rotates Counterclockwise and will be 0 (FALSE) when the axis rotates Clockwise

Pitch: If the Axis Type chosen was linear and rotational, this field allows you to enter the sensor pitch to obtain a conversion between sensor revolutions and distance travelled.

Proximity choice: It allows you to choose the type of proximity sensor from PNP, NPN, Normally Open (NA) and Normally Closed (NC), with 3 or 4 wires.

*(In order to ensure a Performance Level = PLe use a proximity switch type PNP NO: ref. "Interleaved proximity -> page 39).*

Measurement: Enter in this field the number of pulses/revolution (in the case of rotational sensor) or  $\mu\text{m}/\text{pulse}$  (linear sensor) relating to the sensor used.

Verification: Enter in this field the number of pulses/revolution (in the case of rotational sensor) or  $\mu\text{m}/\text{pulse}$  (linear sensor) relating to the second sensor used.

- No Proxy**
- PNP 3-wire NC
  - PNP 3-wire NO
  - NPN 3-wire NO
  - NPN 3-wire NC
  - PNP 4-wire NC/NO
  - NPN 4-wire NC/NO
  - PNP/NPN 4-wire NC/NC
  - PNP/NPN 4-wire NO/NO

Proximity choice



**Gear Ratio:** This parameter is active if there are two sensors on the selected axis. This parameter allows you to enter the ratio between the two sensors. If both sensors are on the same moving parts, the ratio will be 1 otherwise the number corresponding to the report must be entered. E.g. there are an encoder and a proximity switch, and the latter is on a moving part that (due to a gear reduction ratio) rotates at twice the speed of the encoder. Therefore, this value must be set at 2.

**Hysteresis (%):** It represents the percentage hysteresis (the percentage is calculated from the threshold value) below which the speed change is filtered.

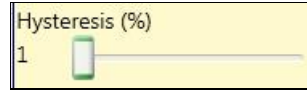

**High speed:**

Enter in this field the maximum speed value above which the output of the function block (WINDOW) will be 0 (FALSE). If the measured speed is less than the set value, the output (WINDOW) of the function block will be 1 (TRUE). The maximum speed value could be entered with the decimal point provided that MOSAIC M1 fw >= 4.0 or MOSAIC M1S fw >= 5.1 or MOSAIC M1S COM and MVx fw >= 2.0 were used.

**Low speed:**

Enter in this field the minimum speed value below which the output of the function block (WINDOW) will be 0 (FALSE). If the measured speed is more than the set value, the output (WINDOW) of the function block will be 1 (TRUE). (The minimum speed value could be entered with the decimal point provided that MOSAIC M1 fw >= 4.0 or MOSAIC M1S fw >= 5.1 or MOSAIC M1S COM and MVx fw >= 2.0 were used.

**Frequency:** It shows the frequencies values calculated starting from the speed thresholds fM and fm (fm is the fM threshold frequency decreased by the hysteresis set). If the displayed value is GREEN, the calculation of frequency gave a positive result.

If the displayed value is RED, it is necessary to change the parameters given in the following formulas.

1. Rotational axis, rotational sensor. The frequency obtained is:

$$f[\text{Hz}] = \frac{\text{rpm}[\text{rev}/\text{min}]}{60} * \text{Resolution}[\text{pulses}/\text{rev}]$$

2. Linear axis, rotational sensor. The frequency obtained is:

$$f[\text{Hz}] = \frac{\text{speed}[\text{m}/\text{min}] * 1000}{60 * \text{pitch}[\text{mm}/\text{rev}]} * \text{Resolution}[\text{pulses}/\text{rev}]$$

3. Linear axis, linear sensor. The frequency obtained is:

$$f[\text{Hz}] = \frac{\text{speed}[\text{mm}/\text{s}] * 1000}{\text{Resolution}[\mu\text{m}/\text{pulse}]}$$

4. Hysteresis. To be changed only if: fM=green; fm=red

KEY:

*f = frequency*  
*Rpm = rotational speed*  
*Resolution = measurement*  
*Speed = linear speed*  
*Pitch = sensor pitch*

STAND STILL

The StandStill function block monitors the speed of a device, causing a transition from 0 (FALSE) to 1 (TRUE) of the ZERO output when the speed is lower than a selected value.

Parameters

Axis type: It defines the type of axis controlled by the device. It will be Linear in the case of a translation and will be rotational in the case of motion around an axis.

Sensor Type: When that the previous parameter is Linear, the Sensor Type defines the type of sensor connected to the module inputs. It can be rotational (e.g. shaft encoder) or Linear (e.g. optical array). This choice allows to define the following parameters.

Measuring device: It defines the type of sensor(s) used. The possible choices are:

- Encoder
- Proximity
- Encoder+Proximity
- Proximity1 + Proximity2
- Encoder1 + Encoder2

Sin/Cos: Disable Analog check: only when a Sin/Cos Module is used, it is possible to disable the analog verification  $\sin^2\theta + \cos^2\theta$ , carrying out a simplified plausibility check of the Encoder signals.

**When analogue control is disabled, the diagnostic coverage decreases.**

**In addition, the safety level of the project drops from: SIL 3->SIL 2 / PL e->PL d. Please refer to chapter "Important safety instructions".**

Pitch: If the Axis Type chosen was linear and rotational, this field allows you to enter the sensor pitch to obtain a conversion between sensor revolutions and distance travelled.

Proximity choice: It allows you to choose the type of proximity sensor from PNP, NPN, Normally Open (NO) and Normally Closed (NC), with 3 or 4 wires.

*(In order to ensure a Performance Level = PLe use a proximity switch type PNP NO: ref. "Interleaved proximity -> page 25).*

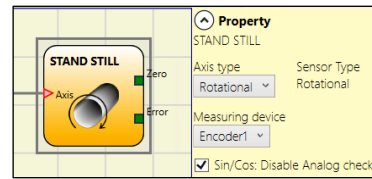
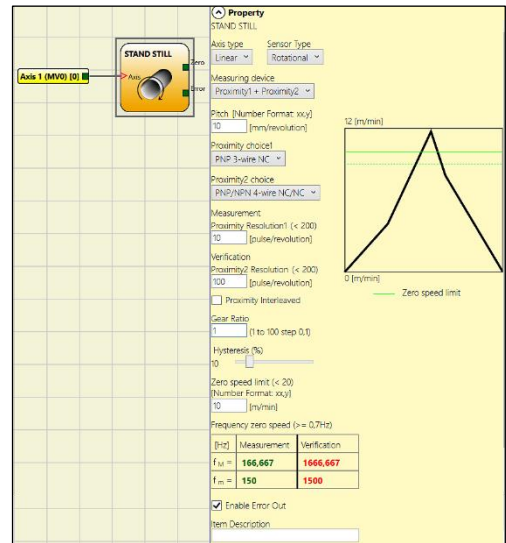

- No Proxy**
- PNP 3-wire NC
  - PNP 3-wire NO
  - NPN 3-wire NO
  - NPN 3-wire NC
  - PNP 4-wire NC/NO
  - NPN 4-wire NC/NO
  - PNP/NPN 4-wire NC/NC
  - PNP/NPN 4-wire NO/NO

Proximity choice

Measurement: Enter in this field the number of pulses/revolution (in the case of rotational sensor) or µm/pulse (linear sensor) relating to the sensor used

Verification: Enter in this field the number of pulses/revolution (in the case of rotational sensor) or µm/pulse (linear sensor) relating to the second sensor used.

Gear Ratio: This parameter is active if there are two sensors on the selected axis. This parameter allows you to enter the ratio between the two sensors. If both sensors are on the same moving parts, the ratio will be 1 otherwise the number corresponding to the report must be entered. E.g. there are an encoder and a proximity switch, and the latter is on a moving part that (due to a gear reduction ratio) rotates at twice the speed of the encoder. Therefore, this value must be set at 2.

Hysteresis (%): It represents the percentage hysteresis (the percentage is calculated from the threshold value) below which the speed change is filtered.

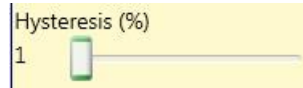

Zero speed limit:

Enter in this field the maximum speed value above which the output of the function block (ZERO) will be 0 (FALSE). If the measured speed is less than the set value, the output (ZERO) of the function block will be 1 (TRUE).

Frequency zero speed: It shows the maximum calculated frequency values fM and fm (fm is the fM threshold frequency decreased by the hysteresis set). If the displayed value is GREEN, the calculation of frequency gave a positive result.

If the displayed value is RED, it is necessary to change the parameters given in the following formulas.

1. rotational axis, rotational sensor. The frequency obtained is:

$$f[\text{Hz}] = \frac{\text{rpm}[\text{rev}/\text{min}] * \text{Resolution}[\text{pulses}/\text{rev}]}{60}$$

2. Linear axis, rotational sensor. The frequency obtained is:

$$f[\text{Hz}] = \frac{\text{speed}[\text{m}/\text{min}] * 1000}{60 * \text{pitch}[\text{mm}/\text{rev}]} * \text{Re solution}[\text{pulses}/\text{rev}]$$

3. Linear axis, linear sensor. The frequency obtained is:

$$f[\text{Hz}] = \frac{\text{speed}[\text{mm}/\text{s}] * 1000}{\text{Resolution}[\mu\text{m}/\text{pulse}]}$$

4. Hysteresis. To be changed only if: fM=green; fm=red

KEY:

*f* = frequency  
*Rpm* = rotational speed  
*Resolution* = measurement  
*Speed* = linear speed  
*Pitch* = sensor pitch

STAND STILL AND SPEED CONTROL

The StandStill and Speed Control function block monitors the speed of a device, causing the transition from 0 (FALSE) to 1 (TRUE) of the ZERO output when the speed is lower than a selected output. In addition a transition from 0 (FALSE) to 1 (TRUE) of the OVER output is generated when the measured speed exceeds a predetermined threshold.

Parameters

**Axis type:** It defines the type of axis controlled by the device. It will be Linear in the case of a translation and will be rotational in the case of motion around an axis.

**Sensor Type:** In the event that the previous parameter is Linear, the Sensor Type defines the type of sensor connected to the module inputs. It can be rotational (e.g. shaft encoder) or Linear (e.g. optical array). This choice allows to define the following parameters.

**Measuring device:** It defines the type of sensor(s) used. The possible choices are:

- Encoder
- Proximity
- Encoder+Proximity
- Proximity1+ Proximity2
- Encoder1+ Encoder2

**Sin/Cos: Disable Analog check:** only when a Sin/Cos Encoder is used, it is possible to disable the analog verification  $\sin^2\theta + \cos^2\theta$ , carrying out a simplified plausibility check of the Encoder signals.

**⚠ When analogue control is disabled, the diagnostic coverage decreases.**

**⚠ In addition, the safety level of the project drops from: SIL 3->SIL 2 / PL e->PL d. Please refer to chapter "Important safety instructions".**

**Enable direction:** (Available only when at least one Encoder input is present): when checked, the DIR output is enabled on the function block. This output will be 1 (TRUE) when the axis rotates Counterclockwise and will be 0 (FALSE) when the axis rotates Clockwise.

**Direction decision:** It defines the direction of rotation for which the set thresholds are made active. The possible choices are:

- Bidirectional
- Clockwise
- Counterclockwise

If Bidirectional is selected, the excess of the set threshold is detected whether the axis rotates clockwise or counterclockwise. Selecting Clockwise or Counterclockwise, this is detected only when the axis rotates in the selected direction.



Example of CLOCKWISE axis rotation

2 threshold settings

In1	Threshold no.
0	Speed 1
1	Speed 2

Up to 4 threshold settings

In2	In1	Threshold no.
0	0	Speed 1
0	1	Speed 2
1	0	Speed 3
1	1	Speed 4

Threshold number: It allows you to enter the number of thresholds for the maximum value of speed. Changing this value will increase/decrease the number of thresholds that can be entered from:

- 1 to 8 with MOSAIC M1 fw >= 4.0, MOSAIC M1S fw >=5.1 and MVx fw >= 2.0, with MOSAIC M1S COM and MVx fw >= 2.0
- 1 to 4 with MOSAIC M1 fw <4.0 or MOSAIC M1S< 5.1 or MVx fw < 2.0.

In the case of thresholds greater than 1, the input pins for the selection of the specific threshold will appear in the lower part of the function block. Let the user to choose which threshold has to be enabled.

**Up to 8 threshold settings**

In3	In2	In1	Threshold no.
0	0	0	Speed 1
0	0	1	Speed 2
0	1	0	Speed 3
0	1	1	Speed 4
1	0	0	Speed 5
1	0	1	Speed 6
1	1	0	Speed 7
1	1	1	Speed 8

Pitch: If the Axis Type chosen was linear and rotational, this field allows you to enter the sensor pitch to obtain a conversion between sensor revolutions and distance travelled.

Proximity choice: It allows you to choose the type of proximity sensor from PNP, NPN, Normally Open (NA) and Normally Closed (NC), with 3 or 4 wires.

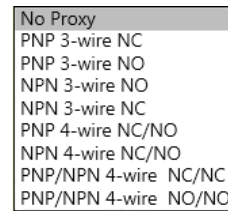

Proximity choice:

*(In order to ensure a Performance Level = PLe use a proximity switch type PNP NO: ref. "Interleaved proximity -> page 39).*

Measurement: Enter in this field the number of pulses/revolution (in the case of rotational sensor) or µm/pulse (linear sensor) relating to the sensor used.

Verification: Enter in this field the number of pulses/revolution (in the case of rotational sensor) or µm/pulse (linear sensor) relating to the second sensor used.

Gear Ratio: This parameter is active if there are two sensors on the selected axis. This parameter allows you to enter the ratio between the two sensors. If both sensors are on the same moving parts, the ratio will be 1 otherwise the number corresponding to the report must be entered. E.g. there are an encoder and a proximity switch, and the latter is on a moving part that (due to a gear reduction ratio) rotates at twice the speed of the encoder. Therefore, this value must be set at 2.

Hysteresis (%): It represents the percentage hysteresis (the percentage is calculated from the threshold value) below which the speed change is filtered.

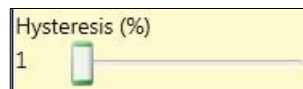

Zero speed limit:

Enter in this field the maximum speed value above which the output of the function block (ZERO) will be 0 (FALSE). If the measured speed is less than the set value, the output (ZERO) of the function block will be 1 (TRUE).

**Speed 1...8:** Enter in this field the maximum speed value above which the function block output (OVER) will be 0 (FALSE). If the measured speed is less than the set value, the function block output (OVER) will be 1 (TRUE). The speed value could be entered with the decimal point provided that MOSAIC M1 fw >= 4.0 or MOSAIC M1S fw >= 5.1 or MOSAIC M1S COM and MVx fw >= 2.0 were used.

Frequency zero speed/Frequency1/ Frequency2: It shows the maximum calculated frequency values  $f_M$  and  $f_m$  ( $f_m$  is the  $f_M$  threshold frequency decreased by the hysteresis set). If the displayed value is GREEN, the calculation of frequency gave a positive result.

If the displayed value is RED, it is necessary to change the parameters given in the following formulas.

1. rotational axis, rotational sensor. The frequency obtained is:

$$f[\text{Hz}] = \frac{\text{rpm}[\text{rev}/\text{min}]}{60} * \text{Resolution}[\text{pulses}/\text{rev}]$$

2. Linear axis, rotational sensor. The frequency obtained is:

$$f[\text{Hz}] = \frac{\text{speed}[\text{m}/\text{min}] * 1000}{60 * \text{pitch}[\text{mm}/\text{rev}]} * \text{Resolution}[\text{pulses}/\text{rev}]$$

3. Linear axis, linear sensor. The frequency obtained is:

$$f[\text{Hz}] = \frac{\text{speed}[\text{mm}/\text{s}] * 1000}{\text{Resolution}[\mu\text{m}/\text{pulse}]}$$

4. Hysteresis. To be changed only if:  $f_M$ =green;  $f_m$ =red

KEY:

$f$  = frequency  
*Rpm* = rotational speed  
*Resolution* = measurement  
*Speed* = linear speed  
*Pitch* = sensor pitch

## ANALOG INPUT TYPE FUNCTION BLOCKS

### ANALOG INPUT (4 inputs each MA4 module, 2 inputs each MA2 module)

The functional block “Analog Input” allows the selection of which types of analog sensor that will be used (0...20mA; 4...20mA; 0...10V) together with the parameters that will set the acquisition. It allows also the configuration of two simple threshold comparators or one window comparator.

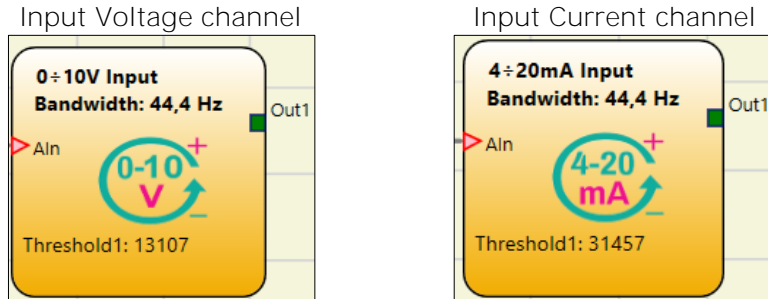

### Parameters

- Input type
  - Single
  - Redundant
    - Sensors coherence
    - Incoherence calculation mode
    - Consolidation
- Measurement unit
- Scale: minimum value
- Scale: maximum value
- 0...20 mA Input
- 0...10 V Input
- Window comparator
- Enable threshold1
- Enable threshold2
- Hysteresis
- Sample per second
- Current limit: minimum current
- Current limit: maximum current
- Sensor anomaly
  - Saturated 0 mA
  - Saturated 25 mA
- Analog Output
- Enable Error Out

**⚠** If wrong parameters are attributed (eg. scale values not corresponding to those used by sensor), the functionality of the MA2/MA4 module is compromised.

**⚠** Perform a complete system TEST (see page 127).

Detailed description

Input type

It defines the inputs type of the MA2/MA4 module channels described below.

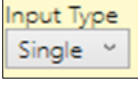
**Single** 

A single sensor is connected to one channel from 1 to 4.

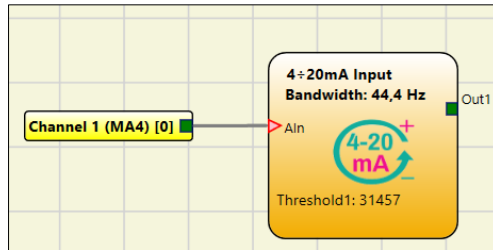

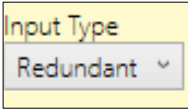
**Redundant** 

A pair of sensors is connected to two adjacent channels (1-2 or 3-4). The sensor pair readings are processed by a single analog block.

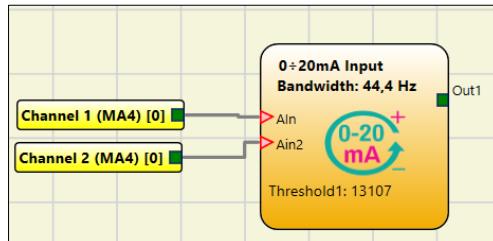

In the table below are summarized the channels allowable connections (the Not-connected cases are excluded on purpose).

Channel	Ch. 1	Ch. 2	Ch. 3	Ch. 4
Input Type	Single	Single	Single	Single
	Redundant	Redundant	Single	Single
	Single	Single	Redundant	Redundant
	Redundant	Redundant	Redundant	Redundant



In case of Input Type -> Redundant, three further options will be enabled:

1. Sensors coherence
2. Incoherence calculation mode
3. Consolidation

**Sensors coherence**

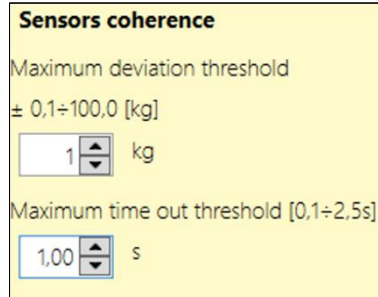

The measurement results of the two channels in redundant configuration are unlikely to be exactly the same (even with equal sensors) due to the tolerances in the signal chain. The tolerable difference between the channels can be set-up in the option Sensors Coherence.

The following parameters are provided to compensate for permissible differences between readings of identical sensors.

- Maximum deviation threshold: Maximum tolerable difference between the measurements of the two sensors in the unit defined in the parameter Measurement unit.
- Maximum timeout threshold: maximum time to exceed the gap in seconds.

For additional explanation see the following diagram.

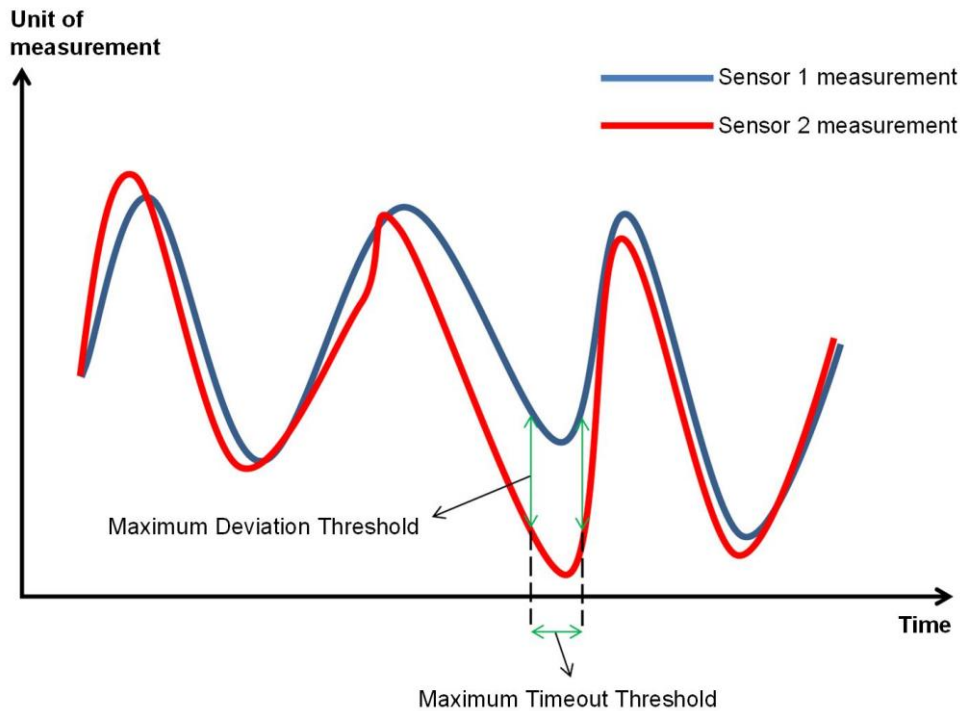

**Incoherence calculation mode: equal sensors**

Select Equal sensors if the sensors to be used are identical i.e. they have the same scale. No additional configuration is required.

**Incoherence calculation mode**

Equal sensors

Different sensors

The following parameter is provided to define whether the sensors are the same or different.

Equal sensors: The pair of sensors have the same characteristics and no parameters need no further configuration.  
 For additional explanation see the following diagram.

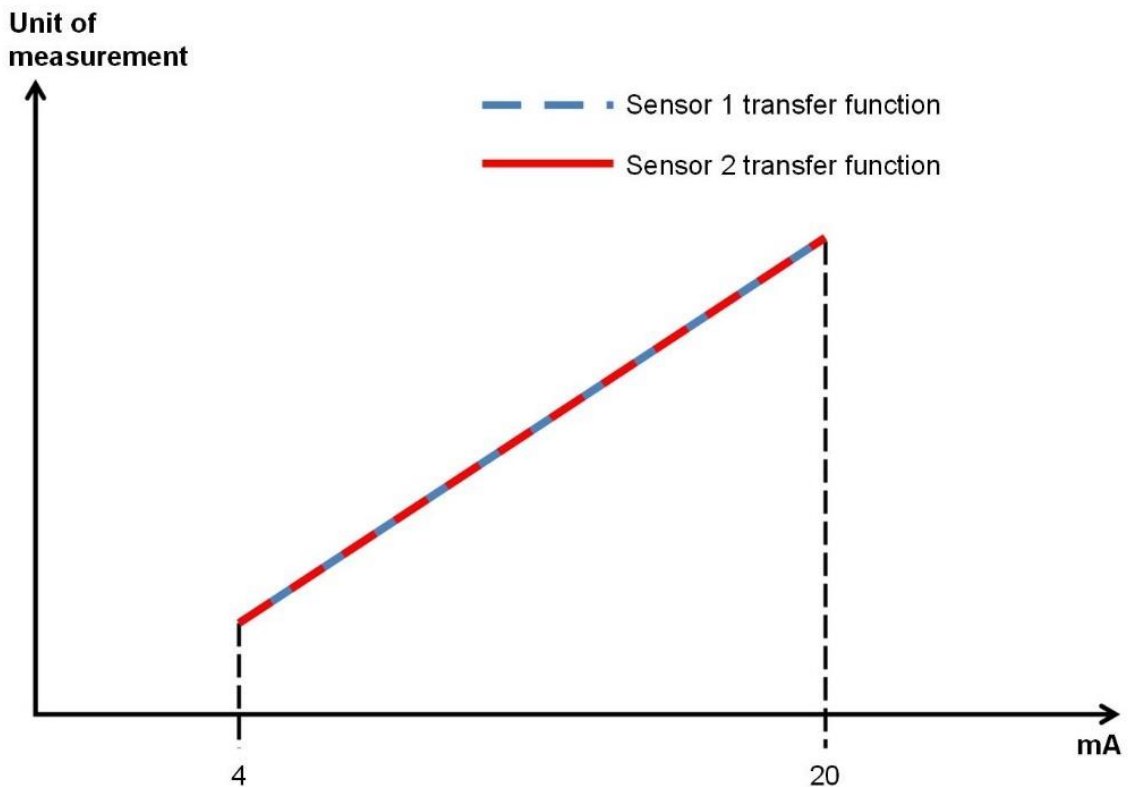

**Incoherence calculation mode: different sensors**

The two sensors used in the redundant configuration must provide the same reading in units but they can have different scaling factors.

Incoherence calculation mode		
<input type="radio"/>	Equal sensors	
<input checked="" type="radio"/>	Different sensors	
Scale		
0 mA (0V):	<input type="text" value="0"/>	Kg
20mA (10V):	<input type="text" value="0"/>	Kg
Slope	<input type="text" value="0"/>	Kg/V
Offset	<input type="text" value="0"/>	Kg

The following parameter is provided to define whether the sensors are the same or different.

Different sensors: the pair of sensors used are not identical. The box Scale is displayed. The values you enter in this box are used for scaling of the second sensor and calculation of the differences between the two sensors. The MA2/MA4 module will adapt signal conversion accordingly i.e. the scale of the second sensor will adapt automatically to the scale of the first sensor.

For additional explanation see the diagram following.

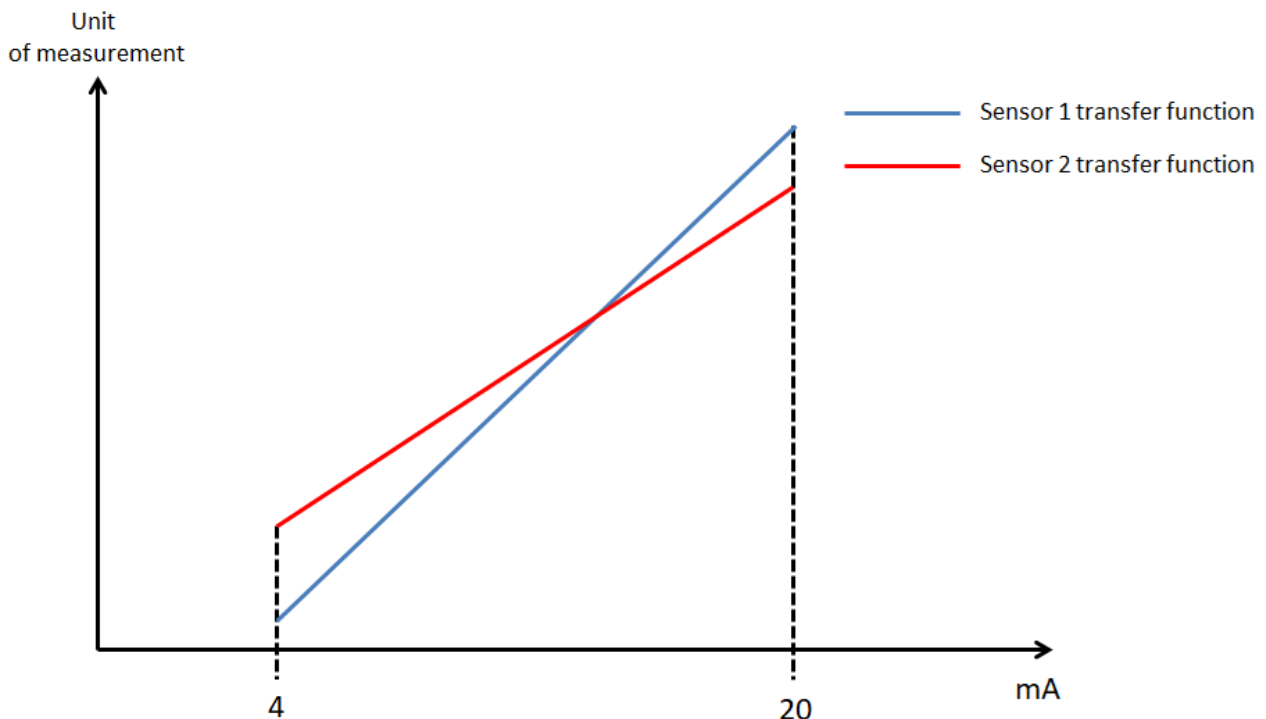

**Input Type Redundant: Consolidation**

If you select Redundant as Input type, you must configure the Consolidation parameter which specifies the measurement value to be used.

Select the measurement values to be used by MA2/MA4 comparators and sent as analog data to MOSAIC M1S, MOSAIC M1S COM controller:

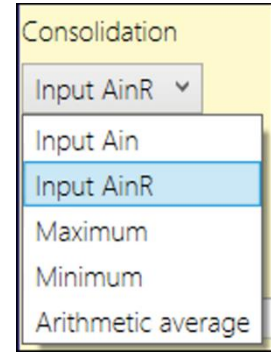

- Input Ain: Use the values supplied by the connected Channel.
- AinR: Use the values supplied by the connected Channel.
- Maximum: Use the maximum value supplied by channels 1 or 2, whichever is greater.
- Minimum: Use the minimum value supplied by channels 1 or 2, whichever is less.
- Arithmetic average: Use the arithmetic mean of the values supplied by channels 1 and 2.

**Measurement unit: Scale and type of input**

You must specify the unit (e.g. Celsius degree, Bar, kg, m/s) and the scale of the measurement. The MA2/MA4 module will calculate the relationship between these values and the corresponding measured current or voltage values (scaling) based on the condition that the sensor has a linear characteristic.

- Scale, minimum value: It is the lowest value in units corresponding to the minimum output value of the sensor (4 mA for a 4÷20 mA sensor, 0 mA for a 0÷20 mA sensor and 0 V for a 0÷10 Vdc sensor).
- Scale, maximum value: it is the highest value in units corresponding to the maximum output value of the sensor (20 mA for a 0/4÷20 mA sensor and 10 Vdc for a 0÷10 Vdc sensor).

➔ MSD assumes that the sensors have a linear transfer function and, as a consequence, automatically computes the slope and the offset of the transfer function on the basis of the values entered by the user.

⚠ Do not use a configuration of the function block as 0÷20 mA or 0÷10 V input for safety purposes. If you use a configuration of the function block as 0÷20 mA or 0÷10 V input for non safety purposes, implement all measures required to avoid unintended equipment operation and any other hazard.

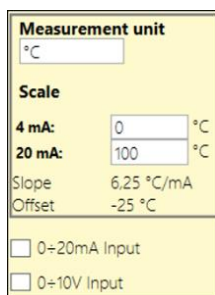

Input type: 4÷20mA -> no selection

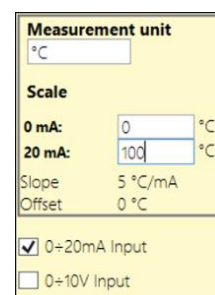

Input type: 0÷20mA -> 0÷20mA Input selected

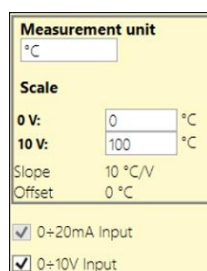

Input type: 0÷10V -> 0÷10V Input selected

**Reading analysis: Window comparator**

If you activate the option Window comparator, the output Out1 is added to the graphical representation of the function block and a number of additional parameters are displayed.

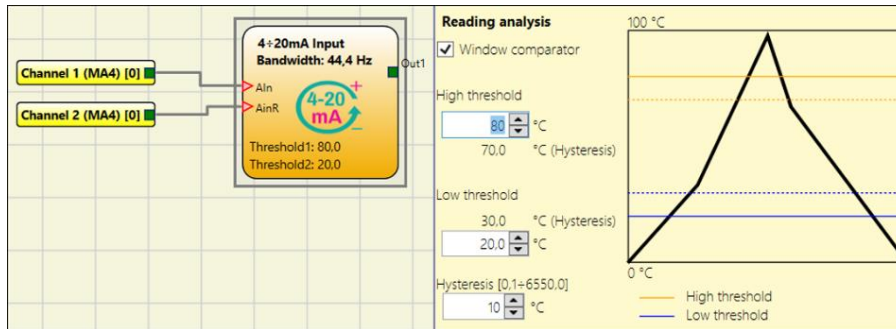

The following parameters are provided to define the behavior of the Window comparator:

High threshold: is the maximum value of the range set for the window.

Low threshold: is the minimum value of the range set for the window.

Hysteresis: is the hysteresis value for the window.

The output state of the window comparator depends on the value of the division and on its actual logic state. There are two possible states:

- ➔ **OUT OF WINDOW:** the output of the comparator is a logical value 0 If the state of the Window comparator is Out of Window, the output of the Window comparator is FALSE.
- ➔ **IN WINDOW:** the output of the comparator is a logical value 1 If the state of the Window comparator is In Window, the output of the Window comparator is TRUE.

The following figure and table exemplify the states of the Window comparator:

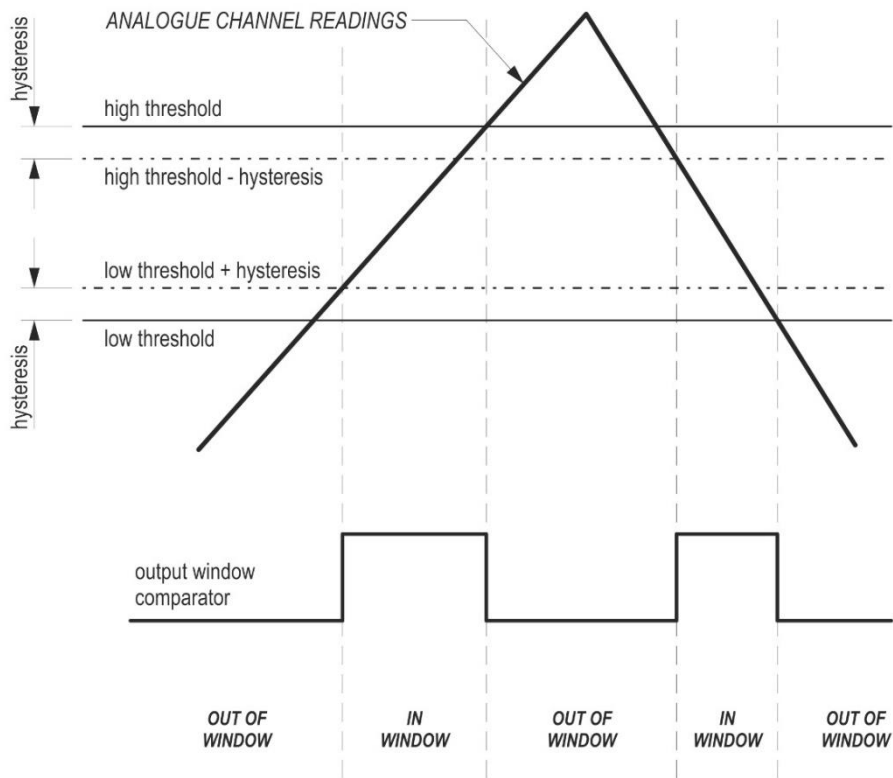
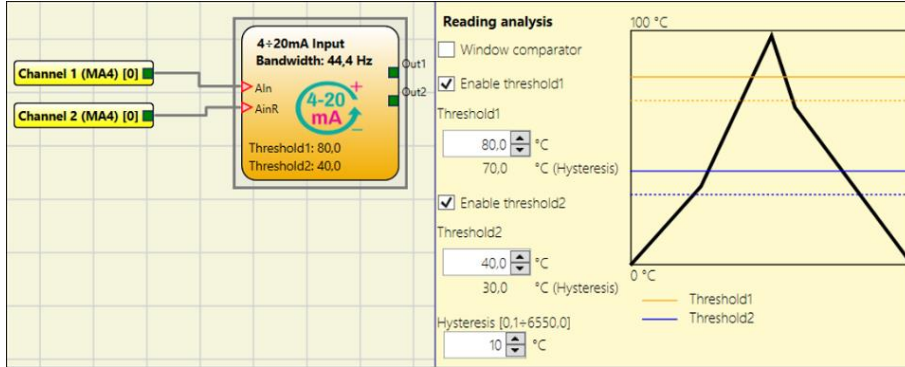

Figure 98 - Example of window comparator behavior

Measurement value (A)	Current state of window comparator	Next state of window comparator
(A) < Low threshold value + hysteresis	OUT OF WINDOW	OUT OF WINDOW
(A) > High threshold	OUT OF WINDOW	OUT OF WINDOW
(A) >= High threshold value - hysteresis	OUT OF WINDOW	OUT OF WINDOW
(A) <= Low threshold value	OUT OF WINDOW	OUT OF WINDOW
(A) < High threshold value - hysteresis	OUT OF WINDOW	IN WINDOW
(A) > Low threshold value	OUT OF WINDOW	IN WINDOW
(A) < High threshold value	IN WINDOW	IN WINDOW
(A) > Low threshold value + hysteresis	IN WINDOW	IN WINDOW

**Reading analysis: Enable threshold1 / threshold2**

If you activate the options Enable threshold1 and/or Enable threshold2, the output Out1 and/or Out2 are added to the graphical representation of the function block and a number of additional parameters are displayed.



The following parameters are provided to define the behavior of the Threshold comparator:

- Threshold1 / threshold2: is the value of the threshold.
- Hysteresis: is the hysteresis value

The following figure and table exemplify the states of the Enable threshold:

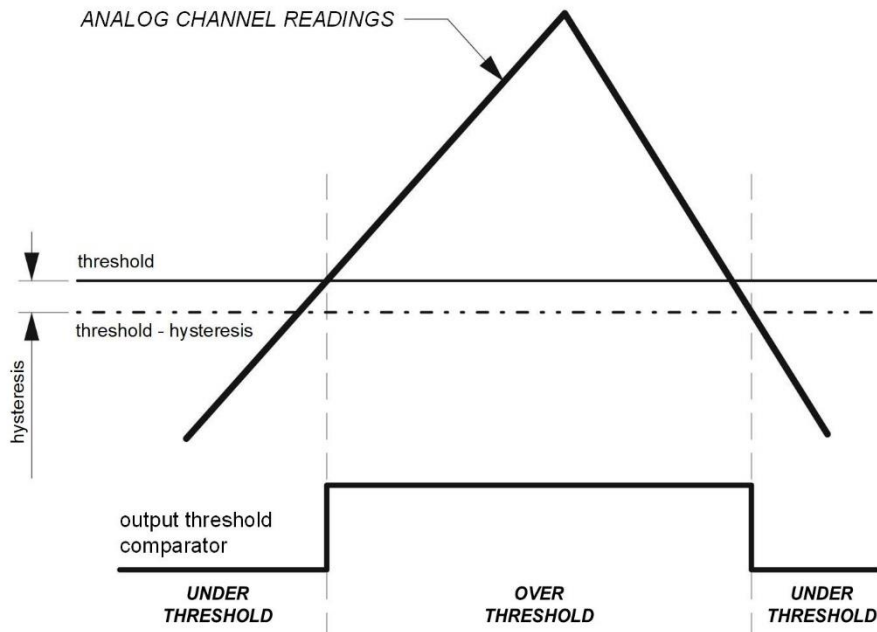

Figure 99 - Example of Enable threshold behavior

Measurement value (A)	Current state of threshold comparator	Next state of threshold comparator
$(A) < \text{Threshold value} - \text{hysteresis}$	UNDER THRESHOLD	UNDER THRESHOLD
$(A) \leq \text{Threshold value}$	UNDER THRESHOLD	UNDER THRESHOLD
$(A) > \text{Threshold value}$	UNDER THRESHOLD	OVER THRESHOLD
$(A) < \text{Threshold value} - \text{hysteresis}$	OVER THRESHOLD	OVER THRESHOLD
$(A) < \text{Threshold value} - \text{hysteresis}$	OVER THRESHOLD	UNDER THRESHOLD

**Samples per second**

Let the user to choose the number of sampling per second of the Analog to Digital Sigma Delta converter. A low value would have better performance in terms of noise while an high value would have better performance in terms of response speed. The value 50 and 60 enhance line filter rejection.

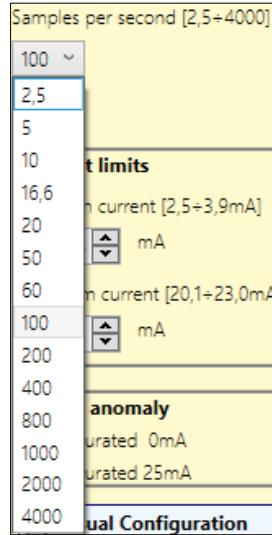
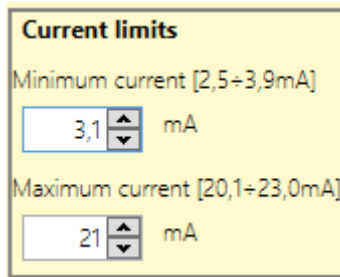

Figure 100 - List of samples per second possible values

**Current/Voltage limits: minimum current and maximum current/voltage**

**Current sensors: current limits**



The user can set the range of valid measurement values setting a minimum current and a maximum current.

- Minimum current values: range from 2.5 mA to 3.9 mA
- Maximum current values: range from 20.1 mA to 23 mA.

If the measurement values are under the minimum value or over the maximum value a diagnosis is set.

The following table summarize MA2/MA4 module behaviour as a function of measurement values.

Measurement value (A)	Diagnostic
(A) < Minimum current limit	YES
(A) > Maximum current limit	YES
Minimum current limit < (A) < Maximum current limit	NO

English



**Voltage sensors: voltage limits**

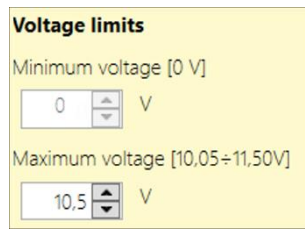

The user can set the range of valid measurement values by set a maximum voltage. If the measurement values are over the maximum value a diagnosis is set. The allowable maximum voltage values range from 10,05 V to 11,5 V. The following table summarize MA2/MA4 module behaviour as a function of measurement values.

Measurement value (A)	Diagnostic
(A) < Minimum voltage limit	NO
(A) > Maximum voltage limit	YES
Minimum voltage limit < (A) < Maximum voltage limit	NO

**Sensor anomaly: measure saturated at 0 mA or 25 mA**

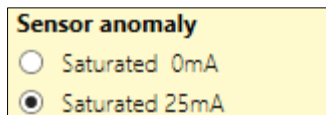

This option let the user to choose which value MA2/MA4 will force to the measurement when a sensor anomaly is detected.

The list of sensor anomalies are reported below:

- Disconnected cable (only for 4mA/20mA sensors)
- Isolated channel power supply overload
- Isolated channel input overload

**Analog Output**

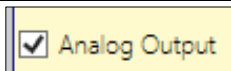

When this flag is checked the raw value of the measurements are available to MSD. This is highlighted on input block by a light green square near the label "Analog".

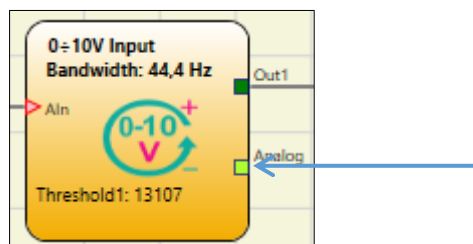

Enable Error Out  Enable Error Out

When this flag is checked the a digital signal is available to indicate an error when an anomaly on a sensor is detected. This is highlighted on input block by a dark green square near the label “Error”.

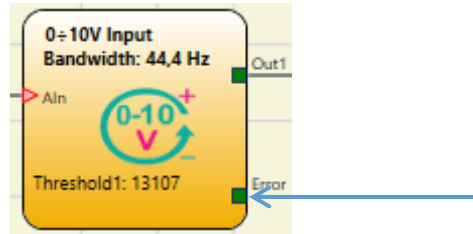

The following table shown the possible values of the “Error” signal.

Anomaly	“Error” Value
Present	1 (TRUE)
Not present	0 (FALSE)

**ANALOG DIVISION (4 inputs each MA4 module, 2 inputs each MA2 module)**

The function block ANALOG DIVISION allows the arithmetic division of the values of two inputs. The inputs can be single or redundant.

ANALOG DIVISION allows also the configuration of one THRESHOLD COMPARATOR (or one WINDOW COMPARATOR) and a WARNING COMPARATOR.

Voltage Input

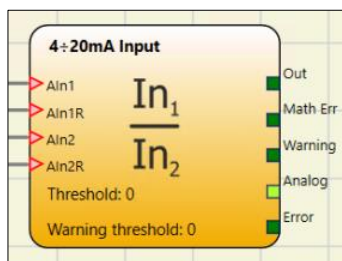

Current Input

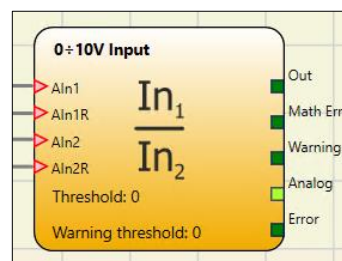

## Parameters

- Input type
  - Single
  - Redundant
    - Sensors coherence
    - Incoherence calculation mode
    - Consolidation
- Measurement unit
- Scale: minimum value
- Scale: maximum value
- 0...20 mA Input
- 0...10 V Input
- Window comparator
- Enable threshold
- Warning enable
- Hysteresis
- Sample per second
- Current limit: minimum current
- Current limit: maximum current
- Division Anomaly: division saturated at 0 or 200000
- Analog Output
- Enable Error Out

**Property**  
ANALOG DIVISION

Input Type  
Single

Measurement unit	
°C	

Input 1: Scale	Input 2: Scale
0 V: 0 °C	0 V: 0 °C
10 V: 0 °C	10 V: 0 °C
Slope: 0 °C/V	Slope: 0 °C/V
Offset: 0 °C	Offset: 0 °C

Samples per second [2,5÷4000]

Input 1: 100      Input 2: 100

Input 1: Voltage limits	Input 2: Voltage limits
Minimum voltage [0 V]: 0 V	Minimum voltage [0 V]: 0 V
Maximum voltage [10,05÷11,50V]: 10,5 V	Maximum voltage [10,05÷11,50V]: 10,5 V

0=20mA Input  
 0=10V Input

**Division anomaly**  
 Saturated: 0  
 Saturated: 200000

**Division analysis**

Window comparator  
 Enable threshold  
 Threshold: 50  
 45,0000 Hysteresis  
 Hysteresis [0,1÷100,0] %: 10,0

Warning Enable  
 Warning: lower limit  
 Warning threshold: 110,0000  
 Hysteresis: 100

Analog Output  
 Enable Error Out

Item Description

Input Type  
Single

**Single**

The measurement values of two single channels are divided.

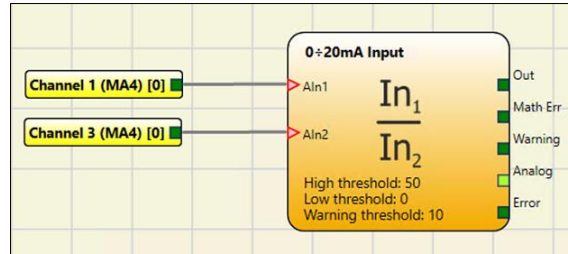

Input Type  
Redundant

**Redundant**

The measurement values of two pairs of sensors configured as redundant are divided. The following illustration shows this configuration (the suffix R identifies the redundant input channel).

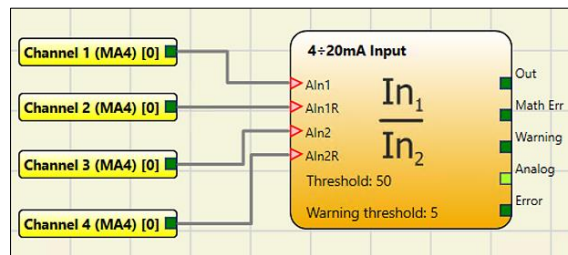

The following table summarizes the possible divisions:

Division	Channel 1 / Channel 2
	Channel 3 / Channel 4
	Channel 1,2 / Channel 3,4

**Maximum deviation threshold / Maximum timeout threshold**

In case of Input Type -> Redundant, three further options will be enabled:

1. Sensors coherence
2. Incoherence calculation mode
3. Consolidation

**Sensors coherence**

<b>Redundant: Sensors coherence</b>	
<b>Input 1:</b> Maximum deviation threshold ± 0,1÷100,0 []	<b>Input 2:</b> Maximum deviation threshold ± 0,1÷100,0 []
<input type="text" value="1"/>	<input type="text" value="1"/>
<b>Input 1</b> Maximum time out threshold [0,1÷2,5s]	<b>Input 2</b> Maximum time out threshold [0,1÷2,5s]
<input type="text" value="0,1"/> s	<input type="text" value="0,1"/> s

The measurement results of the two channels in redundant configuration are unlikely to be exactly the same (even with equal sensors) due to the tolerances in the signal chain. The tolerable difference between the channels can be set-up in the option Sensors Coherence.

The following parameters are provided to compensate for permissible differences between readings of identical sensors.

- Maximum deviation threshold: Maximum tolerable difference between the measurements of the two sensors in the unit defined in the parameter Measurement unit.
- Maximum timeout threshold: maximum time to exceed the gap in seconds.

For additional explanation see the following diagram.

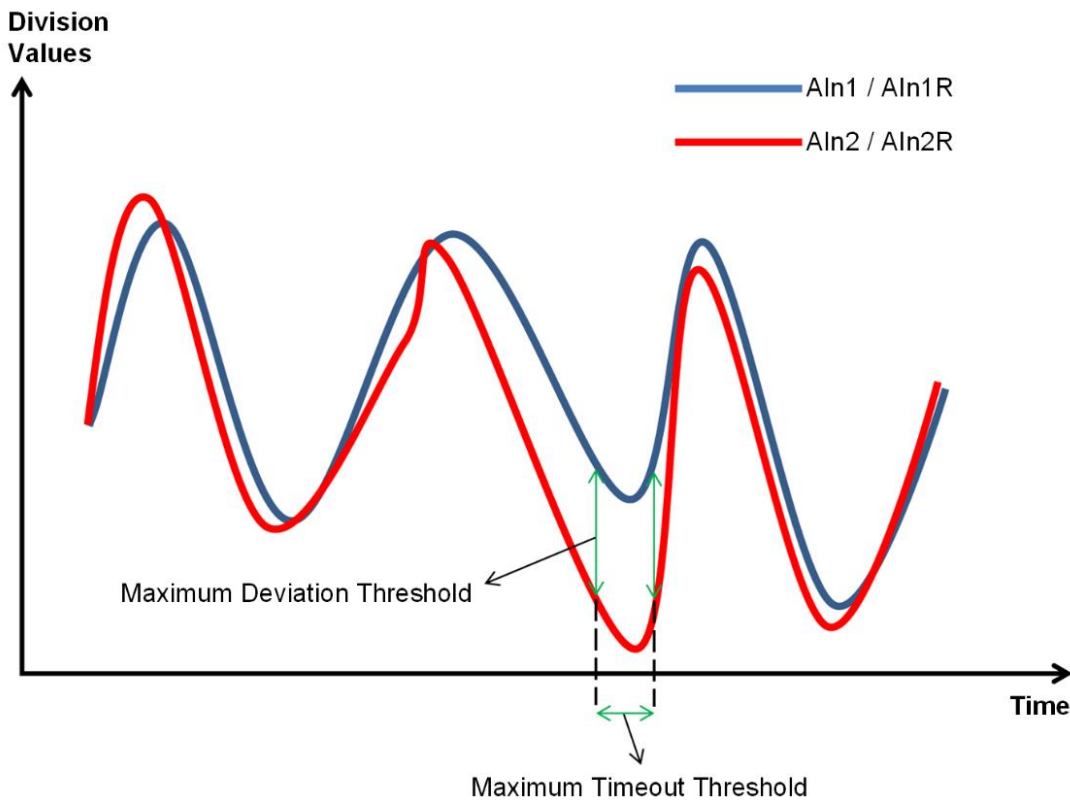

**Incoherence calculation mode: equal sensors**

Select Equal sensors if the sensors to be used are identical i.e. they have the same scale. No additional configuration is required.

Incoherence calculation mode	
<b>Input 1</b>	<b>Input 2</b>
<input checked="" type="radio"/> Equal sensors	<input checked="" type="radio"/> Equal sensors
<input type="radio"/> Different sensors	<input type="radio"/> Different sensors

The following parameter is provided to define whether the sensors are the same or different.

Equal sensors: The pair of sensors have the same characteristics and no parameters need no further configuration.  
For additional explanation see the diagram following.

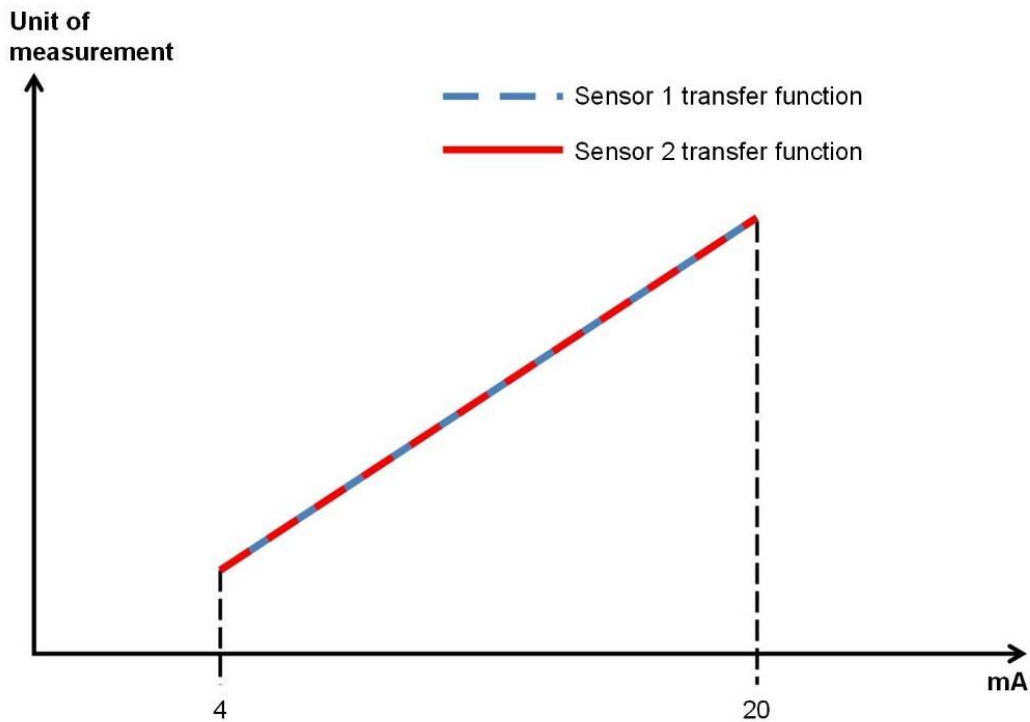

**Incoherence calculation mode: different sensors**

The two sensors used in the redundant configuration must provide the same reading in units but they can have different scaling factors.

Incoherence calculation mode			
<b>Input 1</b>		<b>Input 2</b>	
<input type="radio"/> Equal sensors		<input type="radio"/> Equal sensors	
<input checked="" type="radio"/> Different sensors		<input checked="" type="radio"/> Different sensors	
<b>Input 1: Scale</b>		<b>Input 2: Scale</b>	
4 mA:	<input type="text" value="0"/>	4 mA:	<input type="text" value="0"/>
20 mA:	<input type="text" value="0"/>	20 mA:	<input type="text" value="0"/>
Slope	0 /mA	Slope	0 /mA
Offset	0	Offset	0

The following parameter is provided to define whether the sensors are the same or different.

Different sensors: the pair of sensors used are not identical. The box Scale is displayed. The values you enter in this box are used for scaling of the second sensor and calculation of the differences between the two sensors. The MA2/MA4 module will adapt signal conversion accordingly i.e. the scale of the second sensor will adapt automatically to the scale of the first sensor.

For additional explanation see the diagram following.

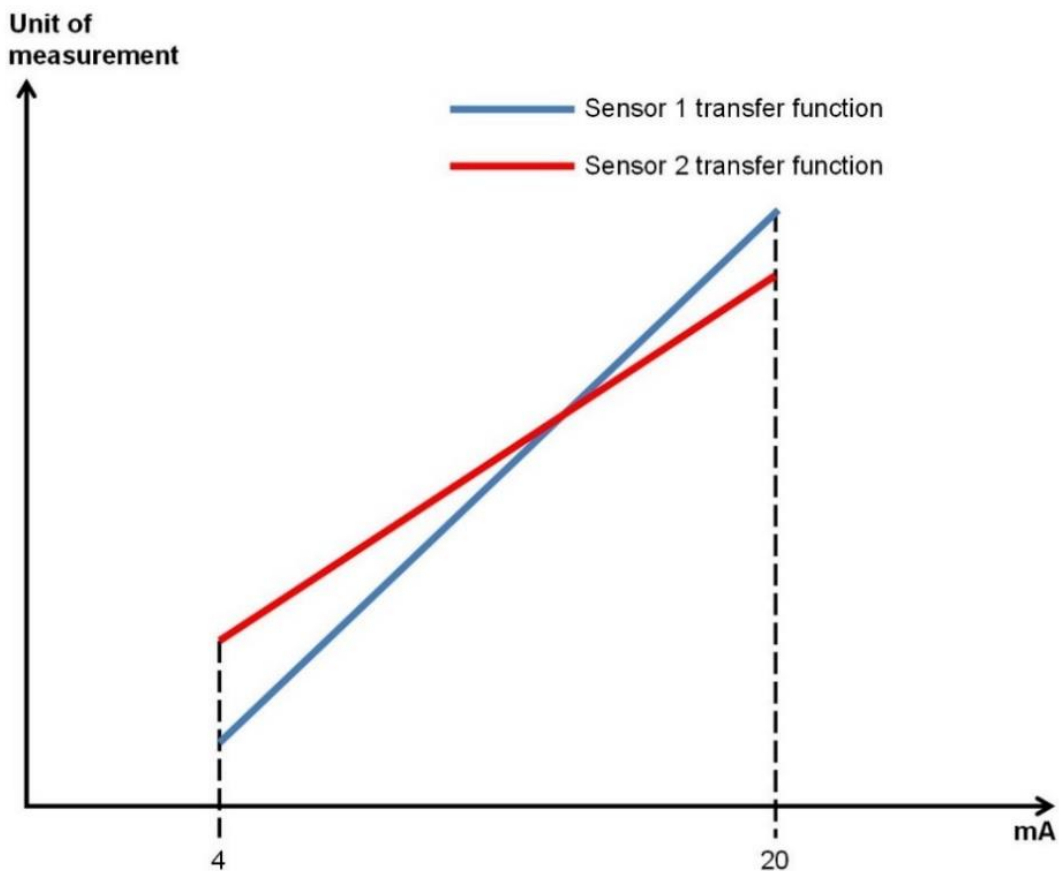

**Input Type Redundant: Consolidation**

If you select Redundant as Input type, you must configure the Consolidation parameter which specifies the measurement value to be used.

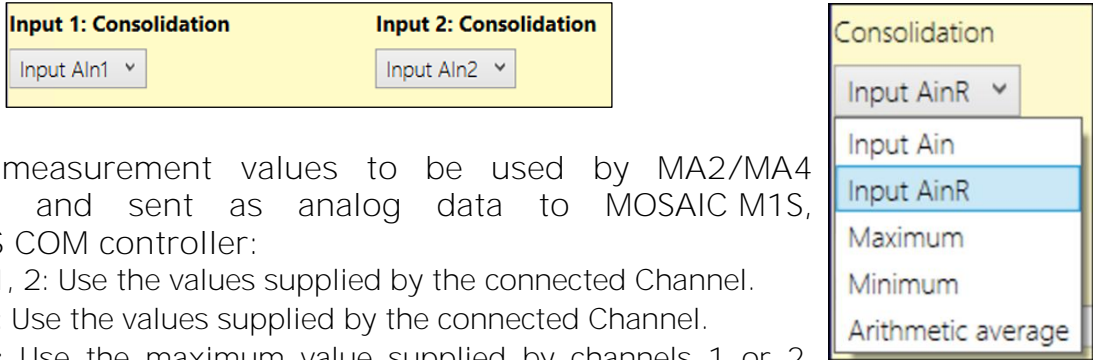

Select the measurement values to be used by MA2/MA4 comparators and sent as analog data to MOSAIC M1S, MOSAIC M1S COM controller:

- Input Ain1, 2: Use the values supplied by the connected Channel.
- Ain1R, 2R: Use the values supplied by the connected Channel.
- Maximum: Use the maximum value supplied by channels 1 or 2, whichever is greater.
- Minimum: Use the minimum value supplied by channels 1 or 2, whichever is less.
- Arithmetic average: Use the arithmetic mean of the values supplied by channels 1 and 2.

**Measurement unit: Scale and type of input**

You must specify the unit (e.g. Celsius degree, Bar, kg, m/s) and the scale of the measurement. The MA2/MA4 module will calculate the relationship between these values and the corresponding measured current or voltage values (scaling) based on the condition that the sensor has a linear characteristic.

- Scale, minimum value: It is the lowest value in units corresponding to the minimum output value of the sensor (4 mA for a 4÷20 mA sensor, 0 mA for a 0÷20 mA sensor and 0 V for a 0÷10 Vdc sensor).
- Scale, maximum value: it is the highest value in units corresponding to the maximum output value of the sensor (20 mA for a 0/4÷20 mA sensor and 10 Vdc for a 0÷10 Vdc sensor).

➔ MSD assumes that the sensors have a linear transfer function and, as a consequence, automatically computes the slope and the offset of the transfer function on the basis of the values entered by the user.

⚠ Do not use a configuration of the function block as 0÷20 mA or 0÷10 V input for safety purposes. If you use a configuration of the function block as 0÷20 mA or 0÷10 V input for non safety purposes, implement all measures required to avoid unintended equipment operation and any other hazard.

<b>Measurement unit</b> °C	
<b>Input 1: Scale</b>	<b>Input 2: Scale</b>
4 mA: 0 °C	4 mA: 0 °C
20 mA: 100 °C	20 mA: 100 °C
Slope: 6,25 °C/mA	Slope: 6,25 °C/mA
Offset: -25 °C	Offset: -25 °C
<input type="checkbox"/> 0÷20mA Input <input type="checkbox"/> 0÷10V Input	

Input type: 4÷20mA -> no selection

<b>Measurement unit</b> °C	
<b>Input 1: Scale</b>	<b>Input 2: Scale</b>
0 mA: 0 °C	0 mA: 0 °C
20 mA: 100 °C	20 mA: 100 °C
Slope: 5 °C/mA	Slope: 5 °C/mA
Offset: 0 °C	Offset: 0 °C
<input checked="" type="checkbox"/> 0÷20mA Input <input type="checkbox"/> 0÷10V Input	

Input type: 0÷20mA -> 0÷20mA Input selected



<b>Measurement unit</b>		°C	
<b>Input 1: Scale</b>		<b>Input 2: Scale</b>	
0 V:	0 °C	0 V:	0 °C
10 V:	100 °C	10 V:	100 °C
Slope	10 °C/V	Slope	10 °C/V
Offset	0 °C	Offset	0 °C
<input checked="" type="checkbox"/> 0÷20mA Input			
<input checked="" type="checkbox"/> 0÷10V Input			

Input type: 0÷10V -> 0÷10V Input selected

### Division analysis: Window comparator

If you activate the option Window comparator, the output Out1 is added to the graphical representation of the function block and a number of additional parameters are displayed.

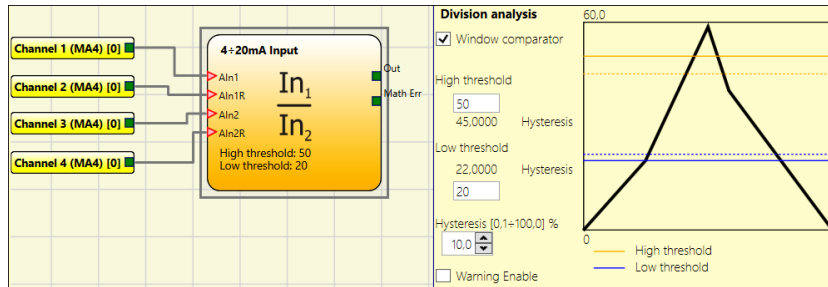

The following parameters are provided to define the behavior of the Window comparator:

High threshold: is the maximum value of the range set for the window.

Low threshold: is the minimum value of the range set for the window.

Hysteresis: is the hysteresis value for the window.

The output state of the window comparator depends on the value of the division and on its actual logic state. There are two possible states:

- ➔ **OUT OF WINDOW:** the output of the comparator is a logical value 0 If the state of the Window comparator is Out of Window, the output of the Window comparator is FALSE.
- ➔ **IN WINDOW:** the output of the comparator is a logical value 1 If the state of the Window comparator is In Window, the output of the Window comparator is TRUE.

The following figure and table exemplify the states of the Window comparator:

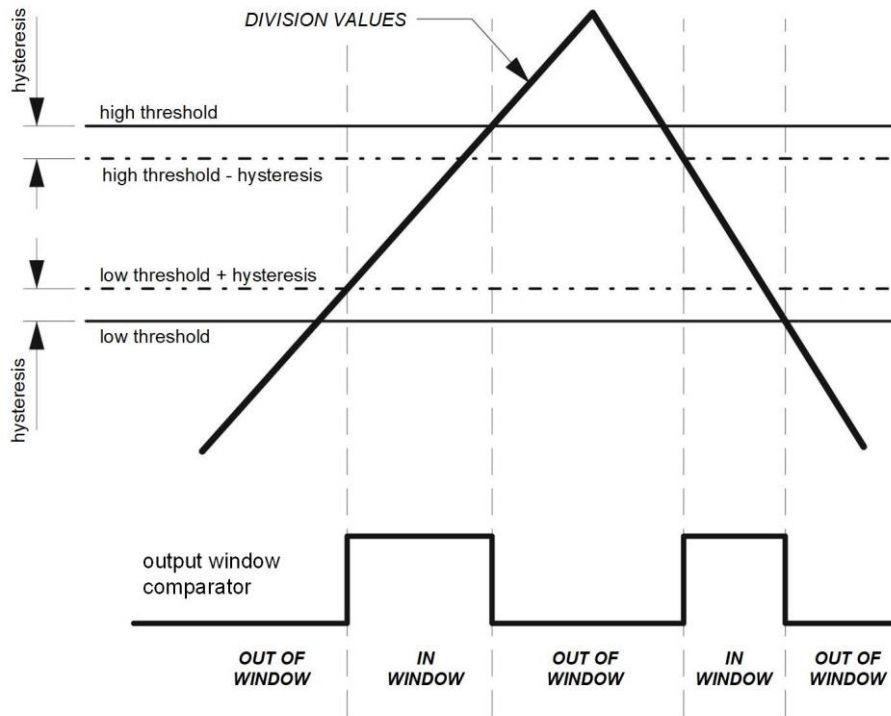

Division value (A)	Current state of window comparator	Next state of window comparator
(A) < Low threshold value + hysteresis	OUT OF WINDOW	OUT OF WINDOW
(A) > High threshold	OUT OF WINDOW	OUT OF WINDOW
(A) >= High threshold value - hysteresis	OUT OF WINDOW	OUT OF WINDOW
(A) <= Low threshold value	OUT OF WINDOW	OUT OF WINDOW
(A) < High threshold value - hysteresis	OUT OF WINDOW	IN WINDOW
(A) > Low threshold value	OUT OF WINDOW	IN WINDOW
(A) < High threshold value	IN WINDOW	IN WINDOW
(A) > Low threshold value + hysteresis	IN WINDOW	IN WINDOW

**Division analysis: Enable threshold**

If you activate the option Enable threshold, the output Out is added to the graphical representation of the function block and a number of additional parameters are displayed.

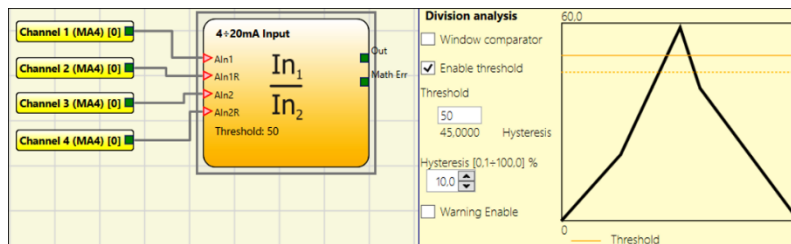

The following parameters are provided to define the behavior of the Threshold comparator:

- Threshold: is the value of the threshold.
- Hysteresis: is the hysteresis value

The following figure and table exemplify the states of the Enable threshold:

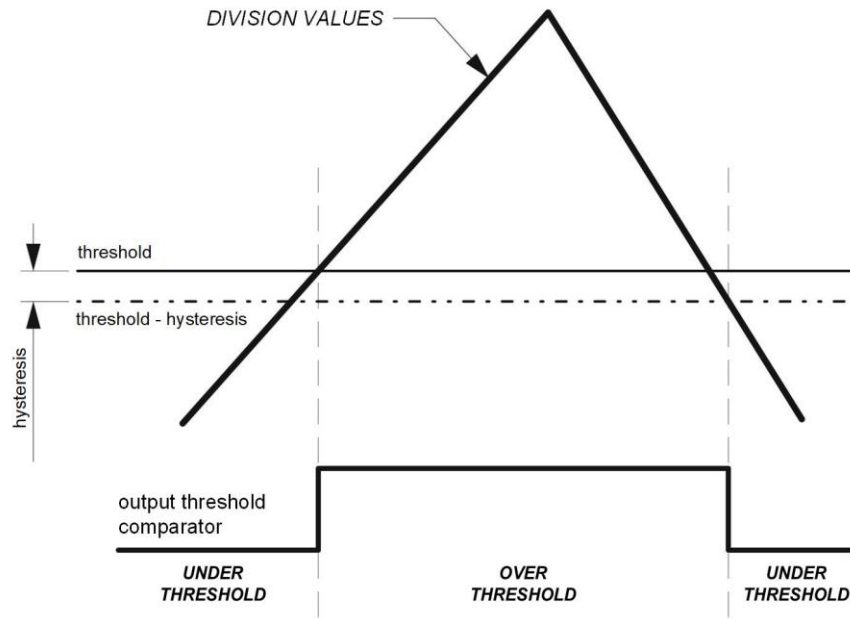

DIVISION VALUES (A)	Current state of threshold comparator	Next state of threshold comparator
(A) < Threshold value - hysteresis	UNDER THRESHOLD	UNDER THRESHOLD
(A) <= Threshold value	UNDER THRESHOLD	UNDER THRESHOLD
(A) > Threshold value	UNDER THRESHOLD	OVER THRESHOLD
(A) < Threshold value - hysteresis	OVER THRESHOLD	OVER THRESHOLD
(A) < Threshold value - hysteresis	OVER THRESHOLD	UNDER THRESHOLD

**Division analysis: Warning enable -> warning threshold**

If you activate the Warning enable, a further output is added to the function block. You can specify a threshold value and a hysteresis.

The option "Lower limit" determines the behavior of the comparison.

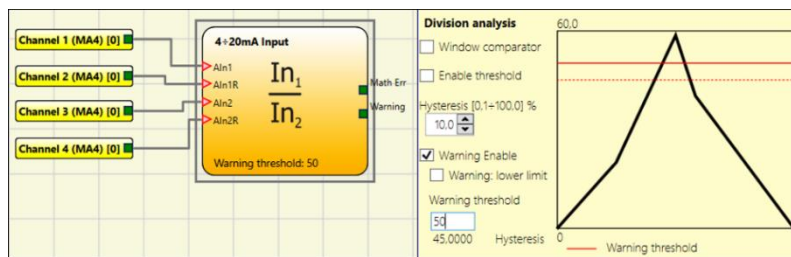

**Division analysis: Warning enable -> threshold -> hysteresis**

Following it is described the behaviour of the alert threshold comparator when "Alert lower limit" is not selected.

The output state of the Warning comparator depends on the value of the measurement and on its current state. There are two possible states:

- ➔ **OVER THRESHOLD:** the output of the comparator is a logic 1 (TRUE)
- ➔ **UNDER THRESHOLD:** the output of the comparator is a logic 0 (FALSE)

The following figure and table exemplify the states of the Alert threshold:

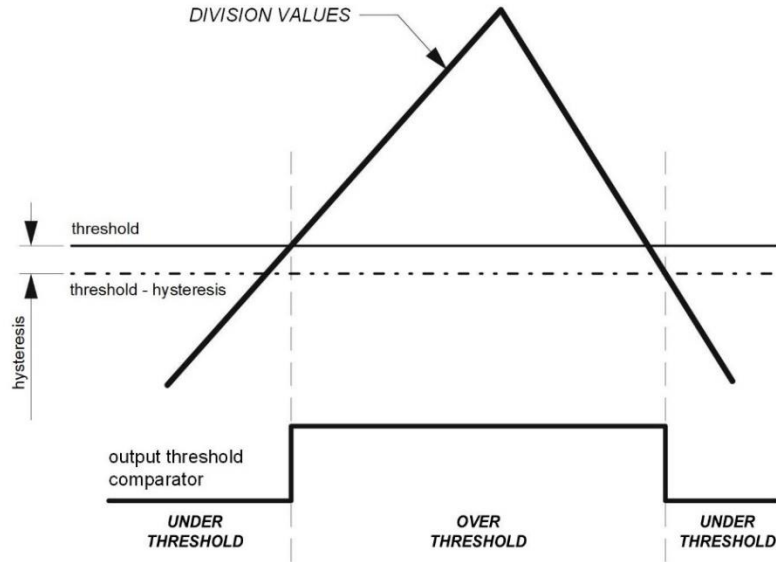
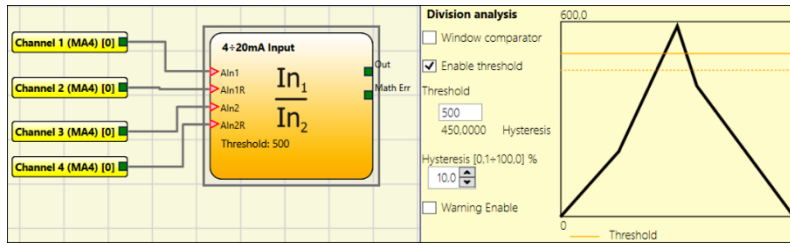

Division values (A)	Current state of threshold comparator	Next state of threshold comparator
$(A) < \text{Threshold value}$	UNDER THRESHOLD	UNDER THRESHOLD
$(A) \leq \text{Threshold value} + \text{hysteresis}$	UNDER THRESHOLD	UNDER THRESHOLD
$(A) > \text{Threshold value} + \text{hysteresis}$	UNDER THRESHOLD	OVER THRESHOLD
$(A) > \text{Threshold value}$	OVER THRESHOLD	OVER THRESHOLD
$(A) < \text{Threshold value}$	OVER THRESHOLD	UNDER THRESHOLD

**Samples per second**

Lets you select the number of samples per second of the analog to digital converter. The lower the value, the less the reading is susceptible to noise. The higher the value, the shorter the response time. The Samples per second values 50 and 60 enhance the AC power line filter rejection.

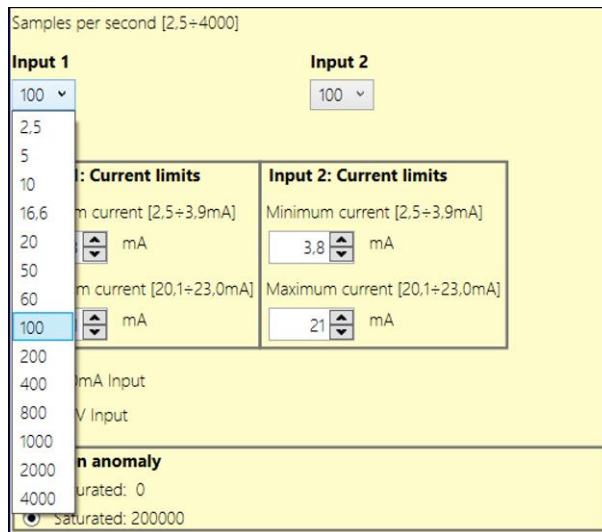

English

*Current limits / voltage*

**Current sensors: current limits**

With the following parameters you can limit the measurement range by setting a minimum and a maximum permissible current:

- Minimum current: The range for the minimum permissible current is 2,5 to 3,9 mA.
- Maximum current: The range for the maximum permissible current is 20,1 to 23 mA.

If the measurement values are under the minimum value or above the maximum value, then the MA2/MA4 module detects a anomaly and raise diagnostics.

Input 1: Current limits	Input 2: Current limits
Minimum current [2,5÷3,9mA] 3,8 mA	Minimum current [2,5÷3,9mA] 3,8 mA
Maximum current [20,1÷23,0mA] 21 mA	Maximum current [20,1÷23,0mA] 21 mA

The following table summarizes MA2/MA4 module behaviour as a function of measurement values.

Measurement value (A)	Diagnostic
(A) < Minimum current limit	YES
(A) > Maximum current limit	YES
Minimum current limit < (A) < Maximum current limit	NO

**Voltage sensors: voltage limits**

With the following parameters you can limit the measurement range by setting a minimum and a maximum permissible voltage:

- Minimum voltage: The value is set to 0 V and cannot be changed.
- Maximum voltage: The range for the maximum permissible voltage is 10,05 VDC to 11,5 VDC.

Input 1: Voltage limits	Input 2: Voltage limits
Minimum voltage [0 V] 0 V	Minimum voltage [0 V] 0 V
Maximum voltage [10,05÷11,50V] 10,5 V	Maximum voltage [10,05÷11,50V] 10,5 V

If the measurement values are above the maximum value, then the MA2/MA4 module detects a anomaly and raise diagnostics.

The following table summarizes MA2/MA4 module behaviour as a function of measurement values.

Measurement value (A)	Diagnostic
(A) < Minimum voltage limit	NO
(A) > Maximum voltage limit	YES
Minimum voltage limit < (A) < Maximum voltage limit	NO

**Division anomaly: division saturated at 0 or 200000**

This option let you to choose which value the MA2/MA4 module will force to the division when a mathematical error is detected.

**Division anomaly**

Saturated: 0  
 Saturated: 200000

**Analog Output**  Analog Output

If this option is selected, the raw values of the measurements are available within MSD by using the Graphical Monitor. This is graphically represented on the function block by a light green square and the label Analog.

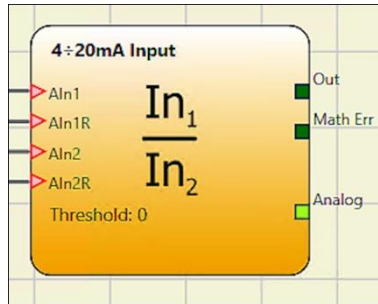

**Enable Error Out**

 Enable Error Out

If selected, provides an output to indicate that an error has been detected by the function block. This is graphically represented on the function block by a dark green square and the label Error.

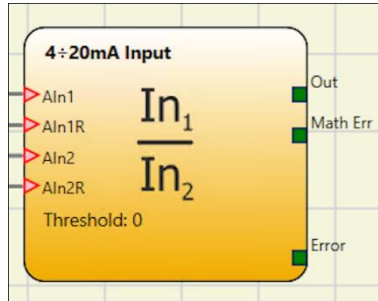

**Math Err**

The output Math Err provides the state of the division:

Anomaly	“Math Err” Value
Division by 0	1 (TRUE)
Disconnected cable diagnosis detected	1 (TRUE)
Output overload detected	1 (TRUE)
Input overload detected	1 (TRUE)
Mismatch detected (only with redundant sensors)	1 (TRUE)
Normal operation	0 (FALSE)

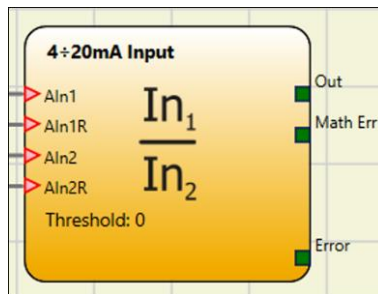

## OPERATOR FUNCTION BLOCKS

All the input of these operators could be inverted (logical NOT). It could be done clicking with the right mouse key on the input to be inverted. A little circle will be showed on the inverted input. To cancel the inversion, simply click another time on the same input pin.

➔ The maximum number of functional blocks is 64 with MOSAIC M1 or 128 with MOSAIC M1S, MOSAIC M1S COM.

### LOGICAL OPERATORS

#### AND

Logical AND returns an output of 1 (TRUE) if all the inputs are 1 (TRUE).

In <sub>1</sub>	In <sub>2</sub>	In <sub>x</sub>	Out
0	0	0	0
1	0	0	0
0	1	0	0
1	1	0	0
0	0	1	0
1	0	1	0
0	1	1	0
1	1	1	1

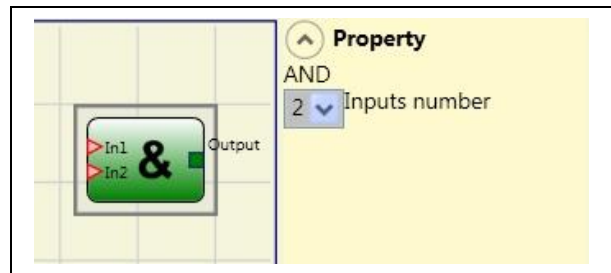

#### Parameters

**Number of inputs:** this is used to set between 2 and 8 inputs.

#### NAND

Logical NAND returns an output of 0 (FALSE) if all the inputs are 1 (TRUE).

In <sub>1</sub>	In <sub>2</sub>	In <sub>x</sub>	Out
0	0	0	1
1	0	0	1
0	1	0	1
1	1	0	1
0	0	1	1
1	0	1	1
0	1	1	1
1	1	1	0

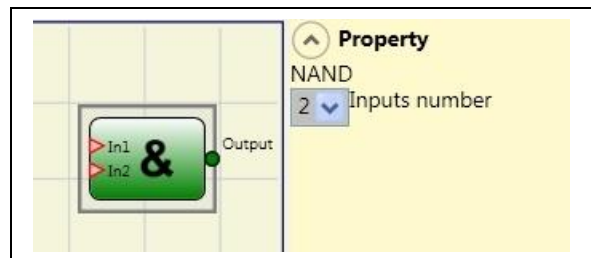

#### Parameters

**Number of inputs:** this is used to set between 2 and 8 inputs.



## NOT

Logical NOT inverts the logical status of the input.

In	Out
0	1
1	0

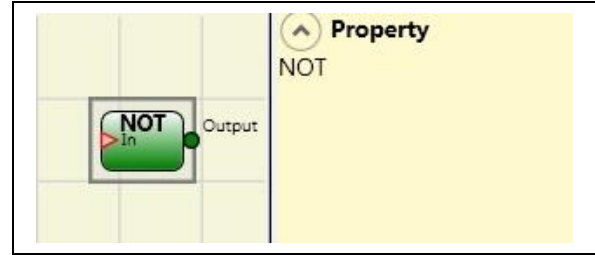

## OR

Logical OR returns an output of 1 (TRUE) if at least one of the inputs is 1 (TRUE).

In <sub>1</sub>	In <sub>2</sub>	In <sub>x</sub>	Out
0	0	0	0
1	0	0	1
0	1	0	1
1	1	0	1
0	0	1	1
1	0	1	1
0	1	1	1
1	1	1	1

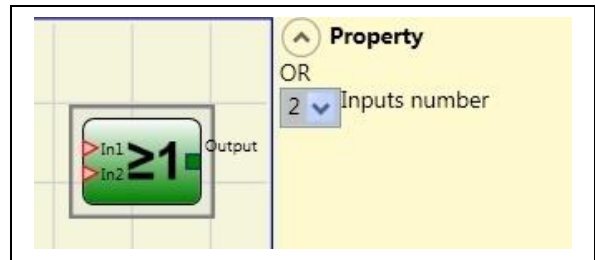

## Parameters

**Number of inputs:** this is used to set between 2 and 8 inputs.

## NOR

Logical NOR returns an output of 0 (FALSE) if at least one of the inputs is 1 (TRUE).

In <sub>1</sub>	In <sub>2</sub>	In <sub>x</sub>	Out
0	0	0	1
1	0	0	0
0	1	0	0
1	1	0	0
0	0	1	0
1	0	1	0
0	1	1	0
1	1	1	0

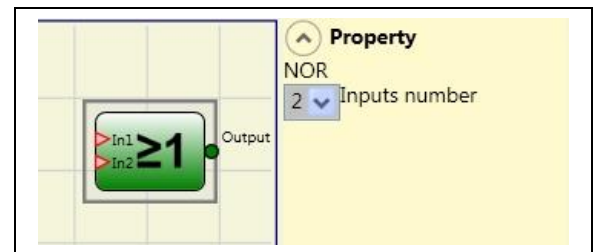

## Parameters

**Number of inputs:** this is used to set between 2 and 8 inputs.

**XOR**

Logical XOR returns an output 0 (FALSE) if the input's number at 1 (TRUE) is even or the inputs are all 0 (FALSE).

In1	In2	Inx	Out
0	0	0	0
1	0	0	1
0	1	0	1
1	1	0	0
0	0	1	1
1	0	1	0
0	1	1	0
1	1	1	1

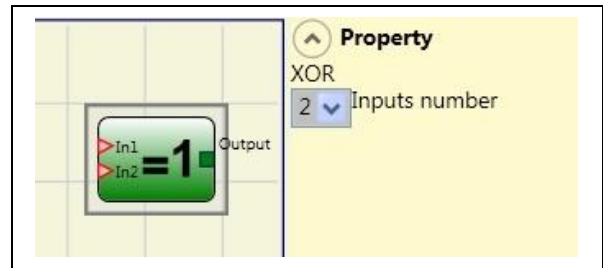

**Parameters**

**Number of inputs:** this is used to set between 2 and 8 inputs.

**XNOR**

Logical XNOR returns an output 1 (TRUE) if the input's number at 1 (TRUE) is even or the inputs are all 0 (FALSE).

In1	In2	Inx	Out
0	0	0	1
1	0	0	0
0	1	0	0
1	1	0	1
0	0	1	0
1	0	1	1
0	1	1	1
1	1	1	0

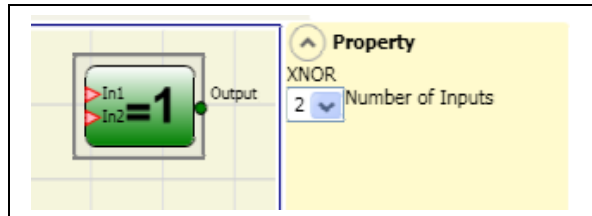

**Parameters**

**Number of inputs:** this is used to set between 2 and 8 inputs.

**LOGICAL MACRO**

This operator enables the grouping together of two or three logic gates.  
 A maximum of 8 inputs is foreseen.  
 The result of the first two operators converges into a third operator, the result of which is the OUTPUT.

**Parameters**

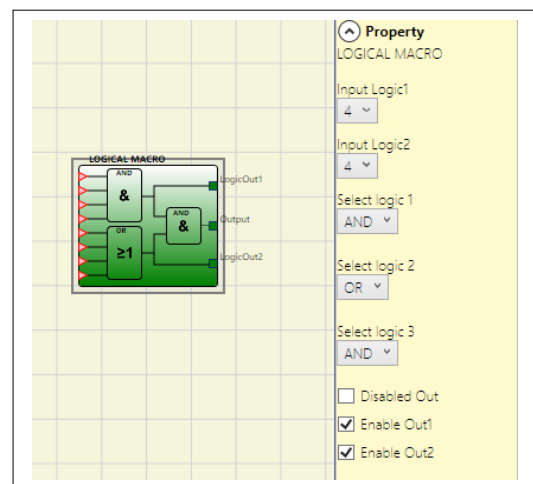

**Logic inputs 1, 2:** enables the selection of the number of logic inputs (from 1 to 7).

**Select Logic 1, 2, 3:** enables the selection of one of the following types of operator:

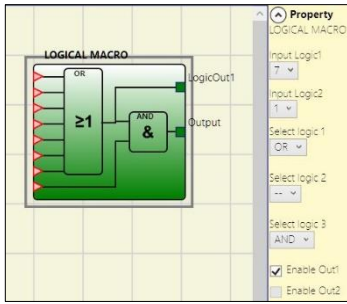

If one of the Logic Inputs equals "1", the corresponding logic is disabled and the input is directly connected to the end logic (e.g. see diagram on the left).

AND, NAND, OR, NOR, XOR, XNOR, SR Flip-Flop (the latter only for logic 3).

**Disable OUT:** If selected, it deactivates the main output allowing to use only logics 1 and/or 2 enabling their respective outputs

**Enable (OUT1, OUT2):** If selected, it activates an output with the result of logics 1 and/or 2.

## MULTIPLEXER

Logical MULTIPLEXER forwards the signal of the inputs to the output according to the Sel selection. If the SEL1÷SEL4 have only one bit set, the selected **In n** is connected to the **Output**. As an example if "Sel2" is set to 1 then the "In 2" is forwarded to the "Output" the SEL inputs are:

- more than one = 1 (TRUE)
- none = 1 (TRUE)

the output is set to 0 (FALSE) independently from the **In n** values.

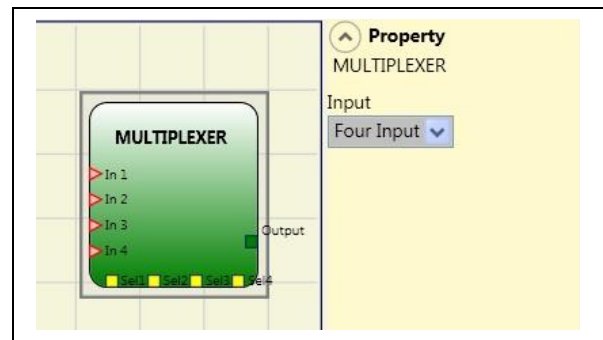

## Parameters

**Number of inputs:** this is used to set between 2 and 4 inputs.

## DIGITAL COMPARATOR (MOSAIC M1S, MOSAIC M1S COM only)

The digital comparator allows to compare (in binary format) a group of signals with a constant or two groups of signals to each other

### Comparison with constant

In this case the Signal Comparator check must not be activated.

The DIGITAL COMPARATOR block allows to compare a series of input signals (from 2 to a maximum of 8). The integer constant could be inputted directly as Decimal number or as a combination of binary values. In the latter In1 is the LSB (least significant bit) while

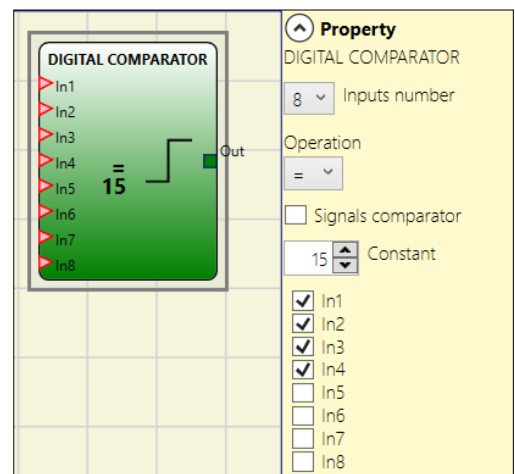

input In8 (or less if the number of inputs selected is less than 8) is the MSB (most significant bit).

Example of operator with 8 inputs:

In1 → 0  
 In2 → 1  
 In3 → 1  
 In4 → 0  
 In5 → 1  
 In6 → 0  
 In7 → 0  
 In8 → 1

Decimal value equal to 150.

Example of operator with 5 inputs:

In1 → 0  
 In2 → 1  
 In3 → 0  
 In4 → 1  
 In5 → 1

Decimal value equal to 26.

The user could choice among various operation listed below:

- **< (Lower)** The OUT output will be 1 (TRUE) as long as the input value is less than the decimal value set as constant. The OUT output will be set to 0 (FALSE) when the input value is higher than or equal to the decimal value set as constant.
- **>= (Higher) or equal** The OUT output will be 1 (TRUE) as long as the input value is higher than or equal to the decimal value set as constant. The OUT output will be set to 0 (FALSE) when the input value is lower than the decimal value set as constant.
- **> (Higher)** The OUT output will be 1 (TRUE) as long as the input value is higher than the decimal value set as constant. The OUT output will be set to 0 (FALSE) when the input value is lower than or equal to the decimal value set as constant.
- **<= (Lower or equal)** The OUT output will be 1 (TRUE) as long as the input value is lower than or equal to the decimal value set as constant. The OUT output will be set to 0 (FALSE) when the input value is higher than the decimal value set as constant.
- **= (Equal)** The OUT output will be 1 (TRUE) as long as the input value is equal to the decimal value set as constant. The OUT output will be set to 0 (FALSE) when the input value is different from the decimal value set as constant.
- **!= (Different)** The OUT output will be 1 (TRUE) as long as the input value is different from the decimal value set as constant. The OUT output will be set to 0 (FALSE) when the input value is equal to the decimal value set as constant.

## Signal comparison

Signal comparison: Selecting this item will allow the DIGITAL COMPARATOR operator to compare the first four A inputs (In1\_A...In4\_A) with the second four B inputs (In1\_B...In4\_B).

Depending on the value of the inputs and the operation selected, the following results will be obtained:

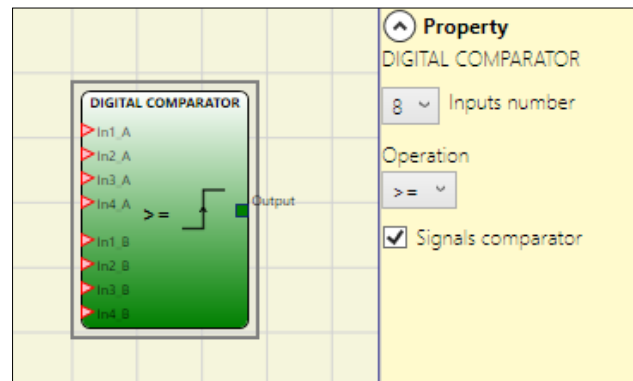

- < (Lower): The OUT output will be 1 (TRUE) as long as the value of A inputs is lower than the value of B inputs. The OUT output will be set to 0 (FALSE) when the value of A inputs is higher than or equal to the value of B inputs.
- >= (Higher or equal): The OUT output will be 1 (TRUE) as long as the value of A inputs is higher than or equal to the value of B inputs. The OUT output will be set to 0 (FALSE) when the value of A inputs is lower than the value of B inputs.
- > (Higher): The OUT output will be 1 (TRUE) as long as the value of A inputs is higher than the value of B inputs. The OUT output will be set to 0 (FALSE) when the value of A inputs is lower than or equal to the value of B inputs.
- <= (Lower or equal): The OUT output will be 1 (TRUE) as long as the value of A inputs is lower than or equal to the value of B inputs. The OUT output will be set to 0 (FALSE) when the value of A inputs is higher than the value of B inputs.
- = (Equal): The OUT output will be 1 (TRUE) as long as the value of A inputs is equal to the value of B inputs. The OUT output will be set to 0 (FALSE) when the value of A inputs is different from the value of B inputs.
- != (Different): The OUT output will be 1 (TRUE) as long as the value of A inputs is different from the value of B inputs. The OUT output will be set to 0 (FALSE) when the value of A inputs is equal to the value of B inputs.

MEMORY OPERATORS

MEMORY operators can be used if you decide to save any data (TRUE or FALSE) from other project components.

Status changes are performed according to the truth tables shown for each operator.

**D FLIP FLOP (max number = 16)**

The D FLIP FLOP operator saves the previously set status on output Q according to the following truth table.

Preset	Clear	Ck	D	Q
1	0	X	X	1
0	1	X	X	0
1	1	X	X	0
0	0	0	X	Keep memory
0	0	Rising edge	1	1
0	0	Rising edge	0	0

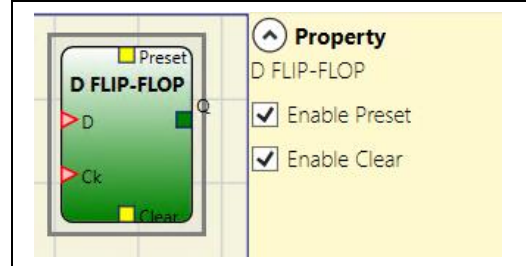

**Parameters**

**Preset:** If selected enables output Q to be set to 1 (TRUE).

**Clear:** If selected enables the saving process to be reset.

**T FLIP FLOP (max number = 16)**

This operator switches the Q output at each rising edge of the T input (Toggle).

**Parameters**

**Enable Clear:** If selected enables the saving process to be reset.

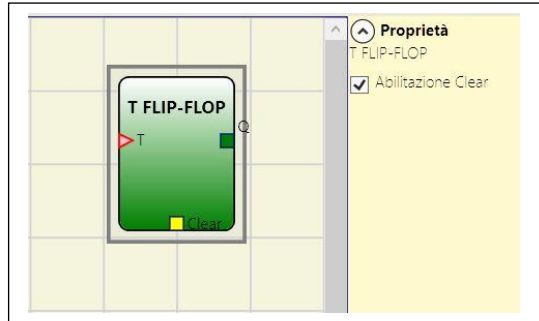

**SR FLIP FLOP**

SR FLIP FLOP operator brings output Q at 1 with Set, 0 with Reset. See the following truth table.

SET	RESET	Q
0	0	Keep memory
0	1	0
1	0	1
1	1	0

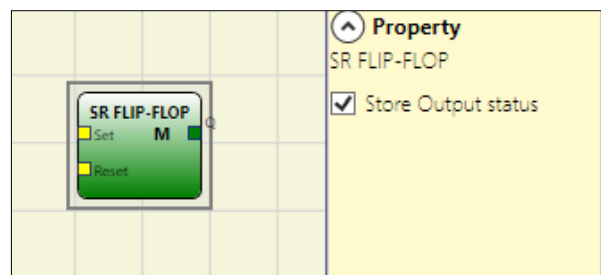

**Parameters**

**Store output status:** If selected, it stores the output status of the Flip-flop in non-volatile memory every time it is changed. When the system is turned on, the last stored value is restored.

It is possible to have up to 8 Flip-Flops with output status storage that will be distinguishable by an 'M'.

- ➔ Some limitations to the use of this storage. The maximum time required for a single storage is estimated at 50ms and the maximum number of possible storages is set at 100000.
- ➔ The total number of storages must not exceed the set limit, otherwise the operational life of the product will be reduced, and the frequency of such storages must be sufficiently low to enable them to be stored safely.

**USER RESTART MANUAL**

(max number = 16 with MOSAIC M1, 32 with MOSAIC M1S, MOSAIC M1S COM with other RESTART operators)

The USER RESTART MANUAL operator saves the restart signal (coming from a RESTART command device) according to the following truth table.

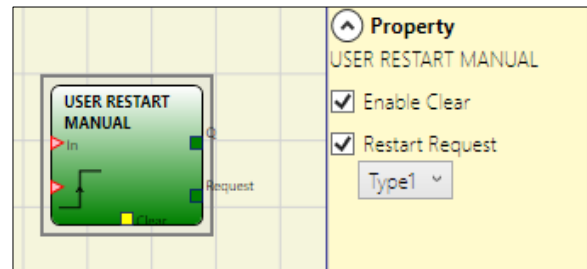

Clear	Restart	In	Q	Restart Request Type 1	Restart Request Type 2*
1	X	X	0	0	1
X	X	0	0	0	1
0	0	1	Keep Memory	1	Blinking 1Hz
0	Rising Edge	1	1	0	0

**Parameters**

**Clear enable:** If selected, enables an input to reset the memorization.

**Restart request:** If selected, it enables an output that can be used to signal the possibility of performing the Restart. The behaviour can be of type 1 or type 2 (type 2 only with MOSAIC M1S, MOSAIC M1S COM) as represented in the truth table.



\* Restart Request Type 2 uses a system timer

**USER RESTART MONITORED**

(max number = 16 with MOSAIC M1, 32 with MOSAIC M1S, MOSAIC M1S COM with other RESTART operators)

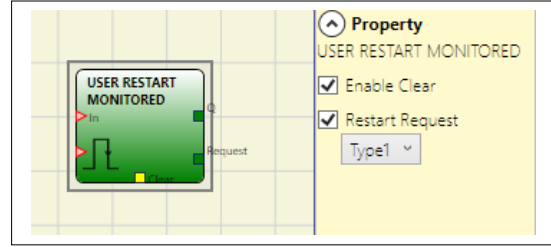
The USER RESTART MONITORED operator is used to save the restart signal (coming from a RESTART command device) according to the following truth table.



Clear	Restart 	In	Q	Restart Request Type 1	Restart Request Type 2*
1	X	X	0	0	1
X	X	0	0	0	1
0	0	1	Keep Memory	1	Blinking 1Hz
0		1	1	0	0

**Parameters**

**Clear enable:** If selected, enables an input to reset the memorization.

**Restart request:** If selected, it enables an output that can be used to signal the possibility of performing the Restart. The behaviour can be of type 1 or type 2 (type 2 only with MOSAIC M1S, MOSAIC M1S COM) as represented in the truth table.

\*This output uses a system timer

**MACRO RESTART MANUAL**

(max number = 16 with MOSAIC M1, 32 with MOSAIC M1S, MOSAIC M1S COM with other RESTART operators)

The MACRO RESTART MANUAL operator is used to combine a logic gate chosen by the user with the Restart Manual functional block ("USER RESTART MANUAL") in accordance with the following truth table.

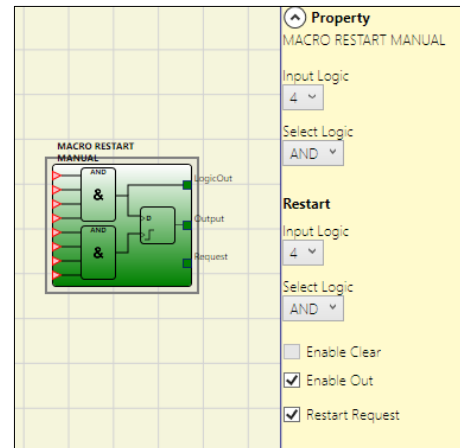

Clear	Restart Logic Out	Input Logic Out	Output	Restart Request
1	X	X	0	0
X	X	0	0	0
0	0	1	Keep memory	1
0	Rising Edge 	1	1	0



**Parameters**

**Input Logic:** enables the selection of the number of logic inputs (from 1 to 7). Selecting 1 the logic will not be considered.

**Select Logic:** enables the selection of one of the following types of operator: AND, NAND, OR, NOR, XOR, XNOR.

**Restart Input Logic (only MOSAIC M1S, MOSAIC M1S COM):** enables the selection of the number of inputs for restart logic (from 1 to 7). If you select 1 the logic will not be considered.

**Restart Select Logic (only MOSAIC M1S, MOSAIC M1S COM):** enables the selection of one of the following types of operator for restart logic: AND, NAND, OR, NOR, XOR, XNOR.

**Enable Clear:** If selected, enables an input to reset the memorization.

**Enable Out:** If selected activates an output with the result of the calculation done by the input logic.

**Restart request:** If selected, it enables an output that can be used to signal the possibility of performing the Restart. The behaviour is represented in the truth table.

**MACRO RESTART MONITORED**

(max number = 16 with MOSAIC M1, 32 with MOSAIC M1S, MOSAIC M1S COM with other RESTART operators)

The MACRO RESTART MONITORED operator is used to combine a logic gate chosen by the user with the Restart Manual functional block ("USER RESTART MONITORED") in accordance with the following truth table.

Clear	Restart Logic Out	Input Logic Out	Output	Restart Request
1	X	X	0	0
X	X	0	0	0
0	0	1	Keep memory	1
0		1	1	0

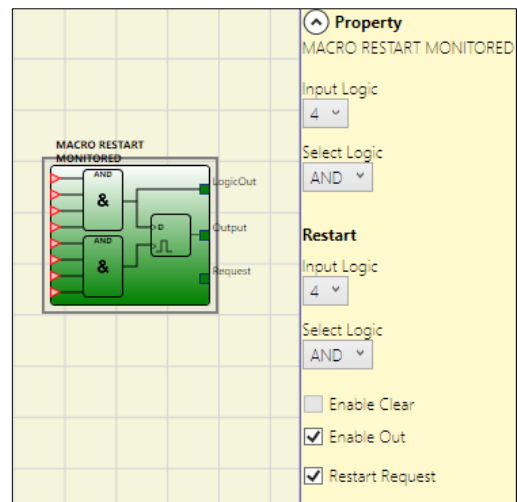

**Parameters**

**Input Logic:** enables the selection of the number of logic inputs (from 1 to 7). Selecting 1 the logic will not be considered.

**Select Logic:** enables the selection of one of the following types of operator: AND, NAND, OR, NOR, XOR, XNOR.

**Restart Input Logic (only MOSAIC M1S, MOSAIC M1S COM):** enables the selection of the number of inputs for restart logic (from 1 to 7). If you select 1 the logic will not be considered.

**Restart Select Logic (only MOSAIC M1S, MOSAIC M1S COM):** enables the selection of one of the following types of operator for restart logic: AND, NAND, OR, NOR, XOR, XNOR.

**Enable Clear:** If selected, enables an input to reset the memorization.

**Enable Out:** If selected activates an output with the result of the calculation done by the input logic.

**Restart request:** If selected, it enables an output that can be used to signal the possibility of performing the Restart. The behaviour is represented in the truth table.

**PRE-RESET (MOSAIC M1S, MOSAIC M1S COM only) (max number = 32 with other RESTART operators)**

The PRE-RESET operator can be used when there is no possibility of having a single reset button in a position from which a complete visibility of the hazardous area is available. In this case it is necessary to use a PRE-RESET button inside a zone of operation with a complete visibility and a RESET button outside the zone of operation to activate the Q output. For both Pre-reset and Reset inputs the transition 0->1->0 is considered a valid signal. It is mandatory that the pulse 0->1->0 has a maximum duration of 5s.

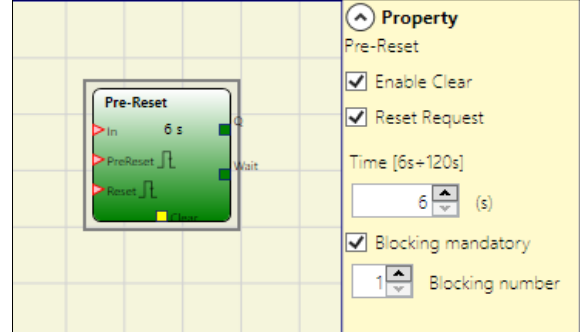

**Parameters**

**Time:** The external reset is operative if pressed within a preset time configurable by the user in the range 6÷120s

**Blocking Mandatory:** If selected, the minimum number of interruptions (of the light curtain or similar) is 1 before the RESET signal can be activated.

If you specify a BLOCKING NUMBER other than 1, this number corresponds to the maximum permissible number of interruptions.

**Blocking number:** Blocking number has the range from 1 to 7.

**Reset Request:** Enabling this item will make available an output from this operator. This signal is 1 from the PreReset signal transition to the end of the allowable time or to the next Reset signal transition.

**Enable Clear:** If selected, enables an input to reset the memorization.

The behavior of the PRE-RESET operator is shown in the following timings:

WITHOUT BLOCKING MANDATORY

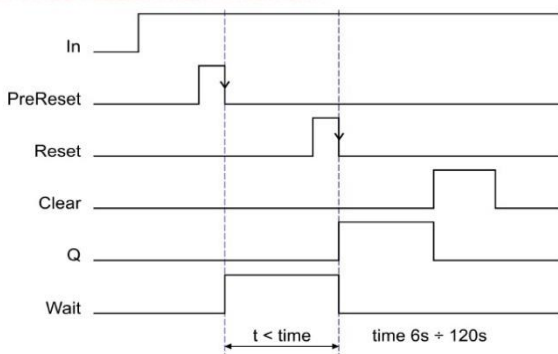

WITH BLOCKING MANDATORY (Blocking number = 2)

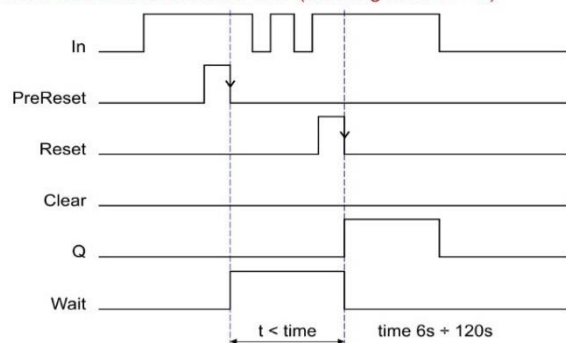

GUARD LOCK OPERATOR (max number = 4 with MOSAIC M1, 8 with MOSAIC M1S, MOSAIC M1S COM)

**GUARD LOCK**

The “**GUARD LOCK**” operator is designed to control locking/unlocking of an ELECTROMECHANICAL GUARD LOCK in a variety of operating contexts.

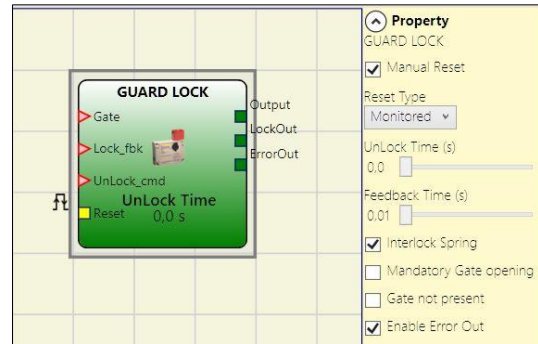

**Parameters**

Manual Reset:

There are two types of reset: Manual and Monitored. When Manual is selected the system only verifies the signal's transition from 0 to 1. If Monitored is selected the double transition from 0 to 1 and then back to 0 is verified.

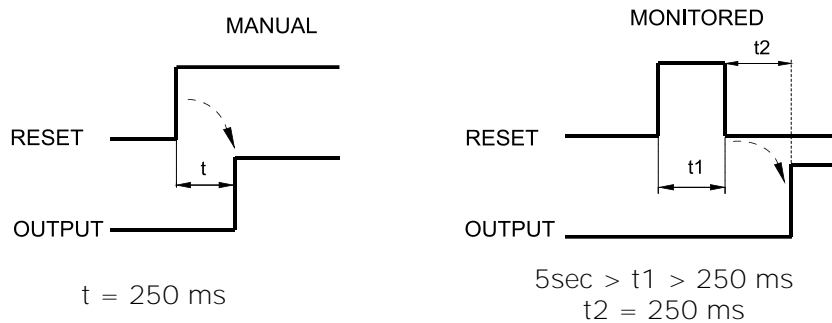

Unlock Time (s):

The time that must pass between the UnLock\_cmd input reaching and the real guard unlock (Lockout output).

- 0ms...1 s Step 100 ms
- 1.5 s...10 s Step 0.5 s
- 15 s...25 s Step 5 s

Feedback Time (s):

Maximum delay accepted between LockOut output and Lock\_fbk input (must be the one shown on the lock data sheet with appropriate gap decided by the operator).

- 10ms...100 s Step 10 ms
- 150ms...1 s Step 50 ms
- 1.5 s...3 s Step 0.5 s

Interlock Spring: The guard is locked passively and released actively, i.e. the mechanical force of the spring keeps it locked. **The guard thus continues to be locked even when the power supply is disconnected.**

Mandatory gate opening: Only with door opening and subsequent confirmation of input GATE, the cycle proceeds.

Gate not present: If selected, enables configuration without Gate but only with LOCK FEEDBACK (feedback coil lock).

Enable error out: This can be selected to enable a signal (Error Out) to indicate a lock malfunction. When Error Out = 1 (TRUE) there is a fault in the lock. (e.g. open door with guard lock locked, Feedback Time exceeding the maximum allowed, etc.).

**Description of "GUARD LOCK" operator inputs/outputs**

**"Lock\_fbk" input**

The "Lock\_fbk" input is used to detect the status (feedback) of the electromagnet that unlocks/locks the guard lock.

Electromechanical guard locks are unlocked/locked via an electric control that energises/de-energises an electromagnet. Its status (energised/de-energised) is indicated by appropriate contacts. For example, the status of the electromagnet may be indicated by a normally open contact that is closed when the electromagnet is energised, as in the case shown in Figure 101.

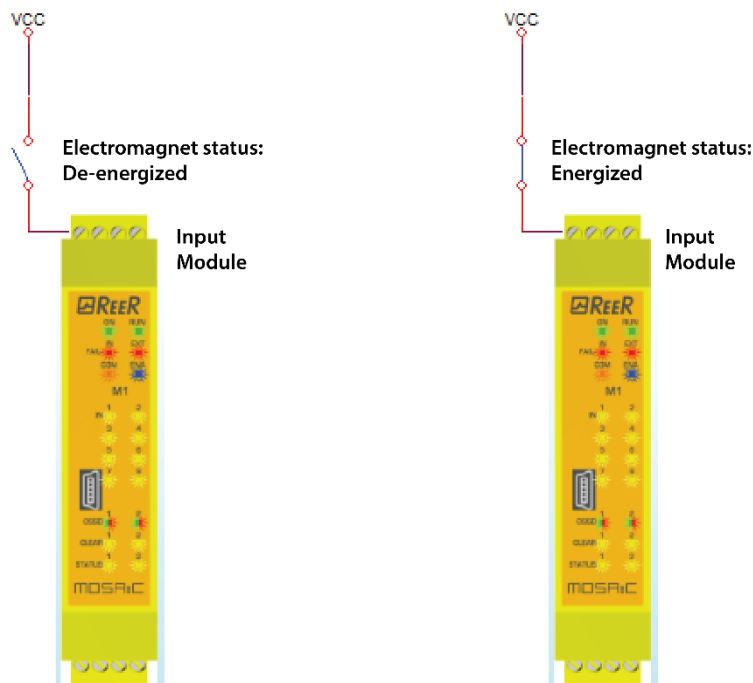

Figure 101 - Example of feedback of the status of the electromagnet of a guard lock. The signal received by the module is processed by the "Guard Lock" operator.

**"Gate" input**

When the "Gate" input is present, it detects the status (feedback) of the door/gate connected to the guard lock.

The status of the door/gate (GATE) is detected using specific contacts. For example, the status of the door/gate may be indicated by a normally open contact that is closed when the door/gate is closed, as in the case in Figure 102.

English

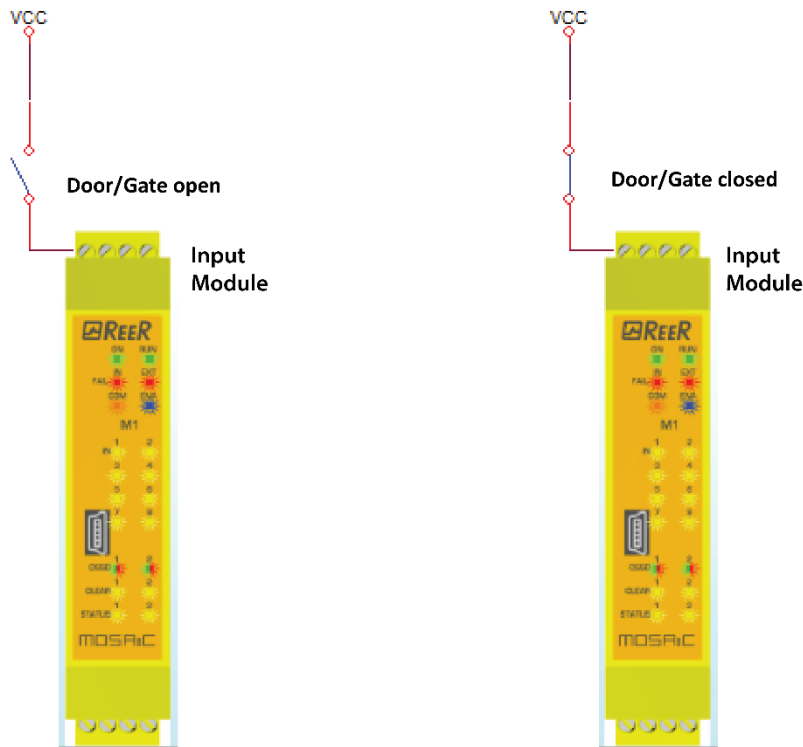

Figure 102 - Example of feedback of the status of a door/gate connected to the guard lock. The signal received by the module is processed by the "Guard Lock" operator.

**"Unlock\_cmd" input**

The "Unlock\_cmd" input detects the command sent by the user to lock or unlock the guard lock. In detail:

- Request to unlock: the Unlock\_cmd signal must be set to LL1
- Request to lock: the Unlock\_cmd signal must be set to LL0

The command signal may be sent via a key, for example.

**"Output" out**

This signal indicates the information shown in the table below, depending on its value.

	Value	Meaning
Output	LL1	<ul style="list-style-type: none"> <li>• Door/Gate closed</li> <li>• Guard lock locked</li> </ul>
Output	LL0	<ul style="list-style-type: none"> <li>• User request to unlock the guard lock</li> <li>• Error condition</li> </ul>

**"LockOut" output**

This signal controls the guard lock electromagnet and can assume LLO and LL1 value.

**"ErrorOut" output**

If enabled, when this signal is set to LL1 it indicates an error in the control of the guard lock. It is set to LLO when no errors have occurred.

**Operation: general description**

The "Guard Lock" operator analyses consistency between the status of the "Unlock\_cmd" signal, the status of a door/gate (E-GATE), if present, via the "Gate" signal, and the status of the electromagnet via the "Lock\_fbk" signal. The main output, "Output", is LL1 (TRUE) when the guard lock is closed and locked.

**Operation in the "no Gate" mode**

In this case, the user must select the "Gate not present" parameter.

The Lock\_Fbk input must always be connected to a "LOCK FEEDBACK" input element (see the LOCK FEEDBACK section on page 140) that verifies the status of the guard lock electromagnet.

The UnLock\_cmd input can be connected freely in the diagram and determines the request to unlock the guard lock (when set to LL1).

The Output signal is LL1 (TRUE) if the safety guard is locked. When an unlock command is applied to the UnLock\_cmd input, the Output signal is set to LLO and the guard lock is unlocked via the LockOut signal.

The Output signal can also be set to LLO (FALSE) when error conditions are present. (e.g. **Feedback Time** exceeding the maximum allowed, etc.).

When the UnLock\_cmd signal is detected, the LockOut signal unlocks the guard lock after the **UnLock Time**, a parameter that can be defined by the user.

The time after which the electromagnet is activated depends entirely on the technical/physical characteristics of the specific device and may therefore vary according to the type of guard lock used. Thus, since the LockOut signal controls the activation of this device, the status of the Lock\_Fbk feedback signal will change at different times, depending on the type of guard lock. This variability can be avoided by changing the value of the **Feedback Time** parameter, which is the maximum delay accepted by the "Guard\_Lock" operator before the Lock\_Fbk signal switches status following a request to activate the electromagnet. Clearly, the following condition must be met:

$$\text{Feedback Time} \geq \text{Electromagnet activation time}$$

This will now be explained using a practical example.



**Example of operation in the "no Gate" mode**

The guard lock used in the example continues to be locked when the electromagnet is not energised. Therefore the "Interlock spring" option must be selected.

The user unlocks the guard lock with the "SWITCH" block. The "LockOut" signal controls a "STATUS" SIL 1/PL c output block that controls the guard lock electromagnet, the status of which is detected by the "Lock\_fbk" input via the "LOCK FEEDBACK" input block. "Output1" indicates the status of the operations.

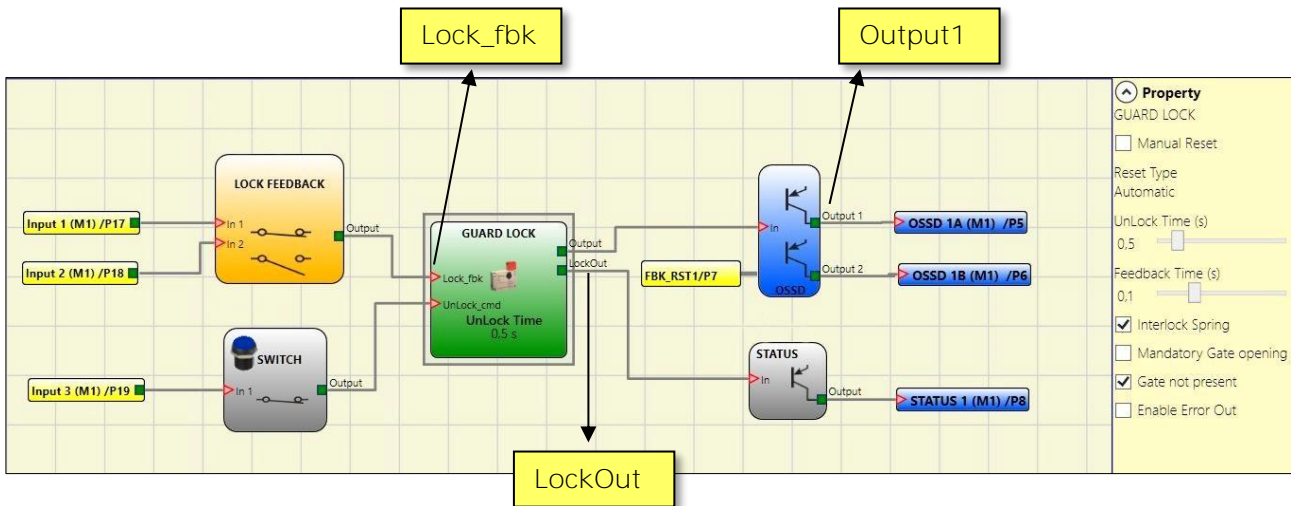

Figure 103 – Example of operation in the no Gate mode

➔ The Guard Lock operator parameters are shown on the right. On the left there is an example of an application diagram. The electromagnet feedback consists of two contacts, one normally closed and one normally open. When the electromagnet is energised the two contacts switch status.

Figure 104 shows the traces relative to the operation. These are described in detail below:

- (1) At this time the user requests to unlock the guard lock. The "COMMAND" signal switches from LL0 to LL1, and the "OUTPUT1" signal switches from LL1 to LL0.
- (2) At this time the electromagnet is activated with a delay of "Unlock Time", after the command is sent. This delay has been set to 0.5 seconds. The "ACTIV." signal switches from LL0 to LL1.
- (3) At this time the electromagnet is actually activated, 95ms after the command was sent. This delay is due to the technical characteristics of the electromagnet. In any case, 95ms is less than 100ms ("Feedback Time") and so no errors have occurred.
- (4) At this time the user releases the unlock command and the "COMMAND" signal switches from LL1 to LL0 as does the "ACTIV." activation signal.
- (5) At this time the electromagnet is actually deactivated, approx. 95ms after the command was sent due to the technical characteristics of the device. The guard lock is now locked.
- (6) As soon as the "Guard Lock" operator detects that the guard lock is locked, the "OUTPUT1" signal switches to LL1.

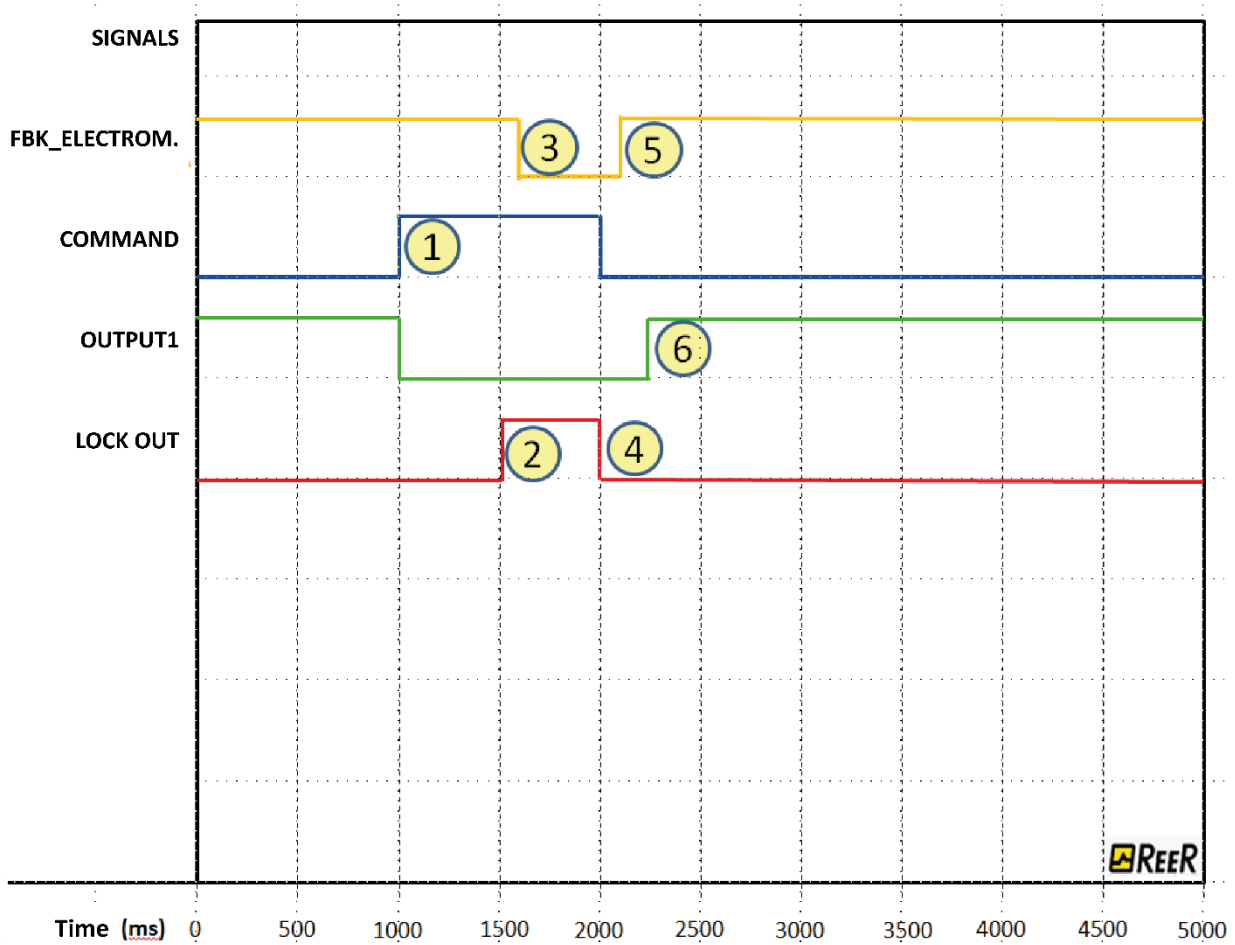

Figure 104 - Traces relative to “Guard Lock” block operation in the no gate mode.

Operation in the “with Gate” mode

In this case, the user must **NOT** select the “Gate not present” parameter.

The Gate input must always be connected to an “E-GATE” input element (see the E-GATE (safety gate device) section on page 138) that verifies the status of the door/gate.

The Lock\_Fbk input must always be connected to a “LOCK FEEDBACK” input element (see the LOCK FEEDBACK section on page 140) that verifies the status of the guard lock electromagnet.

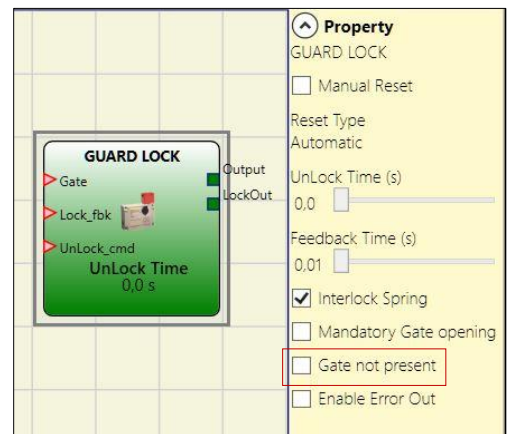

The UnLock\_cmd input can be connected freely in the diagram and determines the request to unlock the guard lock (when set to LL1).

The Output signal is LL1 (TRUE) if the safety guard is closed and locked. When an unlock command is applied to the UnLock\_cmd input, the Output signal is set to LLO and the guard lock is unlocked via the LockOut signal. The Output signal can also be set to LLO (FALSE) when error conditions are present (e.g. open door with guard lock locked, Feedback Time exceeding the maximum allowed, etc.).



When the UnLock\_cmd signal is detected, the LockOut signal unlocks the guard lock after the **UnLock Time**, a parameter that can be defined by the user.

The time after which the electromagnet is activated depends entirely on the technical/physical characteristics of the specific device and may therefore vary according to the type of guard lock used. Thus, since the LockOut signal controls the activation of this device, the status of the Lock\_Fbk feedback signal will change at different times, depending on the type of guard lock. This variability can be avoided by changing the value of the **Feedback Time** parameter, which is the maximum delay accepted by the "Guard\_Lock" operator before the Lock\_Fbk signal switches status following a request to activate the electromagnet. Clearly, the following condition must be met:

$$\text{Feedback Time} \geq \text{Electromagnet activation time}$$

This will now be explained using a practical example.

### Example of operation in the "with Gate" mode

In this example the user unlocks the guard lock with the "SWITCH" block. The "LockOut" signal controls an "STATUS" SIL 1/PL c output that controls the guard lock electromagnet, the status of which is detected by the "Lock\_fbk" input via the "LOCK FEEDBACK" input block. "Output1" indicates the status of the operations.

The status of the safety gate is monitored by the "Gate" input via the "E\_GATE" input block. The guard lock used in the example continues to be locked when the electromagnet is not energised. Therefore the "Interlock spring" option must be selected.

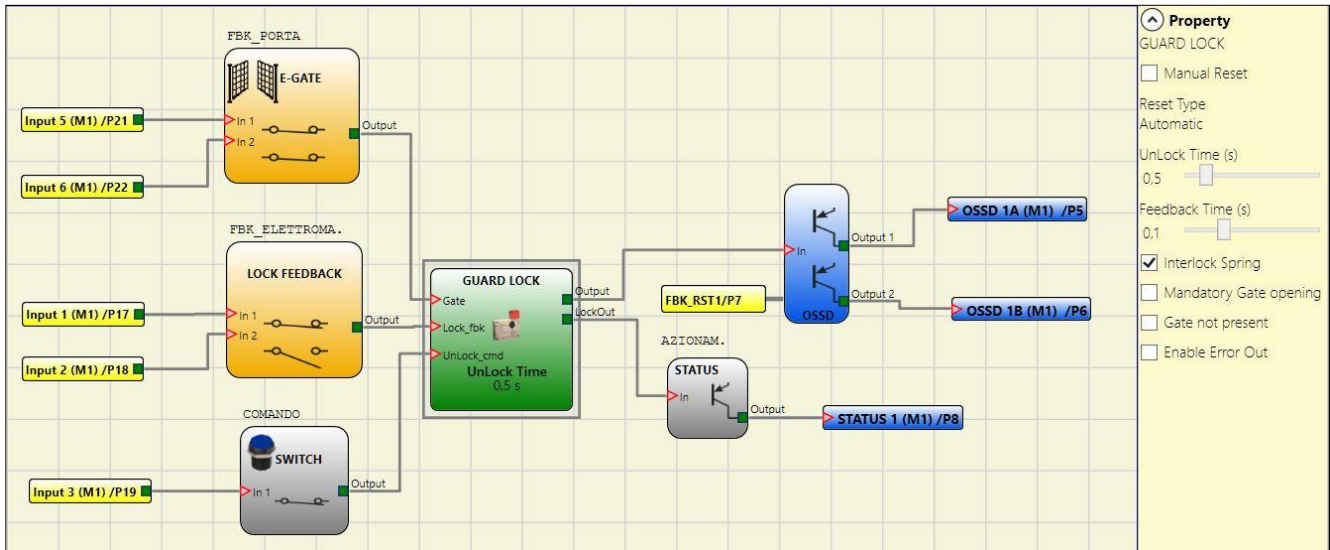

Figure 105 - Example of operation in the with Gate mode

➔ The Guard Lock operator parameters are shown on the right. On the left there is an example of an application diagram. The electromagnet feedback consists of two contacts, one normally closed and one normally open. When the electromagnet is energised the two contacts switch status. The gate feedback consists of two normally closed contacts.

Figure 106 shows the traces relative to the operation. These are described in detail below:

- (1) At this time the user requests to unlock the guard lock. The “COMMAND” signal switches from LLO to LL1, and the “OUTPUT1” signal switches from LL1 to LLO.
- (2) At this time the electromagnet is activated with a delay of "Unlock Time", after the command is sent. This delay has been set to 0.5 seconds. The “ACTIV.” signal switches from LLO to LL1.
- (3) At this time the electromagnet is actually activated, 95ms after the command was sent. This delay is due to the technical characteristics of the electromagnet. In any case, 95ms is less than 100ms ("Feedback Time") and so no errors have occurred.
- (4) At this time the guard lock is unlocked and the user opens the gate, the FBK\_GATE signal switches from LL1 to LLO.
- (5) At this time the user closes the gate and the FBK\_GATE signal thus switches from LLO to LL1.
- (6) At this time the user releases the unlock gate command. The “Guard Lock” detects the gate closed condition, via the FBK\_GATE signal, and sends a command to lock the guard lock. The “ACTIV.” signal switches from LL1 to LLO.
- (7) At this time the electromagnet is actually deactivated, approx. 95ms after the command was sent due to the technical characteristics of the device. The guard lock is now locked.
- (8) As soon as the “Guard Lock” operator detects that the guard lock is locked and the gate is closed, the “OUTPUT1” signal switches to LL1.

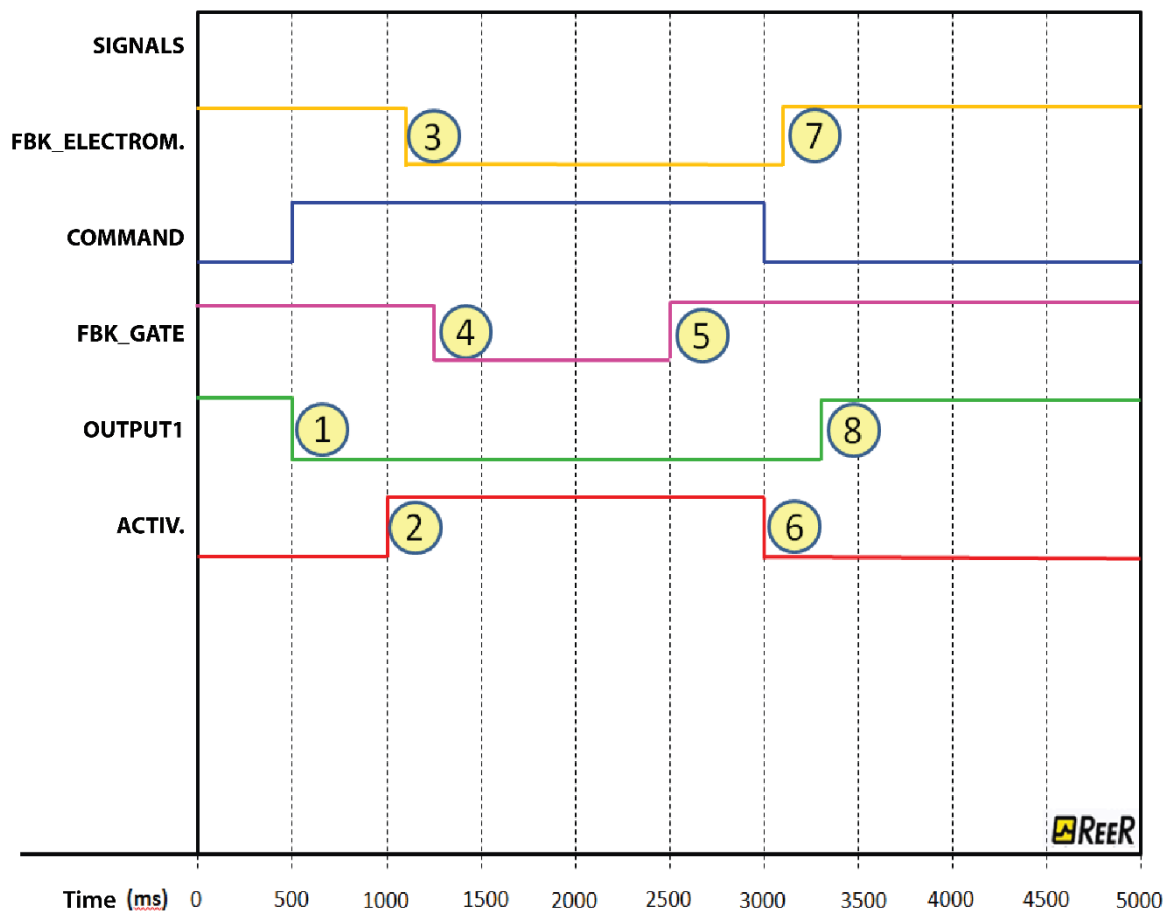

Figure 106 - Traces relative to “Guard Lock” block operation in the with gate mode.

**Operation in the "Mandatory Gate Opening" mode**

In this case, the user must NOT select the "Gate not present" parameter and must select the "Mandatory Gate opening" parameter.

The Gate input must always be connected to an "E-GATE" input element (see the E-GATE (safety gate device) section on page 138) that verifies the status of the door/gate. NB: IN THIS OPERATING MODE THE "GATE" INPUT MUST CONFIRM THE OPENING OF THE GATE.



The Lock\_Fbk input must always be connected to a "LOCK FEEDBACK" input element (see the LOCK FEEDBACK section on page 140) that verifies the status of the guard lock electromagnet.

The UnLock\_cmd input can be connected freely in the diagram and determines the request to unlock the guard lock (when set to LL1).

The Output signal is LL1 (TRUE) if the safety guard is closed and locked. When an unlock command is applied to the UnLock\_cmd input, the Output signal is set to LLO and the guard lock is unlocked via the LockOut signal.

The Output signal can also be set to LLO (FALSE) when error conditions are present (e.g. open door with guard lock locked, Feedback Time exceeding the maximum allowed, etc.).

When the UnLock\_cmd signal is detected, the LockOut signal unlocks the guard lock after the **UnLock Time**, a parameter that can be defined by the user.

The time after which the electromagnet is activated depends entirely on the technical/physical characteristics of the specific device and may therefore vary according to the type of guard lock used. Thus, since the the LockOut signal controls the activation of this device, the status of the Lock\_Fbk feedback signal will change at different times, depending on the type of guard lock. This variability can be avoided by changing the value of the **Feedback Time** parameter, which is the maximum delay accepted by the "Guard\_Lock" operator before the Lock\_Fbk signal switches status following a request to activate the electromagnet. Clearly, the following condition must be met:

$$Feedback\ Time \geq Electromagnet\ activation\ time$$

This will now be explained using a practical example.

**Example of operation in the "Mandatory Gate Opening" mode**

In this example the user unlocks the guard lock with the "SWITCH" block. The "LockOut" signal controls a "STATUS" SIL 1/PL c output that controls the guard lock electromagnet, the status of which is detected by the "LOCK FEEDBACK" input block. "Output1" indicates the status of the operations.

The status of the safety gate is monitored by the "Gate" input via the "E\_GATE" input block, the "Mandatory Gate opening" parameter is selected.

The guard lock used in the example continues to be locked when the electromagnet is not energised. Therefore the "Interlock spring" option must be selected.

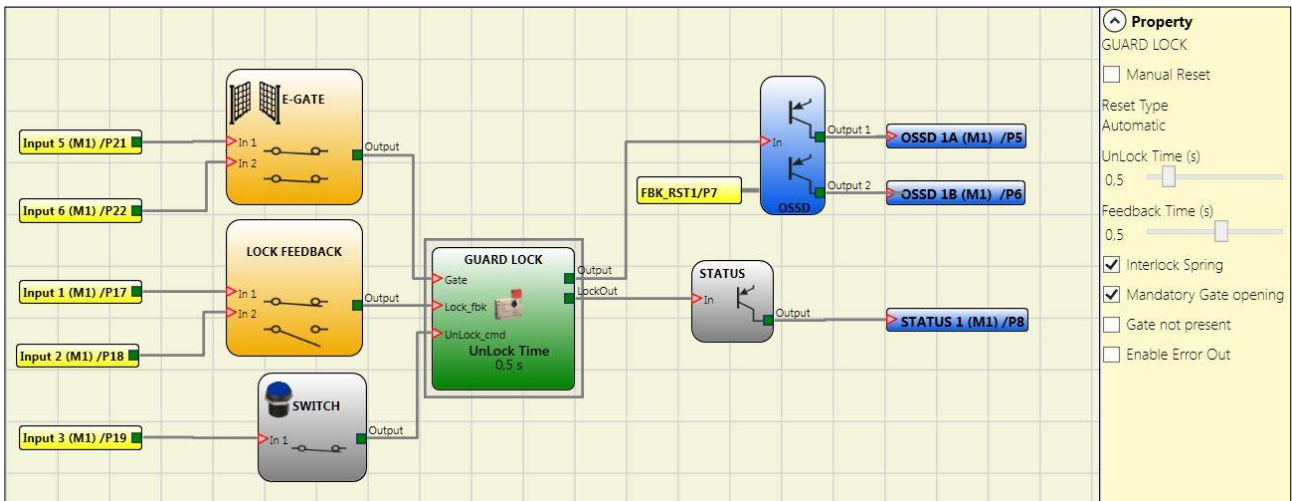

Figure 107 Example of operation in the Mandatory Gate Opening mode

➔ The Guard Lock operator parameters are shown on the right. On the left there is an example of an application diagram. The electromagnet feedback consists of two contacts, one normally closed and one normally open. When the electromagnet is energised the two contacts switch status. The gate feedback consists of two normally closed contacts.

Figure 108 shows the traces relative to the operation. These are described in detail below:

- (1) At this time the user requests to unlock the guard lock. The "COMMAND" signal switches from LL0 to LL1, and the "Output1" signal switches from LL1 to LL0.
- (2) At this time the electromagnet is activated with a delay of "Unlock Time", after the command is sent. This delay has been set to 0.5 seconds. The "ACTIV." signal switches from LL0 to LL1.
- (3) At this time the electromagnet is actually activated, 95ms after the command was sent. This delay is due to the technical characteristics of the electromagnet. In any case, 95ms is less than 100ms ("Feedback Time") and so no errors have occurred.
- (4) At this time the guard lock is unlocked and the user opens the gate. The FBK\_GATE signal switches from LL1 to LL0.
- (5) At this time the user closes the gate and the FBK\_GATE signal thus switches from LL0 to LL1.
- (6) At this time the user releases the unlock gate command. The "Guard Lock" detects the gate closed condition, via the FBK\_GATE signal, and sends a command to lock the guard lock. The "ACTIV." signal switches from LL1 to LL0.
- (7) At this time the electromagnet is actually deactivated, approx. 95ms after the command was sent due to the technical characteristics of the device. The guard lock is now locked.

- (8) As soon as the “Guard Lock” operator detects that the guard lock is locked and the gate is closed, the “Output1” signal switches to LL1.

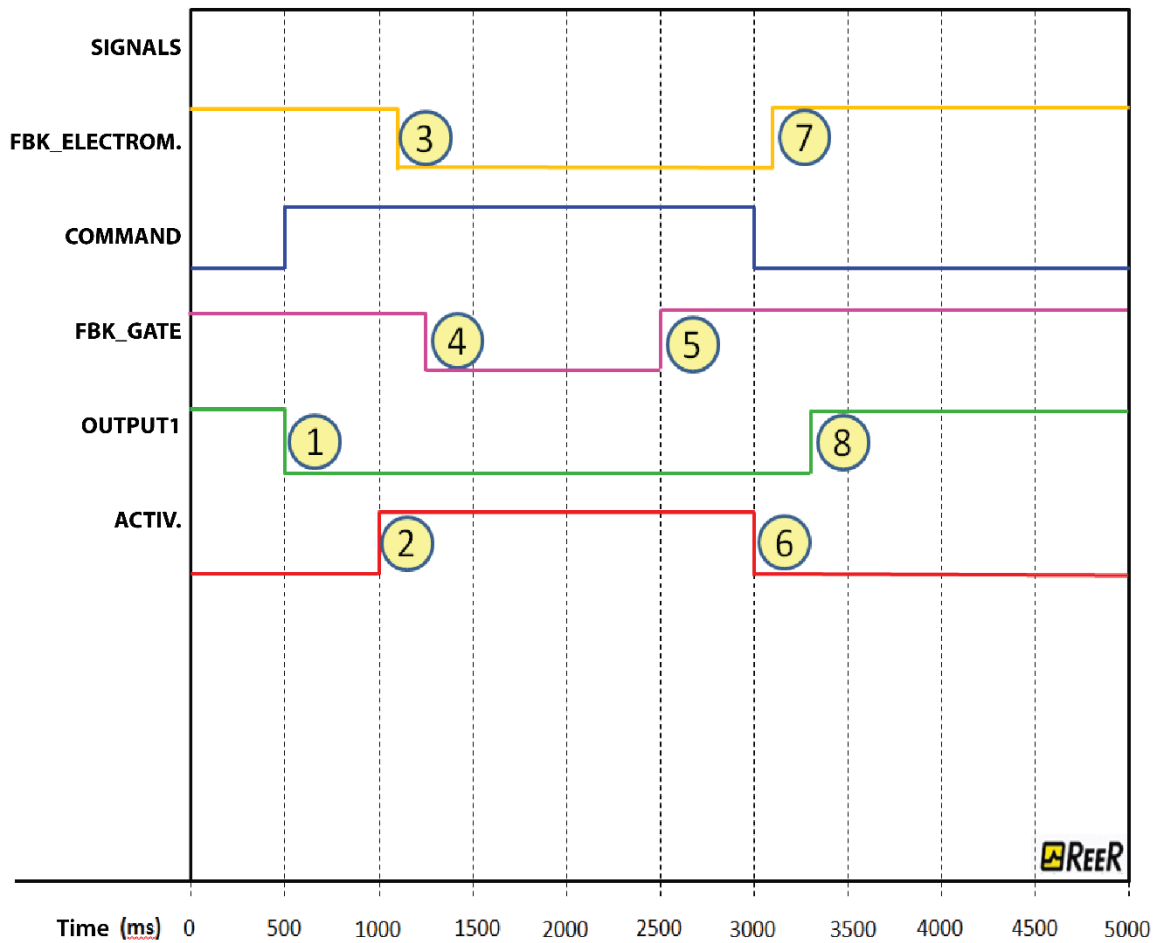

Figure 108 - Traces relative to “Guard Lock” block operation in the “Mandatory gate opening mode”.

In “Mandatory gate opening” mode, the “Guard\_lock” operator indicates an error condition if it does not detect that the gate has been opened following a request to unlock the guard lock. This concept is highlighted in the figure below (Figure 109). In this case, the “Enable Error out” option has been selected in the diagram in Figure 107, so that the error is shown in the graph.

As previously described, the operator requests unlocking of the guard lock, but the door is never opened, and this condition is indicated by the “FBK\_GATE” signal, which stays at LL1. Thus, when the guard lock unlocking/locking cycle ends, at time “E”, the “Guard\_Lock” operator switches the status of the “ERROR” signal from LL0 to LL1.

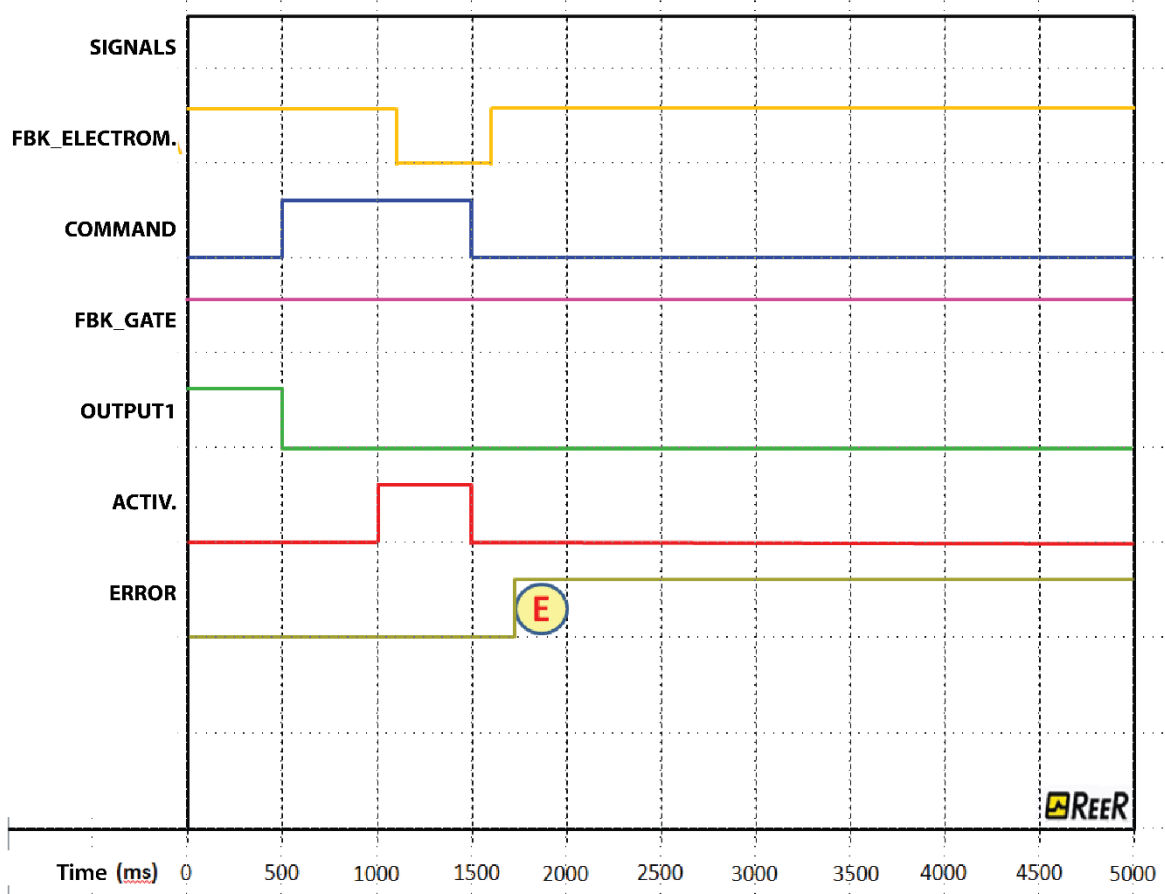

Figure 109 – Example of possible error condition in "Mandatory gate opening" mode. In this case the error condition is generated because the gate has not been opened, even though a request has been sent to unlock/lock the guard lock.

COUNTER OPERATORS

**COUNTER (max number = 16)**

COUNTER operator is a pulse counter that sets output Q to 1 (TRUE) as soon as the desired count is reached.

There are 3 operating modes:

- 1) AUTOMATIC
- 2) MANUAL
- 3) AUTOMATIC + MANUAL

Following are illustrated 3 examples for each operating mode. The counter value is 6 for all examples.

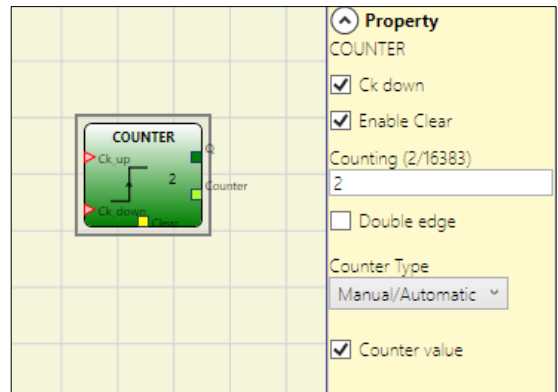

- 1) AUTOMATIC: The counter generates a pulse duration equal to  $2 \times T_{cycle}$  (this value is indicated in the REPORT) as soon as the set count is reached. If the CLEAR pin is not enabled this is the default mode.



- 2) MANUAL: The counter leads to 1 (TRUE) the output Q as soon as it reaches the set count. The output Q goes to 0 (FALSE) when the signal CLEAR is activated.

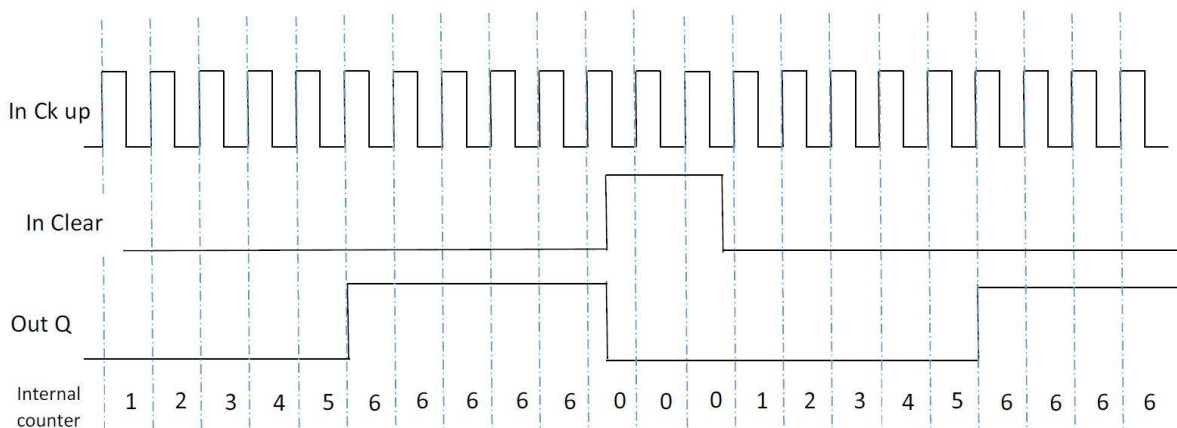

3) MANUAL/AUTOMATIC: The counter generates a pulse duration equal to the system response time as soon as the set count is reached. If the CLEAR signal is activated, the internal count goes back to 0.

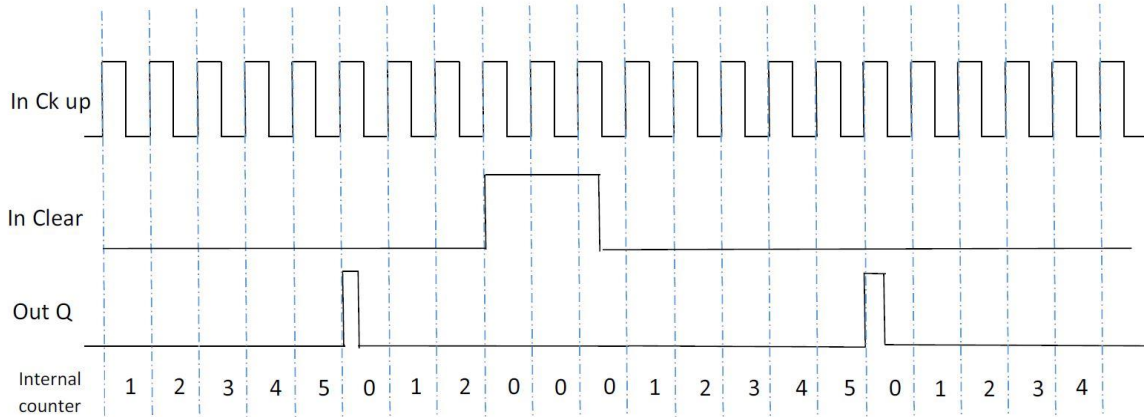

**Parameters**

**Enable Clear:** If selected enables the signal CLEAR in order to restart the counter setting output Q to 0 (FALSE). It also offers the possibility to select the operation mode.

**Counter type:** If ENABLE CLEAR is not selected operation is AUTOMATIC (*example 1*).

If ENABLE CLEAR is selected, operation is selectable between MANUAL (*example 2*) or MANUAL/AUTOMATIC (*example 3*).

**Ck down:** Enables counting down.

**Two-way:** If selected it enables counting on both the rising and falling edges.

**Counter value:** If selected, it allows the current counter value to be outputted from the delay block. This output can be sent as input to one or more COUNTER COMPARATOR blocks.

**COUNTER COMPARATOR**

Gets as an input the counter value of an operator COUNTER and compares the received value with a threshold set by the user.

The OUT output will be 0 (FALSE) as long as the COUNTER value is lower than the threshold value. The OUT output will be set to 1 (TRUE) for COUNTER values equal to or higher than the threshold value.

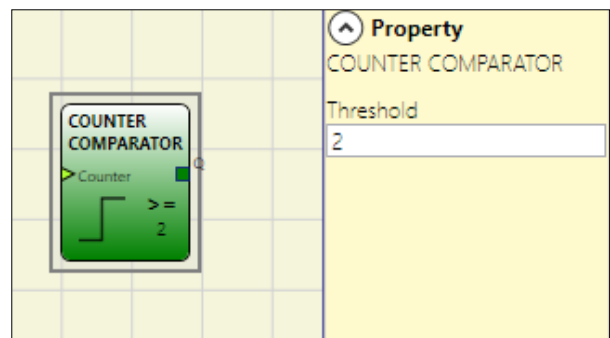

➔ The COUNTER COMPARATOR operator can only be connected to the Counter value of a COUNTER operator. Multiple COUNTER COMPARATOR can be also connected to a single COUNTER operator.



TIMER OPERATORS (max number = 32 with MOSAIC M1, 48 with MOSAIC M1S, MOSAIC M1S COM)

TIMER operators allow you to generate a signal (TRUE or FALSE) for a user-definable period.

**MONOSTABLE**

The MONOSTABLE operator generates a level 1 (TRUE) output activated by the rising edge of the input and remains in this condition for the set time.

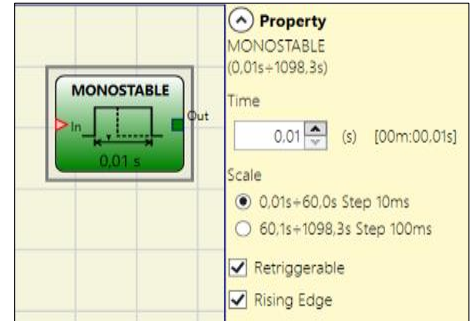

**Parameters**

**Time:** The delay can be set to between 10 ms and 1098,3 s.

**Scale:** The user can choose two different scales for the time *T* to be set.

- 10 ms...60 s, step 10 ms
- 60,1 s...1098,3 s, step 100 ms

**Rising edge:** If selected, the output is set to 1 (TRUE) on the input signal's rising edge where it remains for the set time, which can be extended for as long as the input stays at 1 (TRUE).

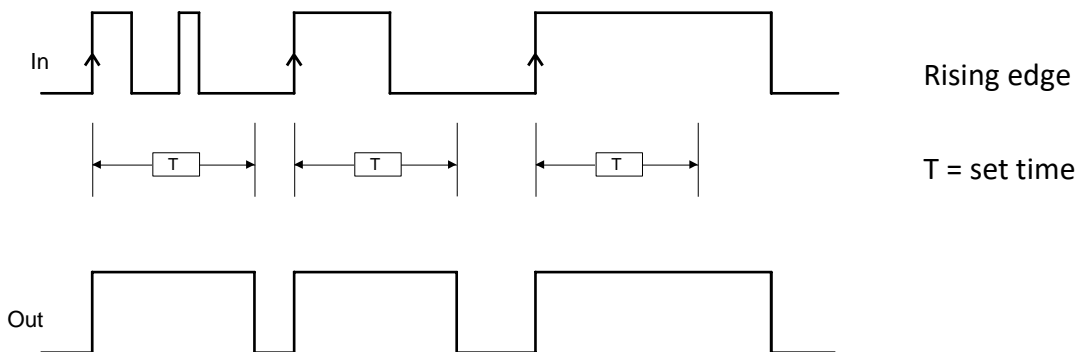

If not selected the logic is inverted, the output is set to 0 (FALSE) on the input signal's falling edge, where it remains for the set time, which can be extended for as long as the input stays at 0 (FALSE).

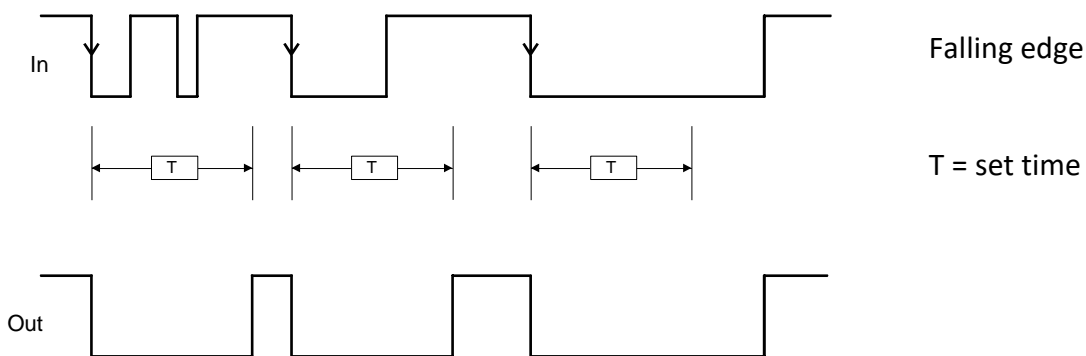

**Retriggerable:** If selected the time is reset each time the input status changes.

MONOSTABLE\_B

This operator generates a level 1 (TRUE) output activated by the rising/falling edge of the input and remains in this condition for the set time  $t$ .

Parameters

**Time:** The delay can be set to between 10 ms and 1098,3 s.

**Scale:** The user can choose two different scales for the time  $T$  to be set.

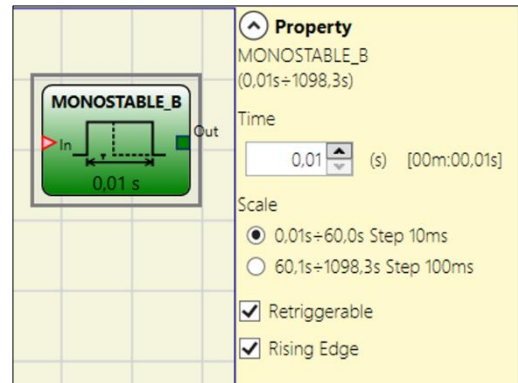

- 10 ms...60 s, step 10 ms
- 60,1 s...1098,3 s, step 100 ms

Rising edge:

- If selected provides a level 1 (TRUE) in the OUT output if a rising edge is detected on the IN input.
- If not selected the logic is inverted, the OUT output is set to 0 (FALSE) on the IN signal's falling edge, where it remains for the set time.

➔ Unlike the MONOSTABLE operator, the Out output of MONOSTABLE\_B does not maintain a level 1 (TRUE) for a time which exceeds the set period  $T$ .

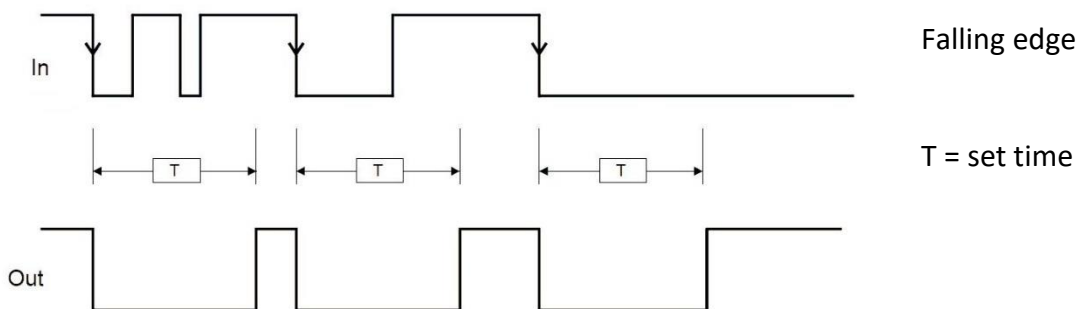
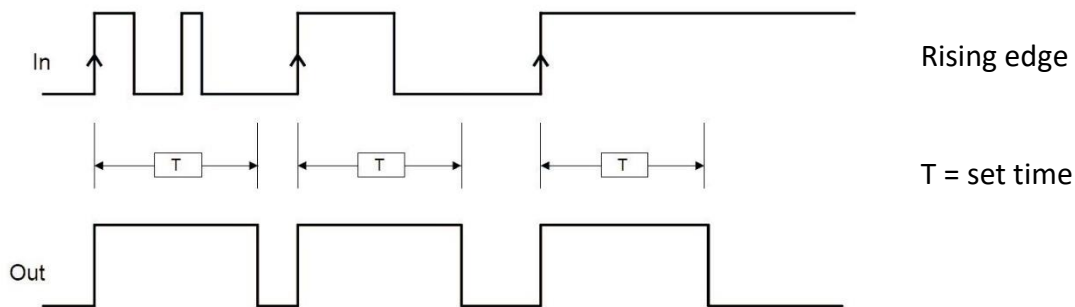

**Retriggerable:** If selected the time is reset each time the input status changes.

## PASSING MAKE CONTACT

In the PASSING MAKE CONTACT operator the output follows the signal on the input. However, if this is 1 (TRUE) for longer than the set time, the output changes to 0 (FALSE). When there is an input falling edge, the timer is cleared.

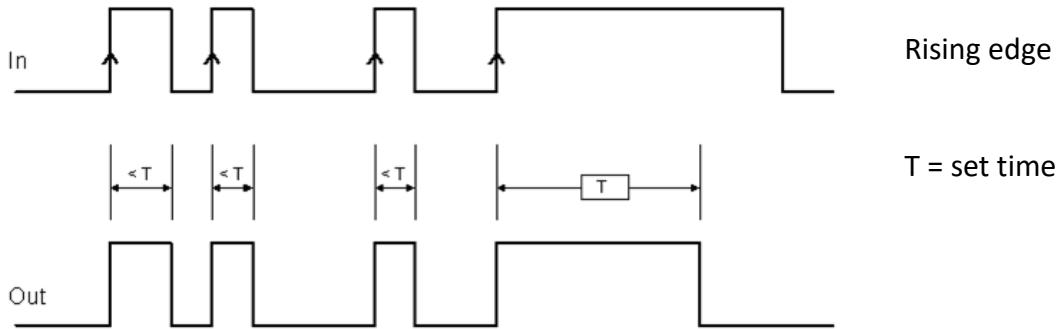
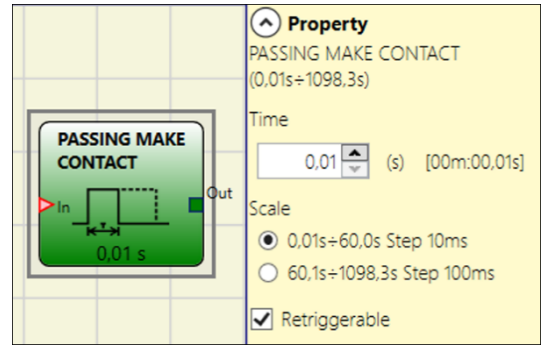

### Parameters

**Time:** The delay can be set to between 10 ms and 1098,3 s.

**Scale:** The user can choose two different scales for the time  $T$  to be set.

- 10 ms...60 s, step 10 ms
- 60,1 s...1098,3 s, step 100 ms

**Retriggerable:** If selected the time is not reset when there is an input falling edge. The output stays 1 (TRUE) for all the selected time. When there is a new input rising edge, the timer restart again.

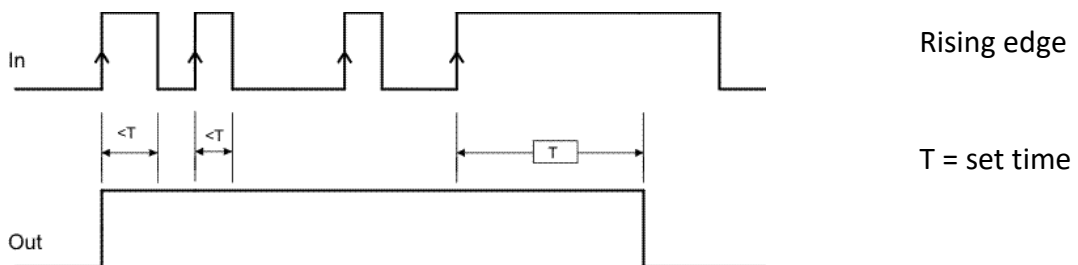

**DELAY**

DELAY operator applies a delay to a signal by setting the output to 1 (TRUE) after the set time, against a change in the level of the input signal.

**Parameters**

**Time:** The delay can be set to between 10 ms and 1098,3 s.

**Scale:** The user can choose two different scales for the time *T* to be set.

- 10 ms...60 s, step 10 ms
- 60,1 s...1098,3 s, step 100 ms

**Rising edge:** If selected, the delay starts on the input signal's rising edge at the end of which the output changes to 1 (TRUE) if the input is 1 (TRUE) where it remains for as long as the input stays at 1 (TRUE).

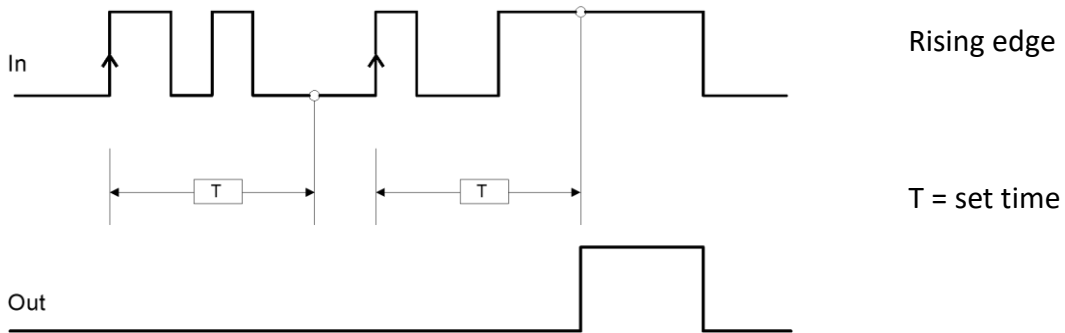
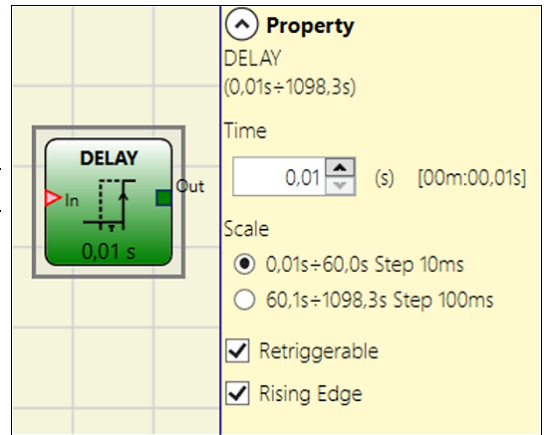

If not selected the logic is inverted, the output is set to 1 (TRUE) on the input signal's falling edge, the delay starts on the input signal's falling edge, at the end of the set time the output changes to 0 (FALSE) if the input is 0 (FALSE) otherwise it remains 1 TRUE.

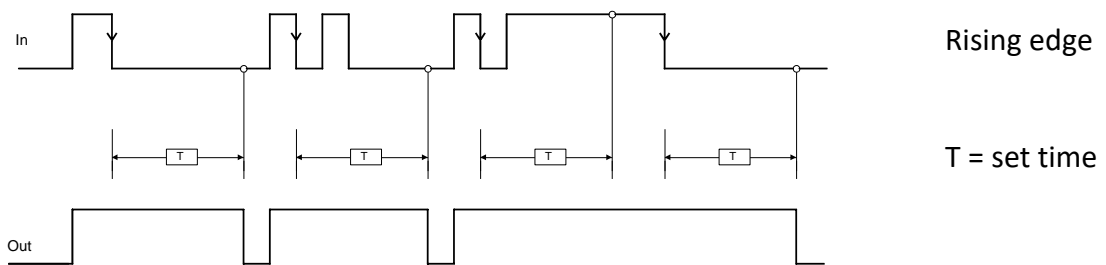

**Retriggerable:** If selected the time is reset each time the input status changes.

**LONG DELAY**

The LONG DELAY operator allows to apply a delay (up to more than 15 hours) to a signal bringing to 1 (TRUE) the Out output after the set time, in case of a level variation of the signal on the In input.

**Parameters**

**Time:** The delay can be set from 0.5 s to 54915 s.

**Scale:** The user can choose two different scales for the time *T* to be set.

- 0,5 s...3000 s, step 0,5 s
- 3005 s...54915 s, step 5 s

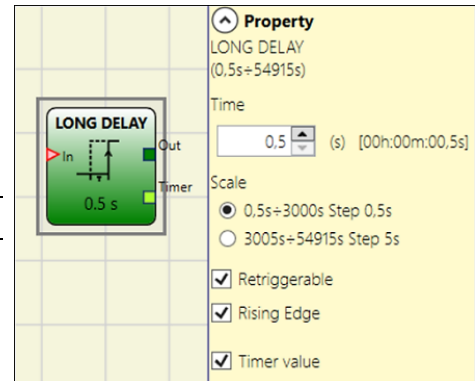

**Rising edge:** If selected, the delay starts on the input signal's rising edge at the end of which the output changes to 1 (TRUE) if the input is 1 (TRUE) where it remains for as long as the input stays at 1 (TRUE).

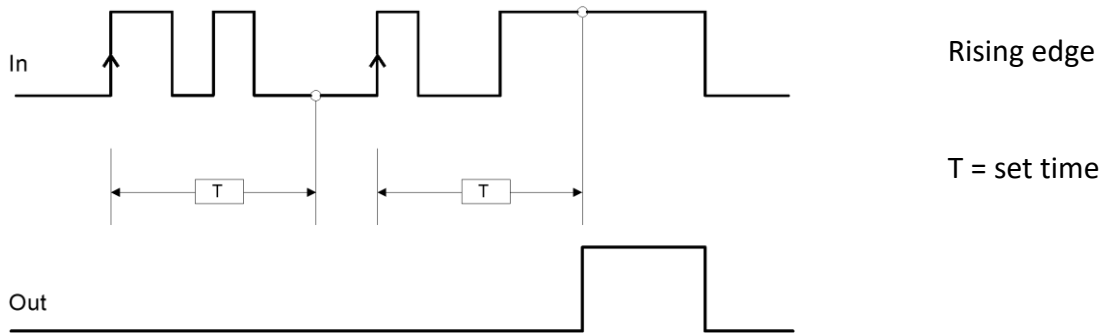

If not selected the logic is inverted, the output is set to 1 (TRUE) on the input signal's falling edge, at the end of the set time the output changes to 0 (FALSE) if the input is 0 (FALSE) otherwise it remains 1 TRUE.

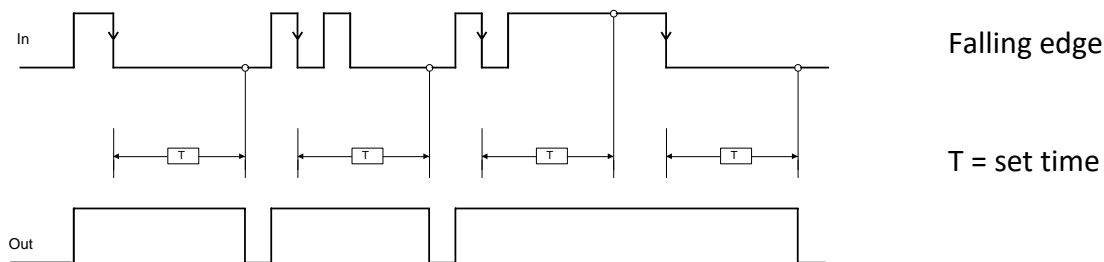

**Retriggerable:** If selected the time is resetted every time the input status changes.

**Timer value:** When selected the actual value of the timer is available as output which can be sent as input to a DELAY COMPARATOR block.

**DELAY COMPARATOR**

This operator compares the timer value outputted by a LONG DELAY timer and connected to the DELAY COMPARATOR “Timer” input with the set threshold value.

The OUT output will be 0 (FALSE) as long as the timer value is lower than the threshold value. The OUT output will be set to 1 (TRUE) for Timer values equal to or higher than the threshold value.

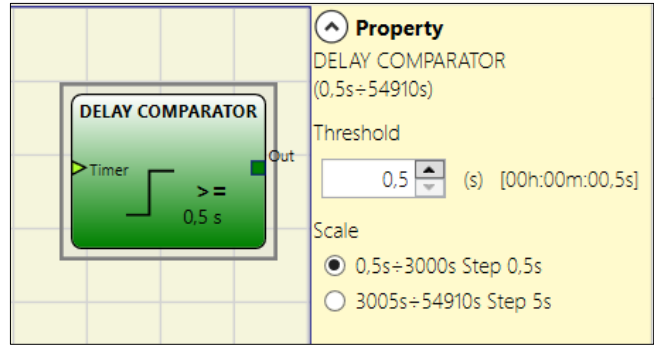

**Parameters**

**Threshold:** The threshold can be set from 0,5 s to 54910 s.

**Scale:** The user can choose two different scales for the time *T* to be set.

- 0,5 s...3000 s, step 0,5 ms
- 3005 s...54910 s, step 5 s

➔ The Delay Comparator operator can only be connected to the Timer value output of a LONG DELAY operator. Multiple DELAY COMPARATORS can be connected to each LONG DELAY operator.

**DELAY LINE**

This operator applies a delay to a signal by setting the “Out” output to 0 (FALSE) after the set time when a falling edge is detected on the “In” signal.

If “In” returns to 1(TRUE) before the end of the set time the “Out” output still generates a negative impulse lasting approximately twice the system response time and delayed by the set time.

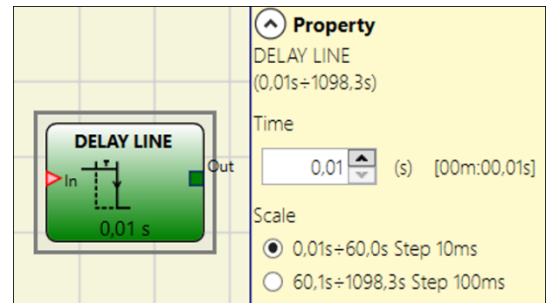

**Parameters**

**Time:** The delay can be set to between 10 ms and 1098,3 s.

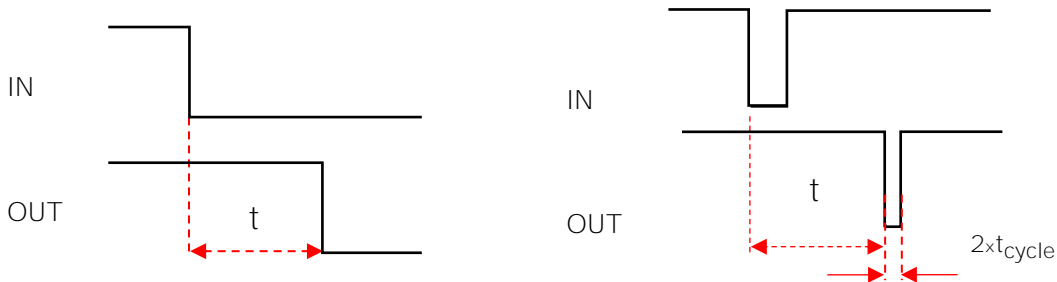

**Scale:** The user can choose two different scales for the time *T* to be set.

- 10 ms...60 s, step 10 ms
- 60 s...1098,3 s, step 100 ms

- ➔ Unlike the DELAY operator, the DELAY LINE operator does not filter any interruptions in the IN input which are shorter than the set time.
- ➔ This operator is recommended when using delayed OSSD (the OSSD must be programmed with RESTART MANUAL).

### LONG DELAY LINE

This operator applies a delay to a signal by setting the “Out” output to 0 (FALSE) after the set time when a falling edge is detected on the “In” signal.

If In returns to 1(TRUE) before the end of the set time the “Out” output still generates a negative impulse lasting approximately twice the system response time and delayed by the set time.

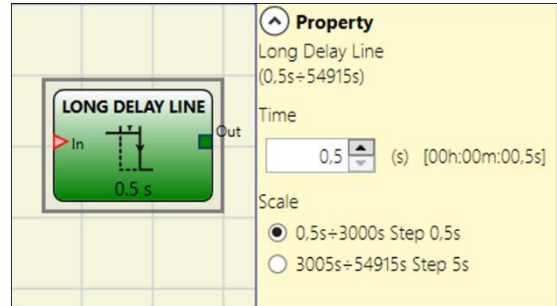

### Parameters

**Time:** The delay can be set from 0.5 s to 54915 s.

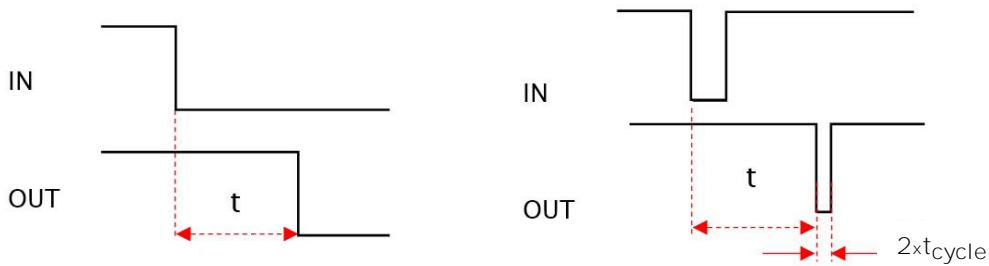

**Scale:** The user can choose two different scales for the time  $T$  to be set.

- 0,5 s...3000 s, step 0,5 s
- 3005 s...54915 s, step 5 s

- ➔ Unlike the DELAY operator, the LONG DELAY LINE operator does not filter out any interruptions to the IN input that are shorter than the set time.
- ➔ This operator is useful when using delayed OSSDs (the OSSD must be programmed with MANUAL RESTART).

CLOCKING

The CLOCKING operator generates a square wave output which period is set by the user. The output is enabled if the “En” input is set to 1 (TRUE). Clocking has up to 7 inputs to control output Duty Cycle.

Parameters

**Time:** The period can be set to between 100 ms and 1098,3 s.

**Scale:** The user can choose two different scales for the time *T* to be set.

- 100 ms...60 s, step 10 ms
- 60,1 s...1098,3 s, step 100 ms

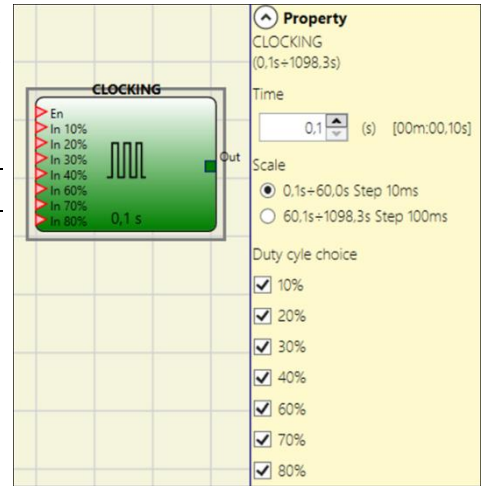

**Duty cycle selection:** Up to 7 inputs can be selected for 7 different output signal duty cycles. Depending on the active input, the OUT clock signal has its corresponding duty cycle. EN input must always be to 1 (TRUE).

Refer to the table below for all possible values of Duty cycle selectable by the user.

DUTY CYCLE CHOICE								
EN	10%	20%	30%	40%	60%	70%	80%	OUT
0	0	0	0	0	0	0	0	0
1	0	0	0	0	0	0	0	50%
1	1	0	0	0	0	0	0	10%
1	0	1	0	0	0	0	0	20%
1	0	0	1	0	0	0	0	30%
1	0	0	0	1	0	0	0	40%
1	0	0	0	0	1	0	0	60%
1	0	0	0	0	0	1	0	70%
1	0	0	0	0	0	0	1	80%
1	1	0	0	0	0	0	1	90%

- ➔ The circuit upstream clocking operator must ensure the presence of only one input signal in addition to enable EN (excluded the pair 10% 80%).
- ➔ The presence on EN input of high level (TRUE), generates an output signal with a duty cycle = 50%.

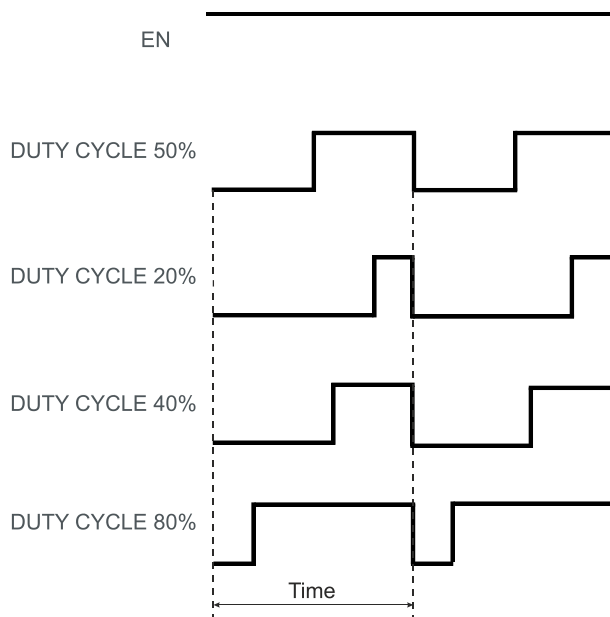



MUTING FUNCTION

*The Muting function generates a temporary, automatic interruption of electro-sensitive protective device (ESPE) operation in order to permit normal transit of material through the guarded opening. In other words, when the system recognizes the material and distinguishes between this and any operator (in a potentially dangerous situation), it is enabled to bypass the safety device temporarily, allowing the material to pass through the guarded opening.*

MUTING OPERATORS (max number = 4 with MOSAIC M1, 8 with MOSAIC M1S/MOSAIC M1S COM)

"Concurrent" MUTING

*The activation of the Muting function occurs following interruption of the sensors S1 and S2 beam (the order does not matter) within a time range from 2s and 5s chosen by the operator (or S3 and S4 with material that is moving in the direction opposite).*

The MUTING operator with "Concurrent" logic performs muting of the input signal through sensor inputs S1, S2, S3 and S4.

➔ **Preliminary condition:** The Muting cycle can only start if all the sensors are 0 (FALSE) and inputs are 1 (TRUE) (safety curtain free).

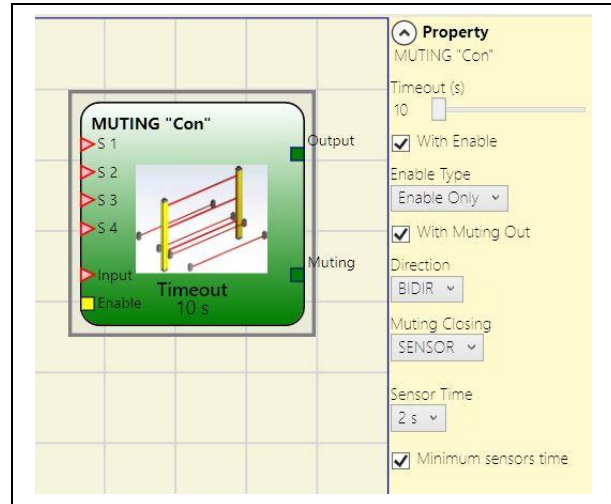

Parameters

**Timeout (sec):** Sets the time, between 10 secs and unlimited, within which the Muting cycle must end. If the cycle is not complete at the end of this time, Muting is immediately discontinued.

**With Enable:** When checked let the user the possibility of enabling or not enabling the Muting function. Otherwise the Muting function is always enabled.

**Enable Type:**

There are two Enable modes: Enable/Disable and Enable Only.

- If **"Enable/Disable"** is selected the Muting cycle cannot start if Enable is stucked at 1 (TRUE) or 0 (FALSE). It is only activated with a rising edge of the signal. On the other hand the falling edge disables Muting regardless of the current condition.
- If **"Enable Only"** is selected the Muting function cannot be disabled. It is mandatory to set the **"Enable" input to 0 (FALSE) in order to reset this command for a new Muting cycle**.

**Direction:** This let the user to choose the order in which the sensors are occupied. If set to BIDIR they can be occupied in both directions, from S1&S2 to S3&S4 and from S3&S4 to S1&S2, if set to UP they can be occupied from S1&S2 to S3&S4 and if set to DOWN from S3&S4 to S1&S2.

**Muting Closing:** There are two types, CURTAIN and SENSOR. If you select CURTAIN muting closes when the input signal rises, if you select SENSOR it closes when the third sensor has been cleared.

Select CURTAIN

S1	S2	Input	S3	S4	Muting
0	0	1	0	0	0
1	0	1	0	0	0
1	1	1	0	0	1
1	1	X	0	0	1
1	1	X	1	1	1
0	0	0	1	1	1
0	0	1	1	1	0
0	0	1	0	0	0

Muting active

Select SENSOR

S1	S2	Input	S3	S4	Muting
0	0	1	0	0	0
1	0	1	0	0	0
1	1	1	0	0	1
1	1	X	0	0	1
1	1	X	1	1	1
0	0	0	1	1	1
0	0	1	1	1	1
0	0	1	0	1	0
0	0	1	0	0	0

Muting active

**Blind Time:** Only with Muting Close=Curtain, **blind time** is enabled when it is known that after a complete transition of the pallet (muting cycle close) some protruding objects could still occupy the light curtain and send the input to 0 (FALSE). During blind time the input remains 1 (TRUE). Blind Time can range from 250 ms to 1 second.

**Sensors Time:** Sets the maximum time (between 2 and 5 seconds) between activating two muting sensors.

**Minimum sensors time:** If selected, allows the activation of Muting cycle only if a time  $\geq 150$ ms elaps between the activation of the sensor 1 and sensor 2 (or sensor 4 and 3).

MUTING "L"

The activation of the Muting function occurs following interruption of the sensors S1 and S2 beam (the order does not matter) within a time range from 2s and 5s decided by the operator. The state of the Muting ends after the liberation of the guarded opening.

The MUTING operator with "L" logic performs muting of the input signal through sensor inputs S1 and S2.

➔ Preliminary condition: The Muting cycle can only start if S1 and S2 are 0 (FALSE) and the input = 1 (TRUE) (safety curtain free).

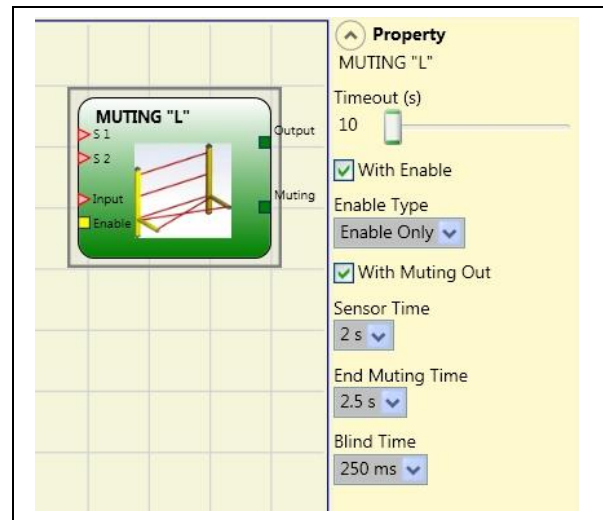

Parameters

**Timeout (sec):** Sets the time, between 10 secs and unlimited, within which the Muting cycle must end. If the cycle is not complete at the end of this time, Muting is immediately discontinued.

**With Enable:** When checked let the user the possibility of enabling or not enabling the Muting function. Otherwise the Muting function is always enabled.

**Enable Type:**

There are two Enable modes: Enable/Disable and Enable Only.

- If **“Enable/Disable”** is selected the Muting cycle cannot start if Enable is stucked at 1 (TRUE) or 0 (FALSE). It is only activated with a rising edge of the signal. On the other hand the falling edge disables Muting regardless of the current condition.
- If **“Enable Only”** is selected the Muting function cannot be disabled. It is mandatory **to set the “Enable” input to 0 (FALSE) in order to reset this command for a new Muting cycle.**

**Sensors Time:** Sets the maximum time (between 2 and 5 seconds) between activating two muting sensors.

**End of Muting time:** sets the maximum time (from 2.5 to 6 seconds) that must elapse between the release of the first sensor and the release of guarded opening. The end of this time determines the end of the Muting function.

**Blind Time:** enabled when it is known that after a complete transition of the pallet (muting cycle close) some protruding objects could still occupy the light curtain and send the input to 0 (FALSE). During blind time the input remains 1 (TRUE). Blind Time can range from 250 ms to 1 second.

**“Sequential” MUTING**

*The activation of the Muting function occurs following sequential interruption of the sensors S1 and S2, subsequently S3 and S4 sensors (without time limit). If the pallet proceeds in the opposite direction the correct sequence is: S4, S3, S2, S1.*

The MUTING operator with “Sequential” logic performs muting of the input signal through sensor inputs S1, S2, S3 and S4.

➔ **Preliminary condition:** The Muting cycle can only start if all the sensors are 0 (FALSE) and the input = 1 (TRUE) (safety curtain free).

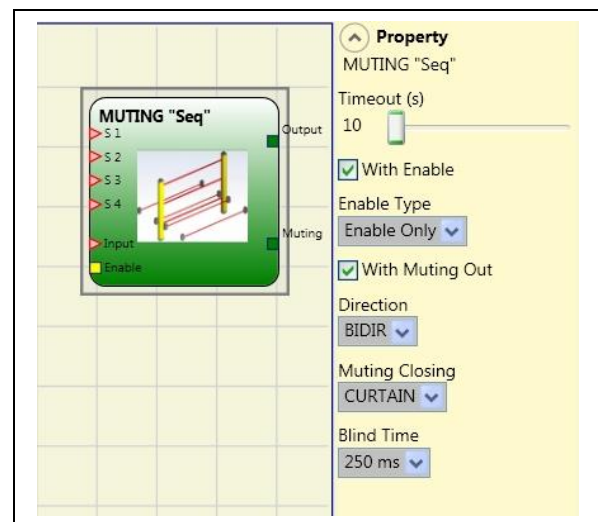

**Parameters**

**Timeout (sec):** Sets the time, between 10 secs and unlimited, within which the Muting cycle must end. If the cycle is not complete at the end of this time, Muting is immediately discontinued.

**With Enable:** When checked let the user the possibility of enabling or not enabling the Muting function. Otherwise the Muting function is always enabled.

**Enable Type:**

There are two Enable modes: Enable/Disable and Enable Only.

- If **“Enable/Disable”** is selected the Muting cycle cannot start if Enable is stucked at 1 (TRUE) or 0 (FALSE). It is only activated with a rising edge of the signal. On the other hand the falling edge disables Muting regardless of the current condition.
- If **“Enable Only”** is selected the Muting function cannot be disabled. It is mandatory **to set the “Enable” input to 0 (FALSE) in order to reset this command for a new Muting cycle.**

**Direction:** This let the user to choose the order in which the sensors are occupied. If set to BIDIR they can be occupied in both directions, from S1 to S4 and from S4 to S1, if set to UP they can be occupied from S1 to S4 and if set to DOWN from S4 to S1.

**Muting Closing:** There are two types, CURTAIN and SENSOR. If you select CURTAIN muting closes when the input signal rises, if you select SENSOR it closes when the third sensor has been cleared.

Select CURTAIN

S1	S2	Input	S3	S4	Muting
0	0	1	0	0	0
1	0	1	0	0	0
1	1	1	0	0	1
1	1	X	0	0	1
1	1	X	1	0	1
1	1	X	1	1	1
0	1	X	1	1	1
0	0	0	1	1	1
0	0	1	1	1	0
0	0	1	0	1	0
0	0	1	0	0	0

Muting active

Select SENSOR

S1	S2	Input	S3	S4	Muting
0	0	1	0	0	0
1	0	1	0	0	0
1	1	1	0	0	1
1	1	X	0	0	1
1	1	X	1	0	1
1	1	X	1	1	1
0	1	X	1	1	1
0	0	0	1	1	1
0	0	1	1	1	1
0	0	1	0	1	0
0	0	1	0	0	0

Muting active

**Blind Time:** Only with Muting Close=Curtain, **blind time** is enabled when it is known that after a complete transition of the pallet (muting cycle close) some protruding objects could still occupy the light curtain and send the input to 0 (FALSE). During blind time the input remains 1 (TRUE). Blind Time can range from 250 ms to 1 second.

MUTING "T"

The activation of the Muting function occurs following interruption of the sensors S1 and S2 beam (the order does not matter) within a time range from 2s and 5s decided by the operator. The state of the Muting ends after the liberation of at least one of the two sensors.

The MUTING operator with "T" logic performs muting of the input signal through sensor inputs S1 and S2.

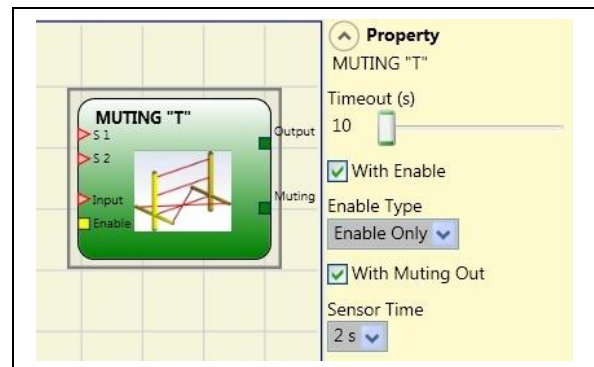

➔ Preliminary condition: The Muting cycle can only start if S1 and S2 are 0 (FALSE) and the inputs are 1 (TRUE) (safety curtain free).

Parameters

**Timeout (sec):** Sets the time, between 10 secs and unlimited, within which the Muting cycle must end. If the cycle is not complete at the end of this time, Muting is immediately discontinued.

**With Enable:** When checked let the user the possibility of enabling or not enabling the Muting function. Otherwise the Muting function is always enabled.

**Enable Type:**

There are two Enable modes: Enable/Disable and Enable Only.

- If **“Enable/Disable”** is selected the Muting cycle cannot start if Enable is stucked at 1 (TRUE) or 0 (FALSE). It is only activated with a rising edge of the signal. On the other hand the falling edge disables Muting regardless of the current condition.
- If **“Enable Only”** is selected the Muting function cannot be disabled. It is mandatory **to set the “Enable” input to 0 (FALSE) in order to reset this command for a new Muting cycle.**

**Sensors Time:** Sets the maximum time (between 2 and 5 seconds) between activating two muting sensors.

**MUTING OVERRIDE (max number = 4)**

*The OVERRIDE function must be used when the machine stops due to incorrect Muting activation sequences with the material obstructing the guarded opening. This function activates the OSSD outputs making it possible to remove the material that is obstructing the guarded opening.*

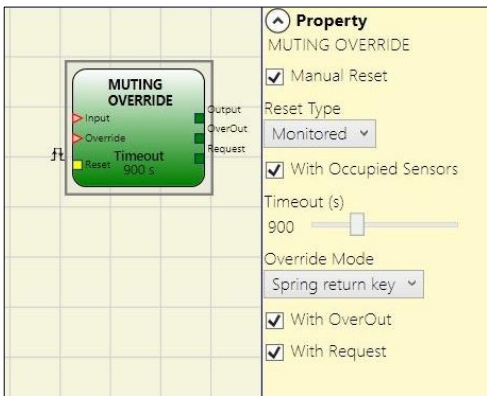

The operator must be connected after the Muting operator (Muting OUTPUT directly to the Override INPUT). It permits override of the directly connected Muting Input.

Override can be activated only if Muting is not active (INPUT=0) and at least one Muting sensor is occupied (or the safety curtain is occupied).

Override ends when the light curtain and sensors are cleared and the OverOut switches to logical 0 (FALSE).

Override can be set to **Spring Return Key** or **Pushbutton**.

Override with spring return key.

This function must be activated maintaining the Override command active (OVERRIDE=1) during all subsequent operations. However, a new Override can be activated, de-activating and re-activating the command.

When the light curtain and sensors are cleared (gap free) or on expiry of the timeout, Override ends without the need for further commands.

Override with pushbutton

This function is enabled activating the Override command (OVERRIDE=1).

Override ends when the light curtain and sensors are cleared (gap free) or on expiry of the timeout. The function can be restarted only if the Override command is reactivated (OVERRIDE=1).

**Parameters**

**With sensors occupied:** Must be selected with "T" sequential, simultaneous muting; with "L" muting, must not be selected.

- ➔ Otherwise, a Warning is displayed in the compilation phase and in the report.
- ➔ The user must adopt additional safety measures during the Override phase.

*Conditions to be checked for activation of Override*

"With occupied sensors" selected	Occupied sensor	Light curtain occupied	Input	Override request	Override output
X	X	-	0	1	1
-	-	X	0	1	1
	X	-	0	1	1
	X	X	0	1	1

**Timeout (sec):** Used to set the time, between 10 sec and infinity, by which the Override function must end.

**Override mode:** Used to configure the type of Override (pulsed or maintained action).

**With OverOut:** Used to activate an Override active Signaling output (active when high).

**With Request:** Used to activate a Signaling output (active when high) indicating that the Override function can be activated.

**Manual Reset:**

- Should the INPUT be active (TRUE), the reset enables the output of the function block.
- Should the INPUT be not active (FALSE), the output of the function block follows the OVERRIDE request.

There are two types of reset: Manual and Monitored. When Manual is selected the system only verifies the signal's transition from 0 to 1. If Monitored is selected the double transition from 0 to 1 and then back to 0 is verified.

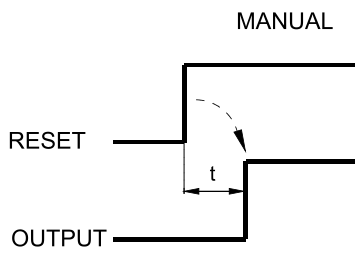

$t = 250 \text{ ms}$

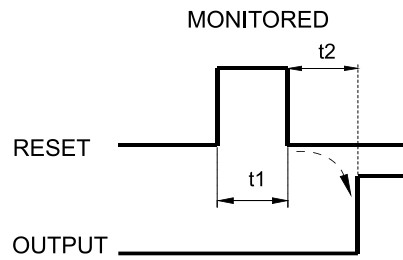

$5s > t1 > 250 \text{ ms}$   
 $t2 = 250 \text{ ms}$

ANALOG OPERATORS (MOSAIC M1S/MOSAIC M1S COM)

**ANALOG COMPARATOR**

This operator works as a comparator of an analog signal connected.

The threshold value to be entered will be in engineering units (eg Kg, °C) and must respect the limits defined by the functional block connected to the **“Analog”** input.

When the input value is lower than the threshold, the output Q will be at level 0 (FALSE).

When the input value is equal or greater than to the threshold, the output Q will be at level 1 (TRUE).

The **“Analog”** input can be connected to:

- *the analogue output of an “ANALOG COMPARISON” input block*
- *the analogue output of a “MATH” block.*

The hysteresis used in the comparison will be the one programmed in the functional block connected upstream.

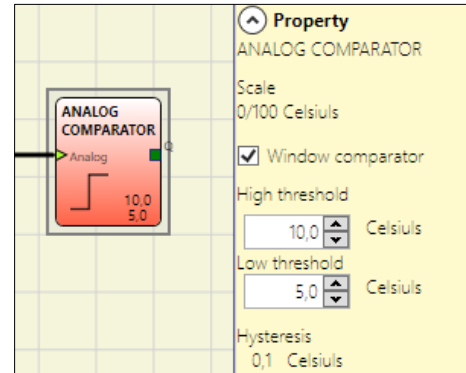

**Window comparator:**

When the window comparator is enabled the user can choose a high threshold value and a low threshold value.

The output state of the window comparator depends on the value of the measurement and on its current state. There are two possible states:

- ➔ **OUT OF WINDOW:** the output of the comparator is a logic 0 (FALSE)
- ➔ **IN WINDOW:** the output of the comparator is a logic 1 (TRUE)

If the measurement values are over “High threshold” value or under “Low threshold - Hysteresis” value then the state of the window comparator is “OUT OF WINDOW”.

If the state of the window comparator is “IN WINDOW” and measurement values are under “High threshold” value or over “Low threshold - Hysteresis” value, then the state of the window comparator still remains “IN WINDOW”.

If the state of the window comparator is “OUT OF WINDOW” and measurement values are over “High threshold - Hysteresis” value or under “Low threshold” value then the state of the window comparator still remains “OUT OF WINDOW”.

The window comparator turns its state into “IN WINDOW” only if the measurement values are under “High threshold - Hysteresis” value or over “Low threshold” value.

In the following picture is given an example of the behavior of the window comparator.

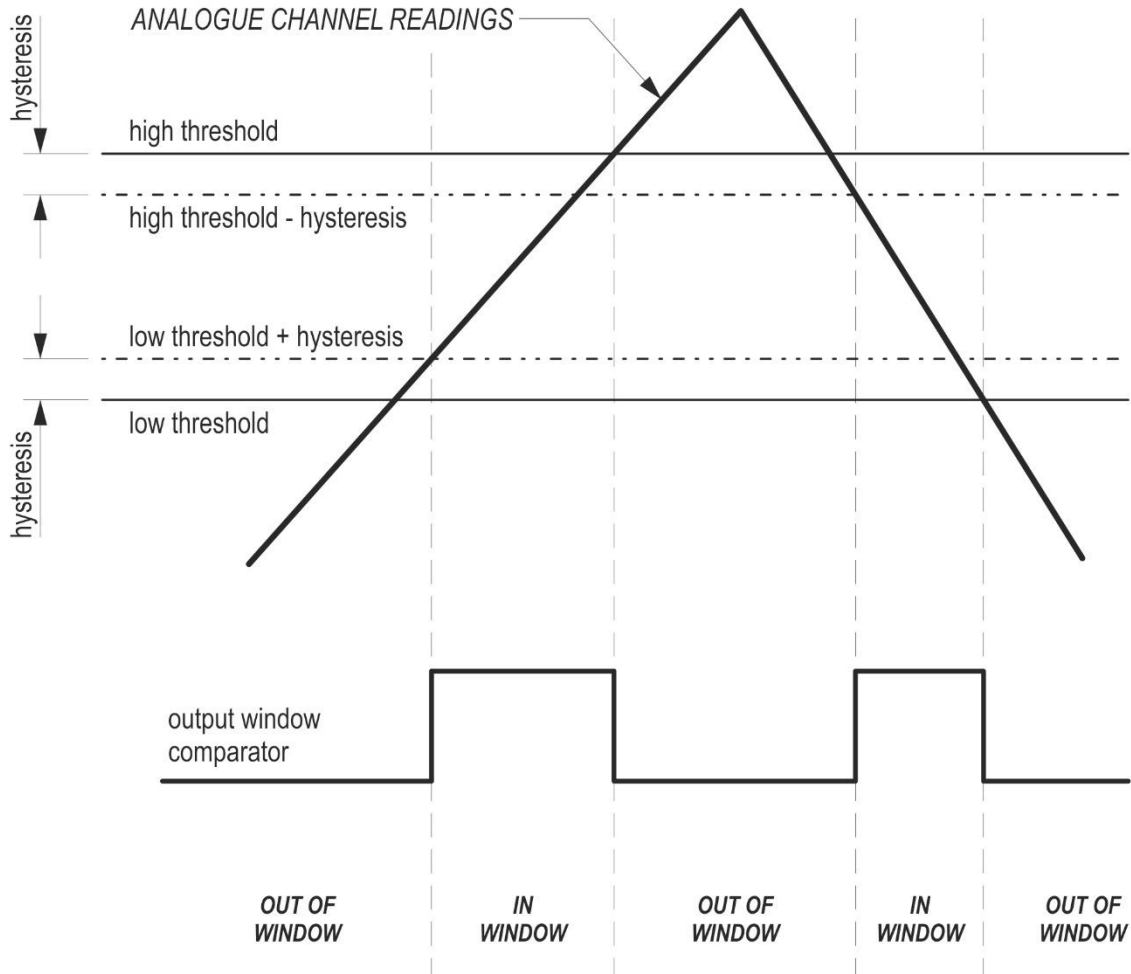

*Example of window comparator behavior*

When the window comparator is not enabled, the output state of the threshold comparator depends on the value of the measurement and on its current state. There are two possible states:

- ➔ OVER THRESHOLD: the output of the comparator is a logic 1 (TRUE)
- ➔ UNDER THRESHOLD: the output of the comparator is a logic 0 (FALSE)

If the measurement values are over “Threshold” value then the state of the threshold comparator is “OVER THRESHOLD” until the measurements stay over “Threshold-Hysteresis” value.

If the measurement values are under “Threshold-Hysteresis” value then the state of the threshold comparator is “UNDER THRESHOLD” until the measurements stay under “Threshold” value.



In the following picture is given an example of the behavior of the threshold comparator.

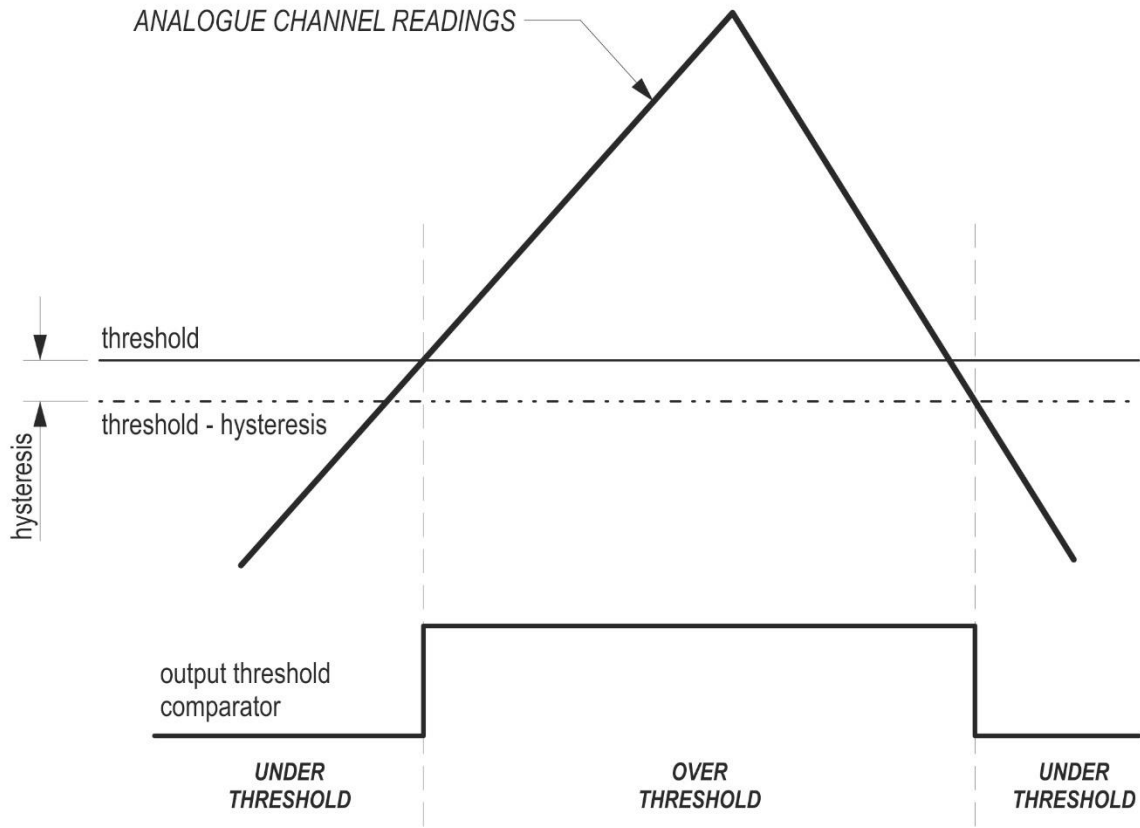

*Example of threshold comparator behavior*

**Math (max number = 16)**

The Math operator performs the sum (or the difference) between analog signals coming from an ANALOG INPUT blocks.

The signals must have the same physical unit and must be generated by sensors of the same type (4/20mA, 0/20mA or 0/10V) but they can have different scales.

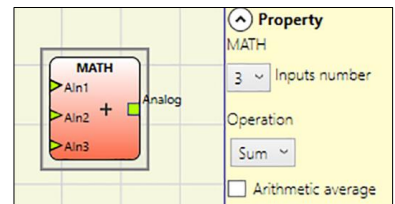

**Parameters**

**Input number:**

Sum: **it's possible to sum** from 2 to 8 signals.

Difference: **it's possible to perform difference** of 2 signals.

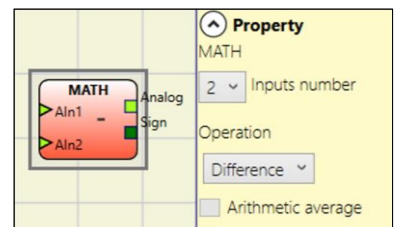

**Operation:**

Sum: The result will be the sum of all the inputs. Difference: The result of the operation will be the absolute value of the difference  $|(\mathbf{Ain1} - \mathbf{Ain2})|$  with relative sign (output **Sign**). The Sign output will be at 0 (FALSE) if the sign of the difference is positive, while it will be at 1 (TRUE) if the sign is negative.

Arithmetic average:

Setting Arithmetic Average box with Operation as Sum, the output value of this operator will be the arithmetic average of the various inputs.

**EQUALITY CHECK (max number = 16)**

This operator checks if two analog inputs are equal within a selectable value. The signals must have the same physical unit and must be generated by sensors of the same type (4/20mA, 0/20mA or 0/10V) but they can have different scales. The output Q will be 1 (TRUE) when the condition of equality is verified. If the two signals differs of an amount greater than the allowed error then the output "Q" will be 0 (FALSE).

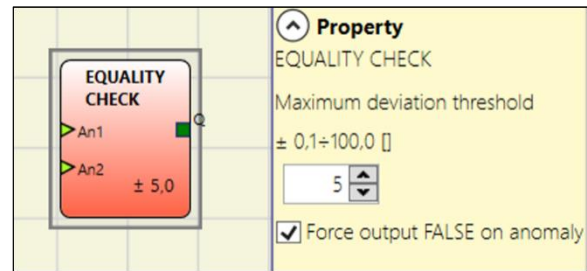

**Parameters**

Allowed error:  
Corresponds to the maximum tolerance between the difference of the values AN1 and AN2.

Force output FALSE on anomaly:  
If checked and in presence of the connected analog input's anomaly (the analogue value assumes a full scale value), the output of the block will remain at 0 (FALSE) as in the presence of different signals.

**MISCELLANEOUS FUNCTION BLOCKS**

**SERIAL OUTPUT (max number = 4 with MOSAIC M1, 8 with MOSAIC M1S, MOSAIC M1S COM)**

The Serial Output operator outputs the status of up to 8 inputs, serialising the information.

Operating principles.  
This operator outputs the status of all the connected inputs in two different ways:

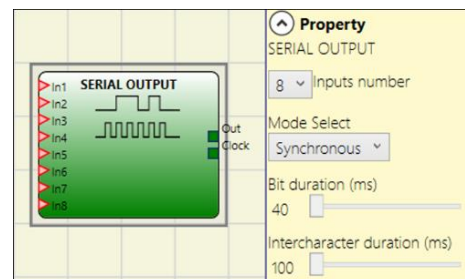

- Asynchronous serialisation:
- 1) The status of the line in the idle condition is 1 (TRUE);
  - 2) The start data transmission signal is 1 bit = 0 (FALSE);
  - 3) Transmission of *n* bits with the status of the connected inputs encoded using the **Manchester** method:
    - Status 0: rising edge of the signal at the centre of the bit
    - Status 1: falling edge of the signal at the centre of the bit
  - 4) Intercharacter interval is 1 (TRUE) to allow synchronisation of an external device.

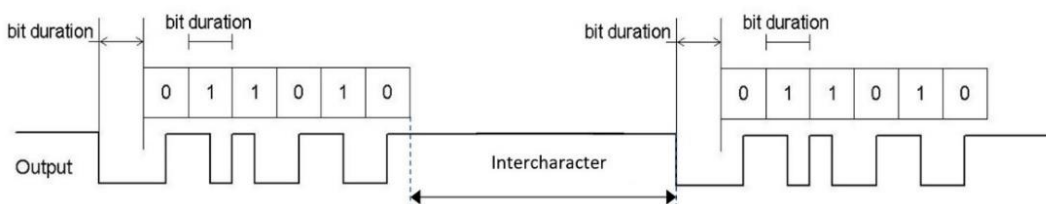

Therefore, with the Asynchronous method the **Clock** output is not present.

Synchronous serialisation:

- 1) The output and the clock in the idle condition are 0 (FALSE);
- 2) Transmission of *n* bits with the input status using OUTPUT as data, CLOCK as the timing base;
- 3) Intercharacter interval is 0 (FALSE) to allow synchronisation of an external device.

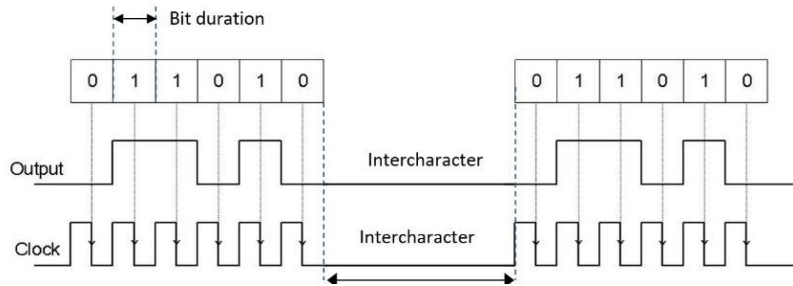

**Parameters**

Inputs number: Defines the number of inputs of the function block, which may be 2÷8 (*asynchronous*) or 3÷8 (*synchronous*).

Mode select: The user can choose two ways of transmission: Asynchronous and Synchronous. **Please refer to “Operating principles” at the top of this page.**

Bit length (ms): Enter the value corresponding to the length of each single bit (input *n*) in the pulse train that makes up the transmission.

- 40 ms...200 ms (Step 10 ms)
- 250 ms...0.95 s (Step 50 ms)

Intercharacter interval (ms): Enter the time that must pass between the transmission of one pulse train and the next.

- 100 ms...2.5 s (Step 100 ms)
- 3 s...6 s (Step 500 ms)

**NETWORK (max number = 1)**

The Network operator is used to distribute Stop and Reset commands via a simple local network. Use Network\_in and Network\_out to exchange **START**, **STOP** and **RUN** signals between the different nodes.

Operating principles.

This operator allows stop and reset commands to be simply distributed in a local Mosaic network.

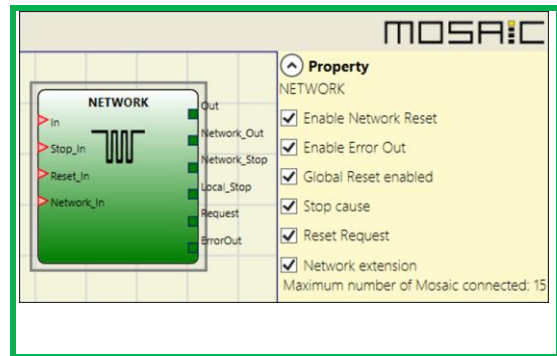

The Network operator requires the following:

- 1) the Network\_In input (single or double) must be connected to the Network\_Out output of the preceding unit in the local network.
- 2) the Network\_Out (could be a STATUS or OSSD output), must be connected to the Network\_in input of the next unit in the local network.
- 3) the Stop\_In and Reset\_In inputs must be connected to input devices that act as Stop (e.g. E-STOP) and Reset (e.g. SWITCH), respectively.
- 4) the In input can be connected freely in the diagram (e.g. input function blocks or results of logical combinations).
- 5) Output can be connected freely in the diagram. Output is 1 (TRUE) when the IN input is 1 (TRUE) and the function block has been restarted.

**Parameters**

Enable Network Reset: when selected allows the distribution network to reset the function block. If not enabled, the function block can only be reset via the local Reset\_In input.

Enable error out: if selected, it enables the Error\_Out output that can be used to signal, with a logic 1 (TRUE), the presence of a failure.

Global Reset Enable: if selected, the operator can restart the entire system with the reset button from any node in the network. If deselected the operator can restart all the nodes that have been not caused the stop from anywhere in the network, except the node that has caused the stop (this node has to be restarted with its own reset).

Stop cause: (only MOSAIC M1S/MOSAIC M1S COM) if selected, it enables the Network\_stop and Local\_stop outputs and indicates the cause of the STOP status. These outputs are normally at 0 with the system in RUN and the Output at 1 (TRUE). If a network stop is requested, the Network\_stop output increases to 1 (TRUE). If the Output output goes to 0 due to the In input or the Stop\_in input, the Local\_stop output goes to 1 (TRUE). The outputs will remain in this status until the next main reset.

 The RESET command must be installed outside the zone of operation in a position where the zone of operation and the entire work area concerned are clearly visible.

- ➔ The maximum number of MASTER modules that can be connected in network configuration is equal to 10 (or 15 if Network extension is checked).
- ➔ Each Master module can have a maximum of 9 expansion modules connected.

Reset Request: enables an additional output "*Reset Request*" that becomes active if reset is requested.

Network extension: increases the number of connected MASTERS from 10 to 15.

Condition 1:

*With reference to the Figure 112 and Figure 113, at power-on:*

1. The Net\_out of the various nodes are in the 0 (FALSE) condition;
2. The STOP signal is sent via the Net\_out line;
3. When the RESET command is pressed on one of the nodes all the nodes that are present are started when the START signal is sent;
4. As the end result, the Net\_out of all the connected nodes is in condition 1 (TRUE) if the various Net\_in inputs are in condition 1 (TRUE);
5. The RUN signal is sent via the network of the 4 nodes present.

Condition 2:

*With reference to the Figure 112 and Figure 113, when the emergency stop is pressed in one of the four nodes:*

1. The Net\_out moves to condition 0 (FALSE);
2. The STOP signal is sent via the Net\_out line;
3. The next node receives the stop code and deactivates the output;
4. The stop command generates the stop code for all Net\_in and Net\_out lines;
5. As the end result, the Net\_out of all the connected nodes is in condition 0 (FALSE).
6. When the emergency stop is restored to the normal position, all the nodes can be restarted by sending the START signal with a single reset. The latter condition does not occur when ENABLE RESET NETWORK is not enabled. In that case, the local reset method must be used. The system will employ about 4s to restore all the outputs of the blocks that make up the network.

➔ Perform a local reset of the module which caused the network shutdown, to restore its safety output.

#### Response Time

*The max response time of the network starting from emergency stop is given by the formula:*

$$\text{(Master MOSAIC M1) } t_r = 11.3 \text{ ms} + [175.3 \text{ ms} \times (\text{number of controllers} - 1)]$$

$$\text{(Master MOSAIC M1S/MOSAIC M1S COM) } t_r = 12.7 \text{ ms} + [232.7 \text{ ms} \times (\text{number of controllers} - 1)]$$

Emergency Stop Pressing	MASTER n°1	MASTER n°2	MASTER n°3	MASTER n°4
	$t_{rMASTER1}$	$t_{rMASTER2}$	$t_{rMASTER3}$	$t_{rMASTER4}$
Master MOSAIC M1	11.3 ms	186.6 ms	362 ms	537.2 ms
Master MOSAIC M1S/MOSAIC M1S COM	12.7 ms	245,4 ms	478.1 ms	710.8 ms

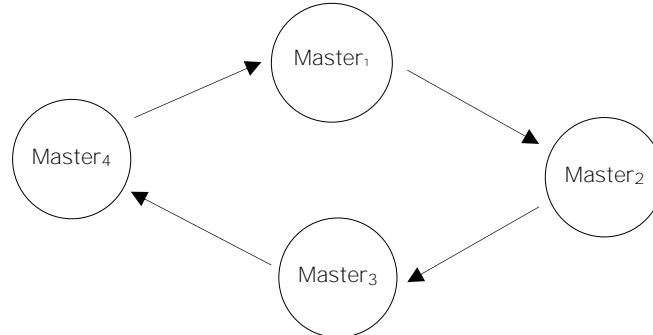

Condition 3:

With reference to the Figure 110 and Figure 111, when the IN input of the NETWORK function block of one of the 4 nodes moves to condition 0 (FALSE):

1. The local OUTPUT moves to condition 0 (FALSE);
2. The RUN signal continues to be sent via the Network\_out lines;
3. The states of the remaining nodes remain unchanged;
4. In that case, local reset must be used. The Reset-in LED flashes to indicate this condition. This condition is signaled by the corresponding LED flashing Reset\_In entrance.  
The affected node will be restarted with its own reset (if 'Reset Global Reset' is not selected).

The Network\_in input and the Network\_out output can only be mapped to the I/O pins of the MASTER.

Master MOSAIC M1 signals with Network operative

		NETWORK FUNCTIONAL BLOCK SIGNALS				
		Network in		Network out (OSSD)	Network out (STATUS)	Reset in
LED		FAIL EXT	IN (1)	OSSD (2)	STATUS	IN (3)
STATUS	STOP	OFF	OFF	RED	OFF	OFF
	CLEAR	OFF	BLINKING	RED/GREEN (BLINKING)	BLINKING	BLINKING
	RUN	OFF	ON	GREEN	ON	ON
	FAIL	ON	BLINKING	-	-	-

(1) Corresponding to the input where is wired Network IN  
 (2) Corresponding to the input where is wired Network OUT  
 (3) Corresponding to the input where is wired Reset IN

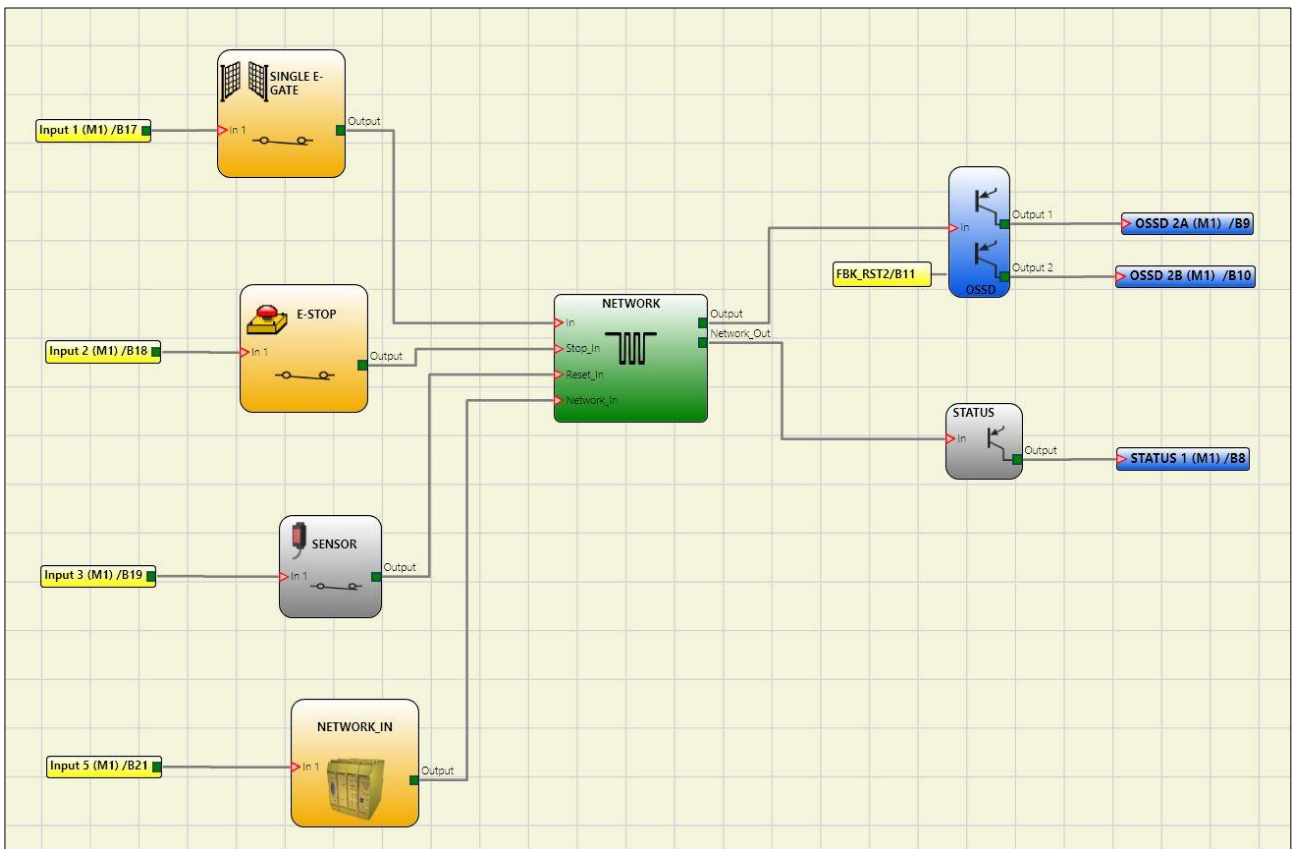

Figure 110 - NETWORK function block scheme example (Category 2)

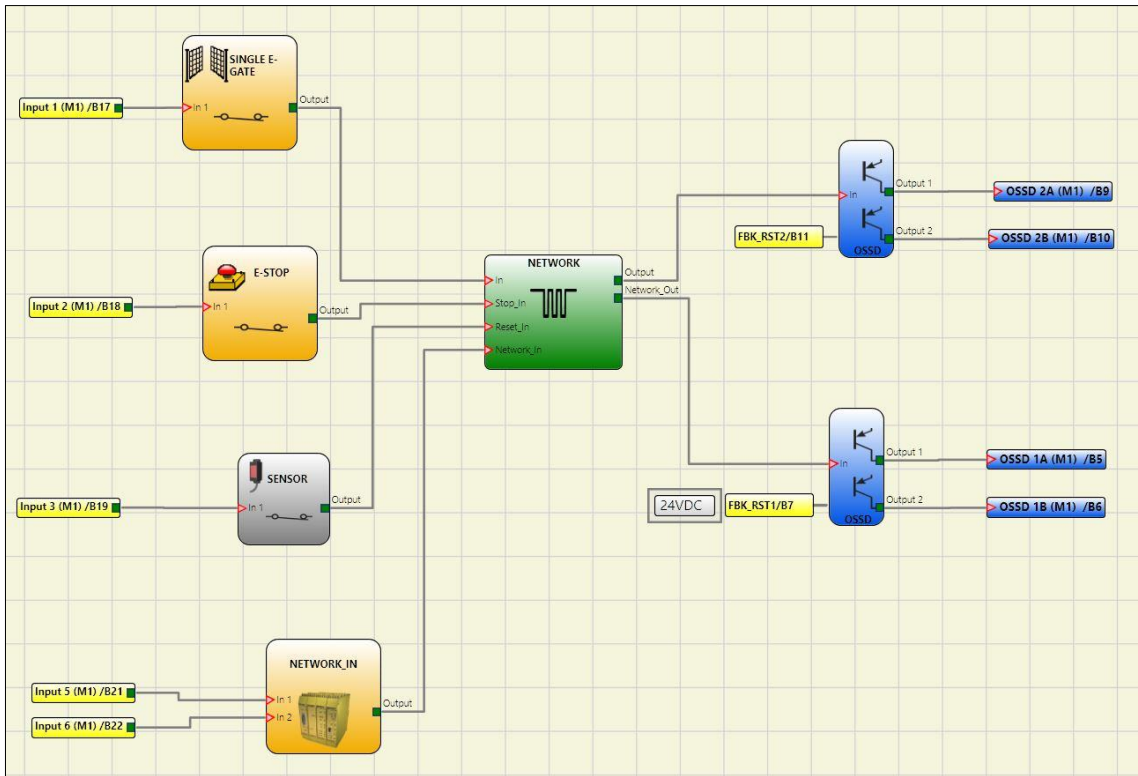
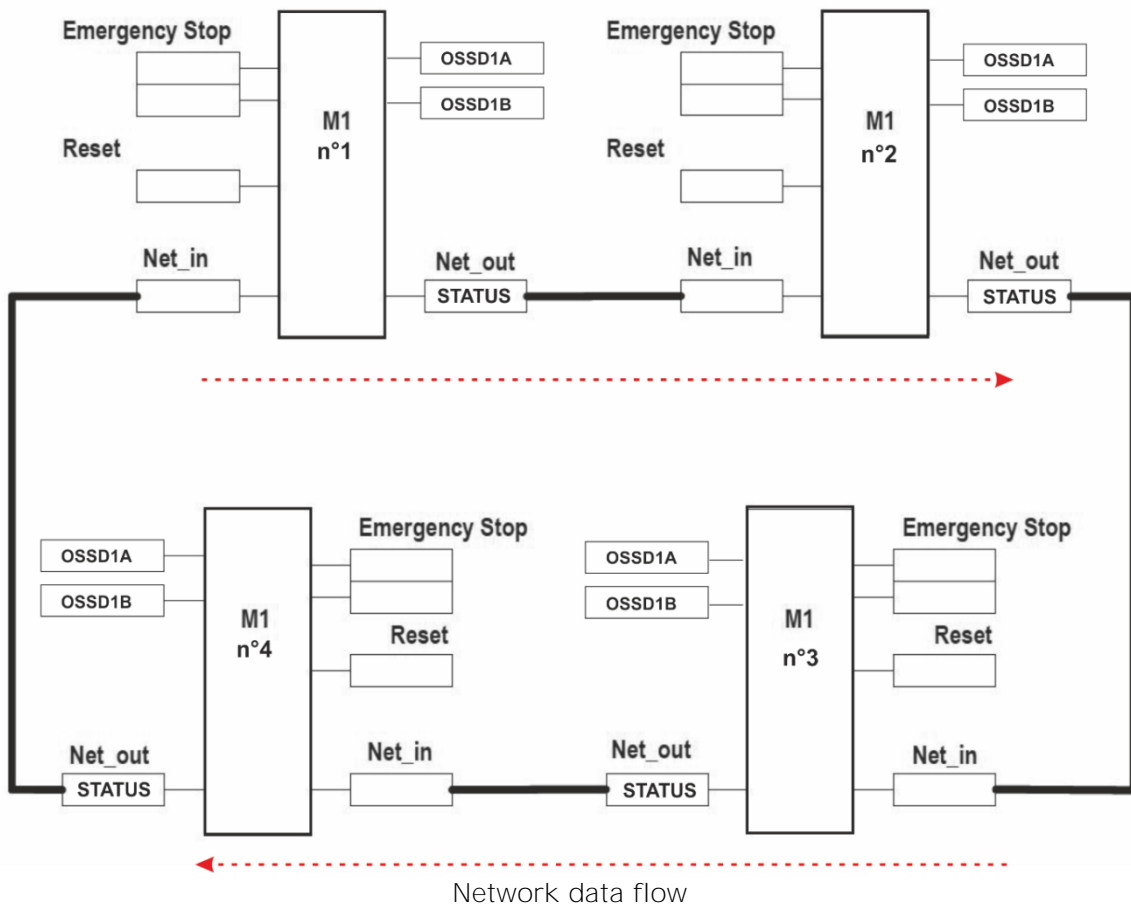

Figure 111 - NETWORK function block scheme example (Category 4)

Example of application in Category 2 according to ISO 13849-1:



Network data flow

Figure 112

Network parameters for the PL calculation

Architecture:	Cat.2
Diagnostic coverage:	DC = 90%
Reliability of Module MOSAIC M1:	MTTF <sub>d</sub> = 437 (years)

Logical block diagram of a safety function using the network

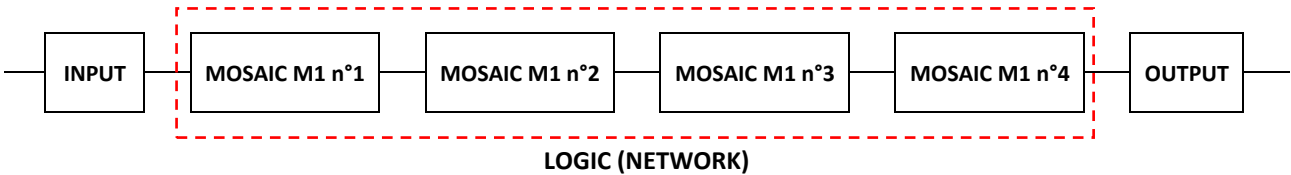

Example of application in Category 4 according to ISO 13849-1:

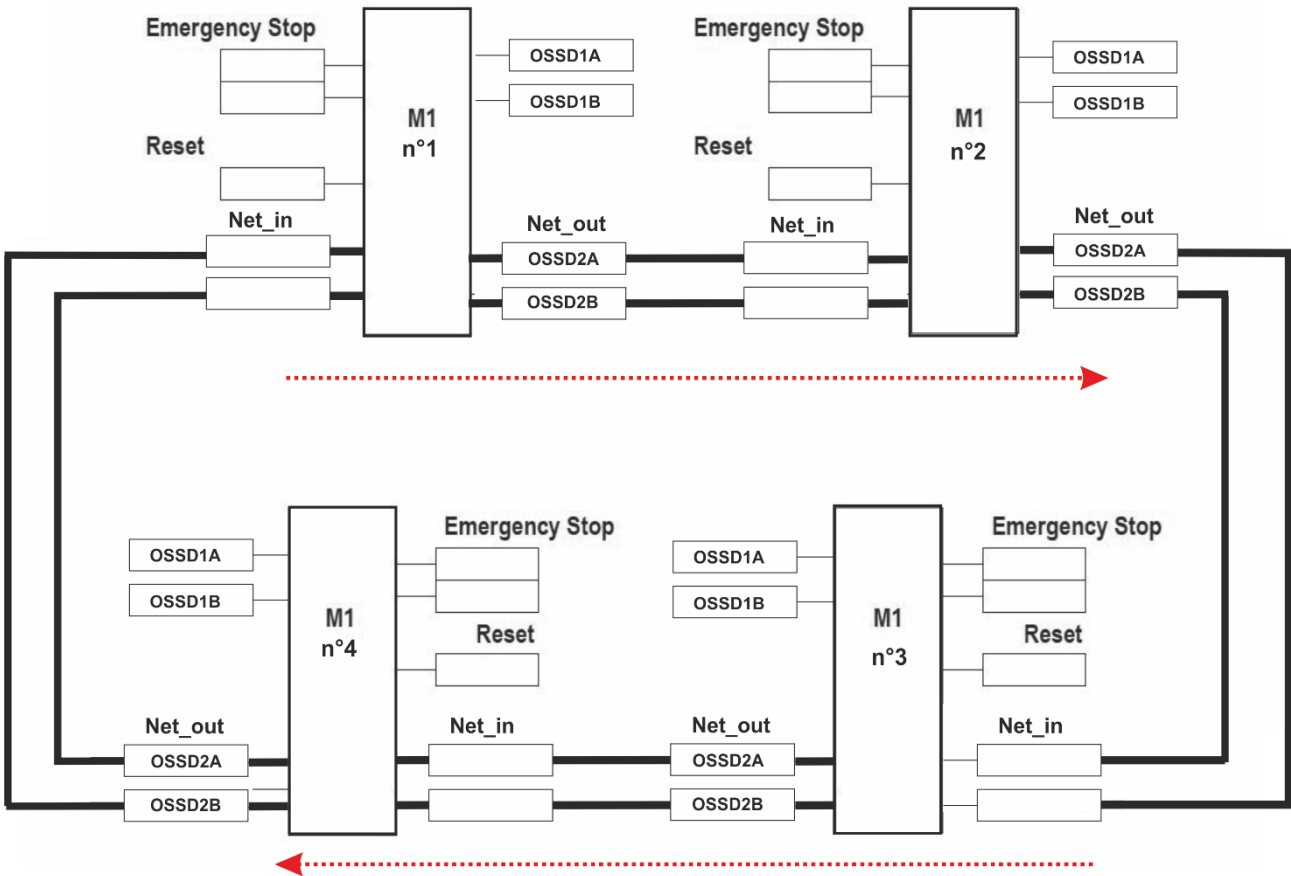

Network data flow

Figure 113

Network parameters for the PL calculation

Architecture:	Cat.4
Diagnostic coverage:	DC = 99%
PFH Module MOSAIC M1:	PFH <sub>d</sub> = 6,86E-09 (hour <sup>-1</sup> )



Logical block diagram of a safety function using the network

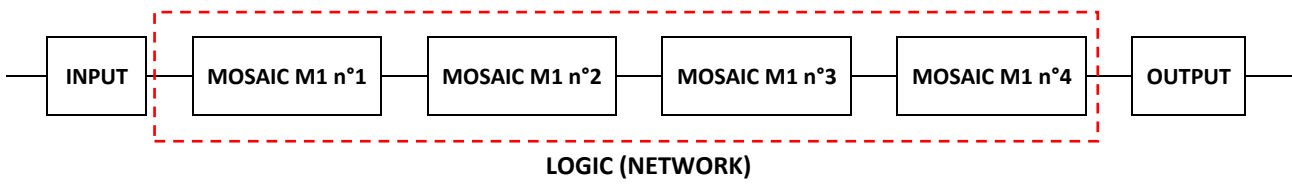

RESET MOSAIC M1

This operator generates a system Reset when there is a double OFF-ON-OFF transition on the corresponding input which lasts less than 5 s.

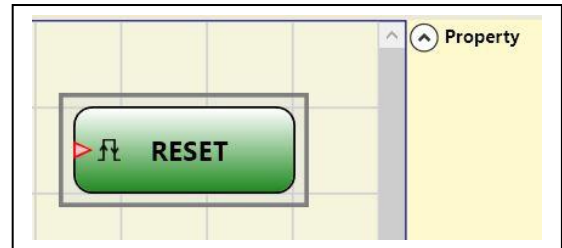
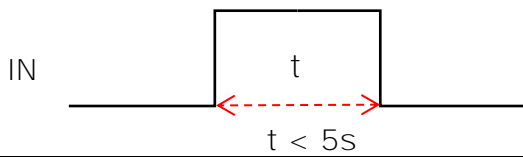

- ➔ If > 5s, RESET is not generated.
- ➔ It can be used to reset faults without disconnecting system power.

OSSD EDM (MOSAIC M1S / MOSAIC M1S COM, max number = 32)

The OSSD EDM (External Device Monitoring) operator allows to control an EDM feedback related to a safety output using a generic Mosaic input.

The Output can only be connected to one safety output functional block (OSSD, single OSSD, Relay). This output functional block must have the K external time monitor deactivated.

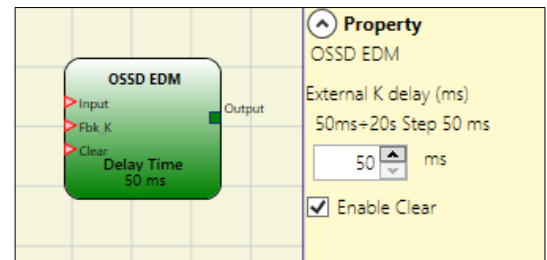

- OSSD output connected downstream is at high level (TRUE) -> the **Fbk\_K** signal must be at low level (FALSE) (within the set delay) and vice versa.
- If the delay is not respected, the **Output** of the OSSD EDM block goes to low level (FALSE) and the anomaly is signaled by the flashing of the CLEAR led corresponding to the OSSD in error.

If **Enable Error Out** of the connected output is selected, this output is set to high level (TRUE) when an external FBK error is detected (example: exceeded the external time K).

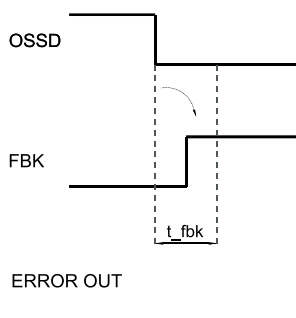

Example of OSSD with correct Fbk signal:  
In this case ERROR OUT=FALSE

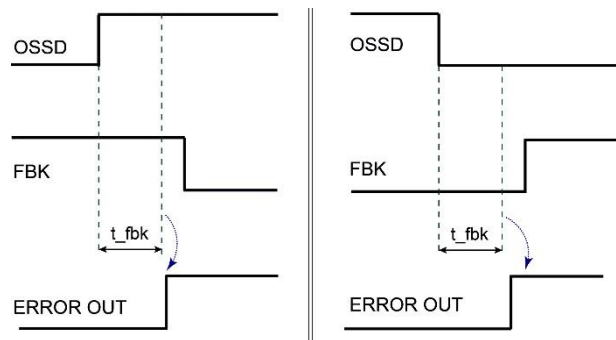

Example of OSSD with incorrect Fbk signal  
(External K delay exceeded):  
In this case ERROR OUT=TRUE

Parameters

**External K delay:** allows the operator to set the time window within which the external feedback signal (Fbk\_K) is to be monitored (according to output conditions).

**Enable Clear:** if checked enables input Clear.

With this input at 1 it is possible to clear the error when the fault has been repaired. Using this input it is no longer necessary to reset MOSAIC M1S/MOSAIC M1S COM or turn off the system.

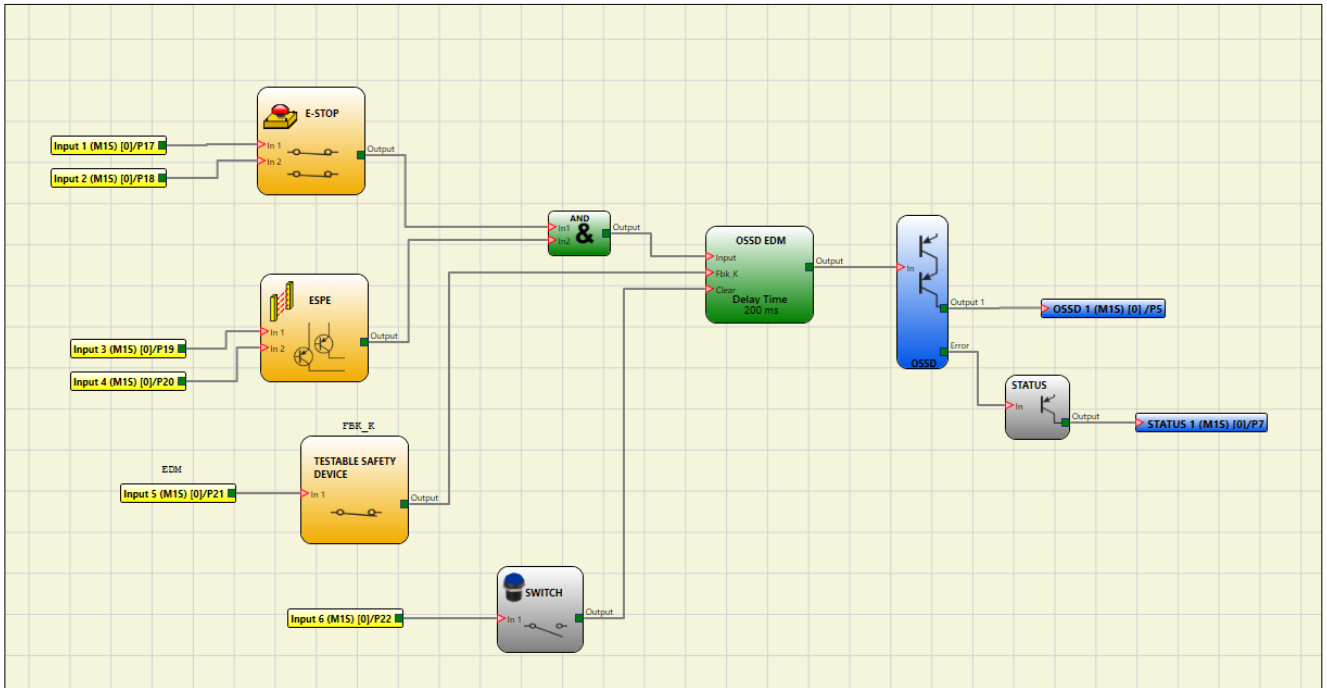
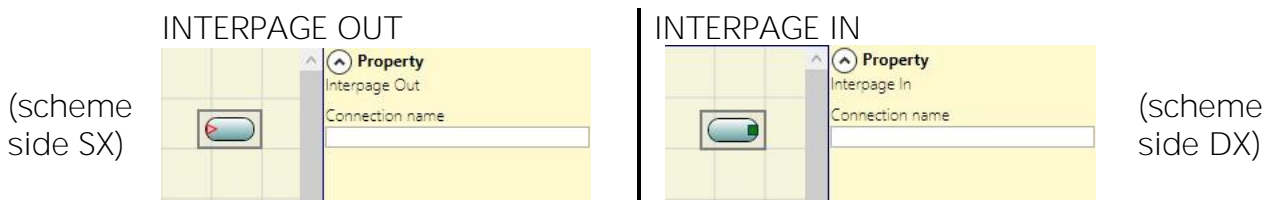

Figure 114 - OSSD EDM operator scheme example

INTERPAGE IN/OUT

If the scheme is very complicated and requires a connection between two elements very far, use the "Interpage" component.



The element "**Interpage out**" must have a name which, invoked by the corresponding "**Interpage in**", allows the desired link.

**INTFBK\_IN / INTFBK\_OUT (MOSAIC M1S/MOSAIC M1S COM only, max number = 8)**

This operator can be used to create logical loops or to connect the output of a function block to the input of another function block. IntFbk consist of *IntFbk\_In* and *IntFbk\_Out*; after one MOSAIC M1S/MOSAIC M1S COM logical cycle delay, every *IntFbk\_In* assumes the same logical value of the corresponding *IntFbk\_Out*.

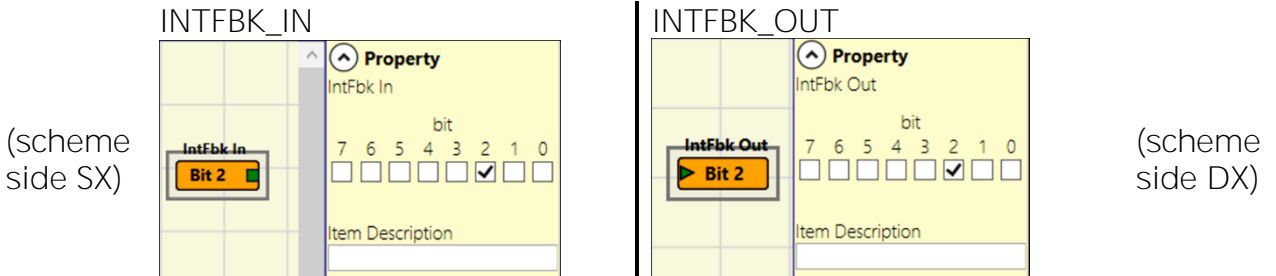

The element "*IntFbk\_Out*" must have a number which, invoked by the corresponding "*IntFbk\_In*", allows the desired link.

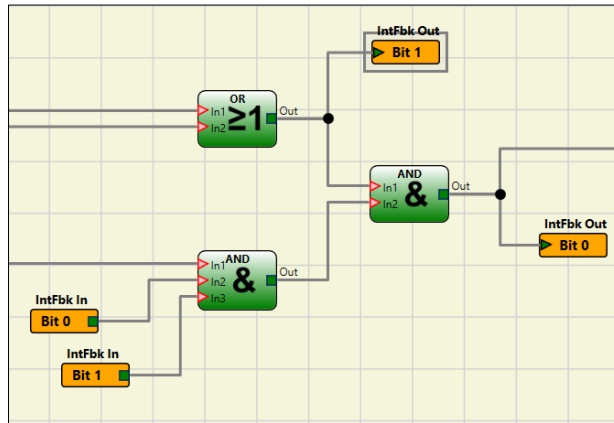
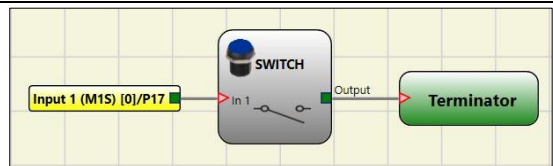

Figure 115 - INTFBK\_IN / INTFBK\_OUT operator scheme example

**⚠** If not carefully designed feedback loops could trigger dangerous system oscillations and as a consequence makes the system instable. An instable system may have severe consequence to the user like severe injuries or death.

**TERMINATOR**

This operator can be used as a terminator for inputs not used in the scheme. The input connected to the TERMINATOR operator appears in the input map and its status is transferred to the BUS.



Special Applications

Output delay with manual

If the operator needs to have two OSSD output with one of them delayed (in MANUAL mode) use the following scheme:

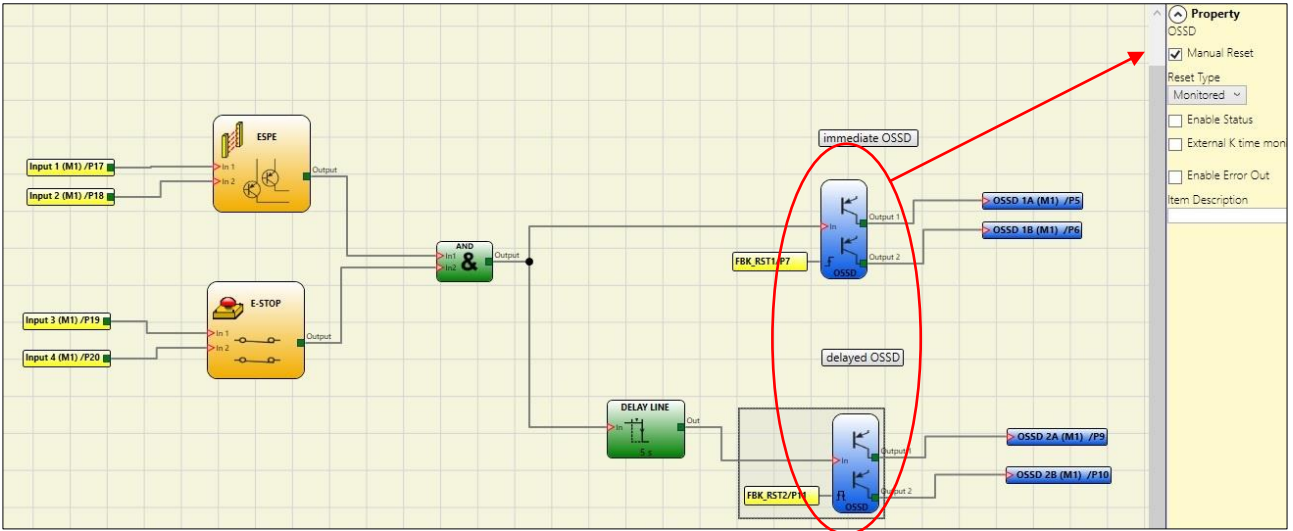

Figure 116 - Two outputs with one delayed (in MANUAL mode)

Simulator

- ✦ This simulator is only designed to assist in the design of safety functions.
- ✦ The results of the simulation do not constitute validation of the project.
- ✦ The resulting safety function must always be validated, from the point of view of both hardware and software, under actual usage conditions in accordance with the applicable regulations, such as ISO/EN 13849-2: validation or IEC/EN 62061: Chapter 8 - Validation of the safety-related electrical control system.
- ✦ Mosaic configuration safety parameters are provided in the MSD software report.

The top toolbar features two new green icons (with firmware MOSAIC M1 version 3.0 or higher):

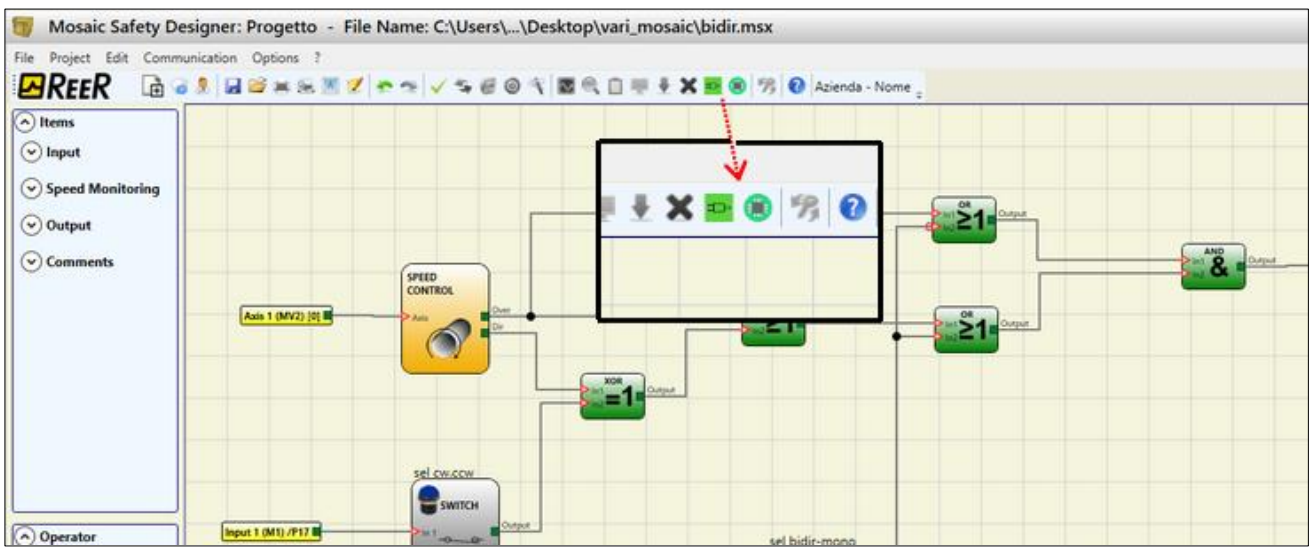

Figure 117 – Simulator icons

These icons refer to the new Simulator function.

- The first icon indicates "Schematic Simulation". It enables the schematic simulator (both static and dynamic) in which you can activate the input to verify the diagram that is loaded.
- The second icon indicates "Graphic Simulation". It enables the simulator guided by the stimuli file which also allows the desired traces to be displayed in a specific graph.

➔ THE SIMULATION ICONS ARE ONLY AVAILABLE WITH NODE MOSAIC M1 DISCONNECTED.

Schematic Simulation

Click on the  icon to start the schematic simulation.

Schematic simulation can be used to check/guide the output signals of the various function blocks in real-time, even during the actual simulation. You may choose the block outputs you wish to control and check the response of the various elements of the schematic model according to the colour of the different lines.

As with the monitor function, the colour of the line (or of the actual key) indicates the signal status: green means the signal is set to LL1, red means the signal is set to LLO.

With "Schematic Simulation", some new keys appear in the toolbar. These can be used to control the simulation: the "Play" and "Stop" keys to start and stop the simulation, the "PlayStep" key for step-by-step operation and the "Reset" key. When the simulation is reset, the Time value is reset to 0 ms.

When you press "Play" to start the simulation, the amount of time that has elapsed is displayed next to the word "Time". This time is measured in "Step" units of time multiplied by the user-defined "KT" factor.

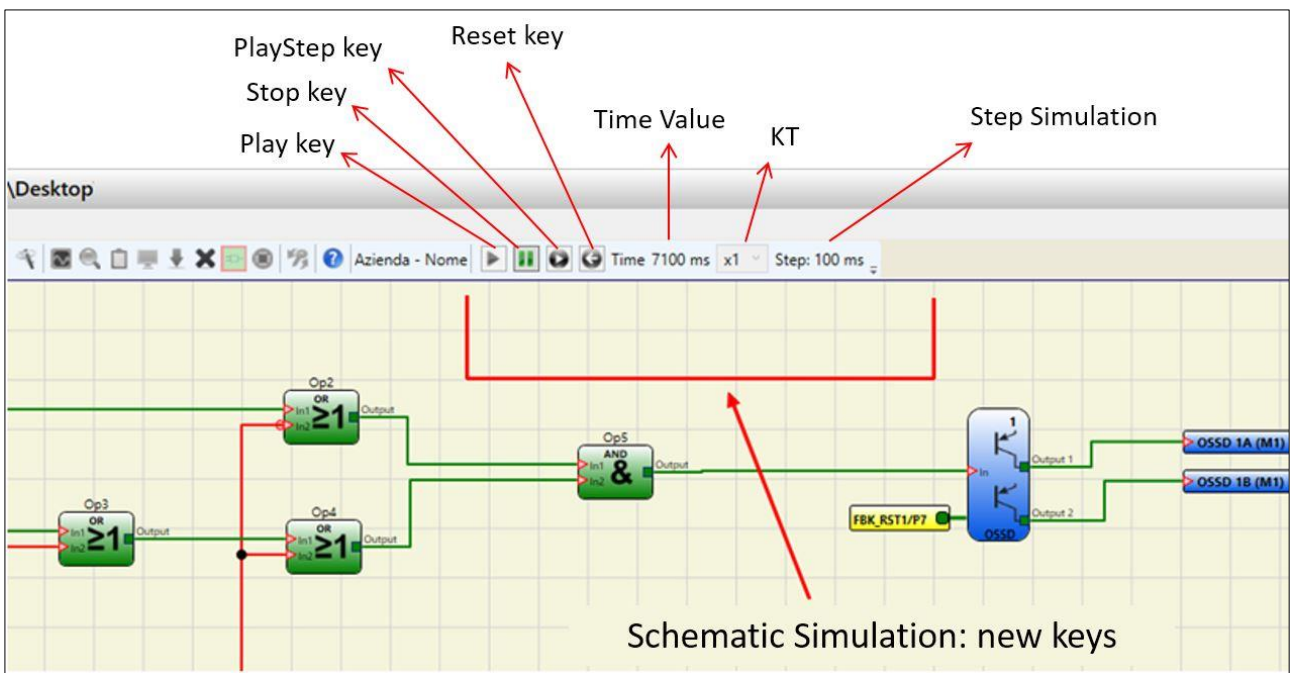

Figure 118 – Schematic Simulation

Click on the bottom right key of each input block to activate the respective output status (even when the simulator is not running, i.e. when the time is not elapsing: in this case the simulation is "static"). If the key turns red when you click on it, the output will be set to level LLO. If it turns green, the output will be set to level LL1.

In some function blocks, such as "speed control" or "lock\_feedback", for example, the key is grey. This indicates that the value must be entered manually in a specific pop-up window. The type of value to be entered differs according to the type of function block (e.g., in a "speed control" block you will need to enter the frequency).

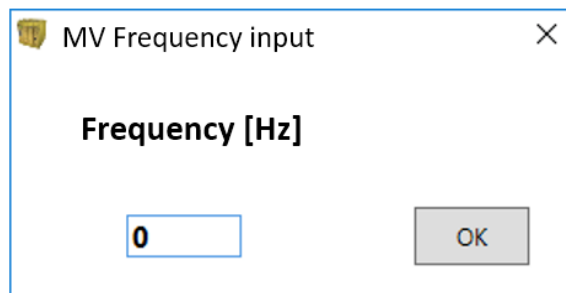
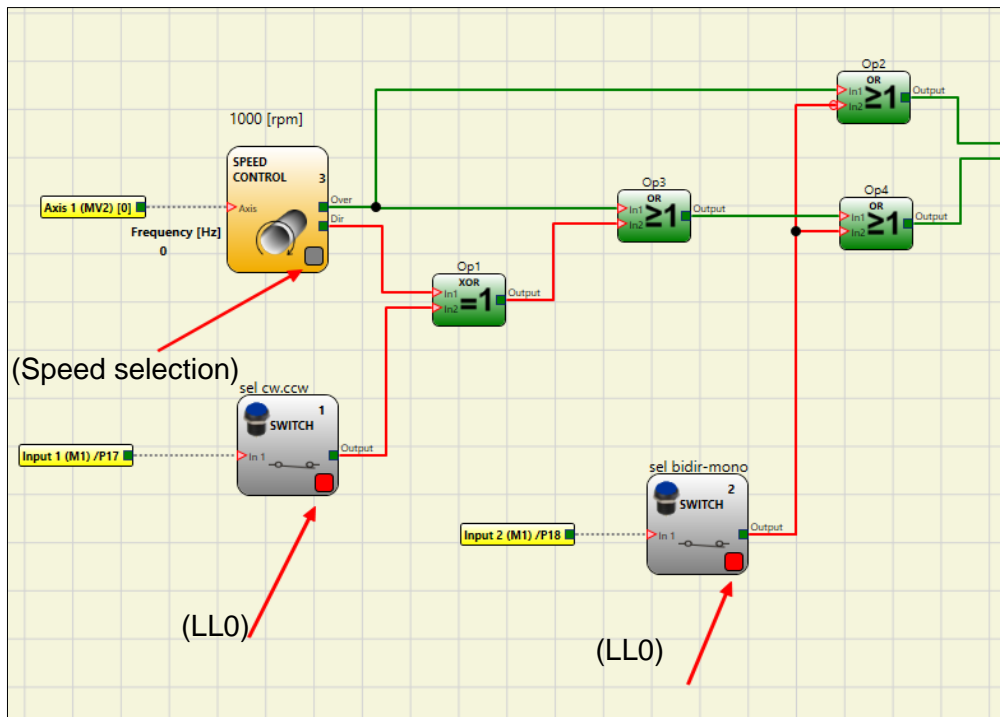

Figure 119 - MV frequency input

➔ The keys for enabling block outputs are shown at the top, an example of a pop-up window for entering, in this case, the frequency in a "speed control" block is shown at the bottom

### How to use graphic simulation

Click on the icon to start the graphic simulation.

Graphic simulation can be used to display the signal pattern over time in a graph. First you must define the stimuli in a specific text file: this means defining the trend over time in the waveforms used as inputs (stimuli). Based on the stimuli file created, the simulator injects these into the diagram and displays the traces required in order to perform the simulation.

When the simulation is complete, a graph like the one shown below is automatically displayed. From the graph you can print the traces displayed ("Print"), save the results in order to load them again later (Save) or display other traces ("Change visibility"). The names of the traces match the description of the function blocks.

Click the "X" key (top right) to exit the graphic simulation environment.

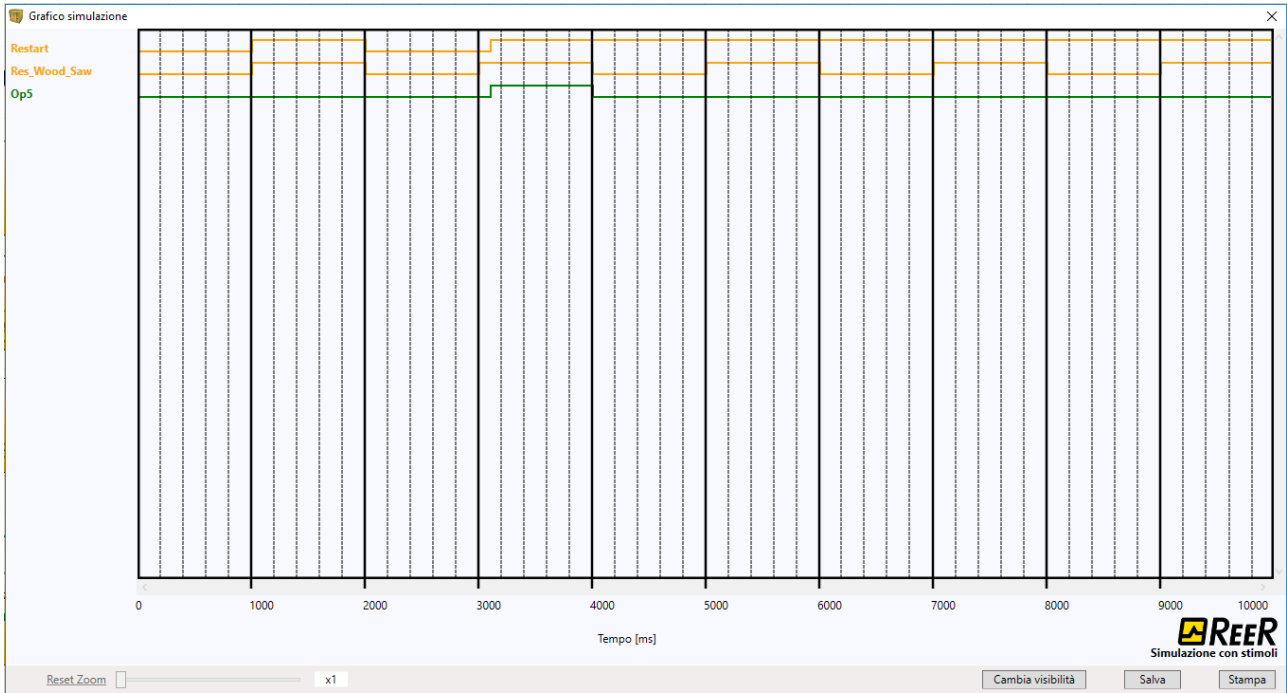

Figure 120 – Example of a result of the graphic simulation.

➔ It shows the traces and the three keys in the bottom right corner for selecting the traces, saving and printing.

The simulation can only be carried out after performing at least the following steps.

1. Create a stimuli file to suit your needs.
2. Upload the stimuli file and wait until the simulation finishes.

Click on the  icon to display the page shown below.

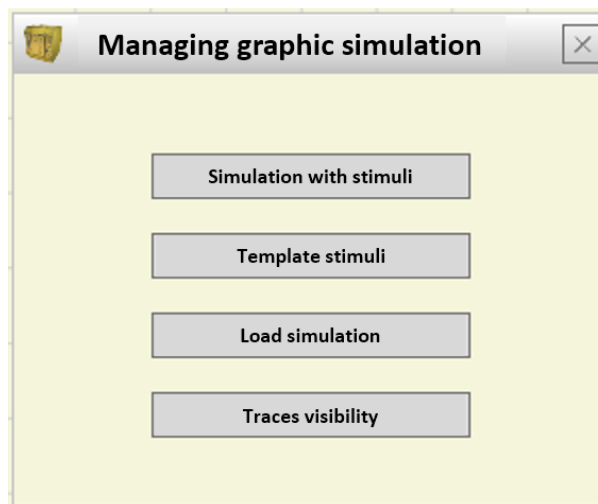

Figure 121 – Menu for selecting the graphic simulation mode

The functions of each key in the menu shown in Figure 121 will now be described:

Template Stimuli: used to save the template file with the desired name and disk location. This file will contain the names of the signals as shown in the diagram, Figure 122 Now



you may use a text editor to enter the status of the input signals at a given moment in time as well as the duration of the simulation and the time step to be used, Figure 123.

```

// Stimulus Template
//Sim 0:EndTime:Step (time unit ms)
Sim 0:10000:100

// Switch
Input1
0:0
Time1:1
Time2:0

// Switch
Input2
0:0
Time1:1
Time2:0

// Speed Control
SpeedInput3
0:8 Hz
Time1:2500 Hz
Time2:300 Hz

// OSSD
Fbk_rst1
0:0
Time1:1
Time2:0
    
```

Figure 122 – Template file immediately after saving

```

// Stimulus Template
//Sim 0:EndTime:Step (time unit ms)
Sim 0:10000:100

// Switch
Input1
0:0
800:1
2000:0
2500:1
2900:0

// Switch
Input2
0:0
1800:1
2300:0
2900:1
3900:0

// OSSD
Fbk_rst1
0:1
|
    
```

Figure 123 –Example of complete template file

Simulation with Stimuli: used to load a template file (suitably completed) and, once loaded, to immediately start the simulation.

At the end of the simulation, a graph is displayed with the resulting signals.

Load simulation: used to load a previously completed simulation, provided at least one has been saved.

Traces visibility: used to select the traces (signal waveforms) to be displayed in the graph. When you press this key, it opens a pop-up window as shown in Figure 124 from which you can add or remove traces to or from the graph.

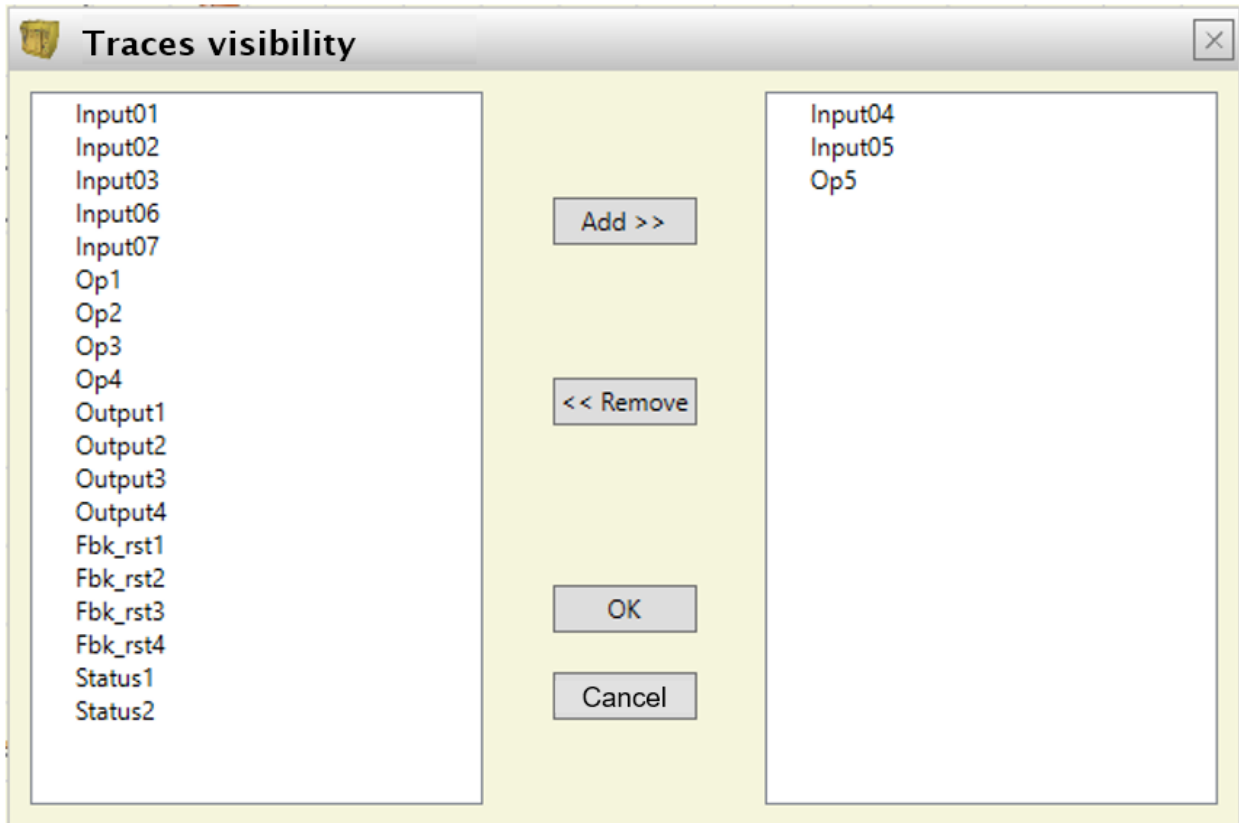

Figure 124 - Traces visibility.

➔ The traces that can be added to the graph are shown in the box on the left. The traces currently displayed and which can be removed from the graph are shown in the box on the right.

**Application example of graphic simulation**

The following example refers to the use of a press located inside a safety area. The motor of the press can only be started when two conditions are simultaneously true: the safety area gate is closed and the command to start the motor is sent. The motor will start two seconds after the start signal is sent.

**Diagram**

In the diagram the input elements are the safety area gate and the motor start command. These two signals are used as the input for an AND logic operator the result of which will be delayed by two seconds by a retarder block. The delayed signal will then energise the relay which will, in turn, allow the press motor to be started.

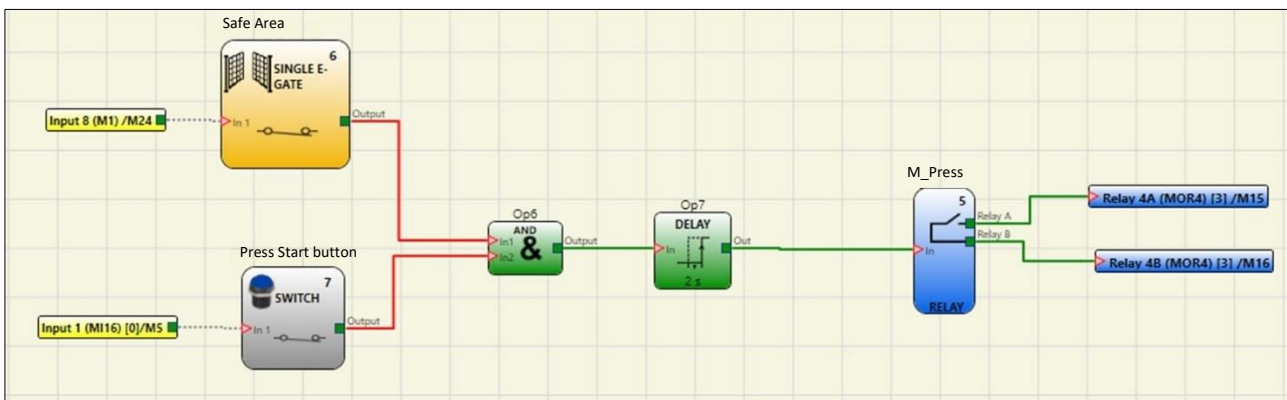

Figure 125 - Diagram referring to the application example

**Stimuli file**

The stimuli file provide the closure of the gate when 2000 ms have elapsed (signal set to LL1) and the start command sent by the operator when 3000 ms have elapsed (signal set to LL1).

```

1 // Stimulus Template
2
3 //Sim 0:EndTime:Step (time unit ms)
4 Sim 0:10000:100
5
6 // Single E-Gate - Safe Area Gate
7 Input6
8 0:0
9 2000:1
10 10000:0
11
12 // Switch Press Start button
13 Input7
14 0:0
15 3000:1
16 10000:0
    
```

comments entered by the user

Figure 126 - Stimuli file referring to the application example

## Result of the simulation

The graph shows the signals relating to the simulation, in this case:

- when 2000 ms have elapsed the “Safety area” signal rises to logic level 1, which indicates closing of the gate.
- when 3000 ms have elapsed the “Start\_Press” signal rises to logic level 1, which indicates the request to start sent by the operator
- The AND operator output signal “Op6” rises to logic level 1 when 3000 ms have elapsed, i.e., when the two “Safety area” and “Start\_Press” inputs rise to logic level 1.
- The AND operator output signal is delayed by 2000 ms by the delay operator.
- The “Op7” retarder output signal sends the command to close the relay when 5000 ms have elapsed, at which time the “M-press” relay is activated.

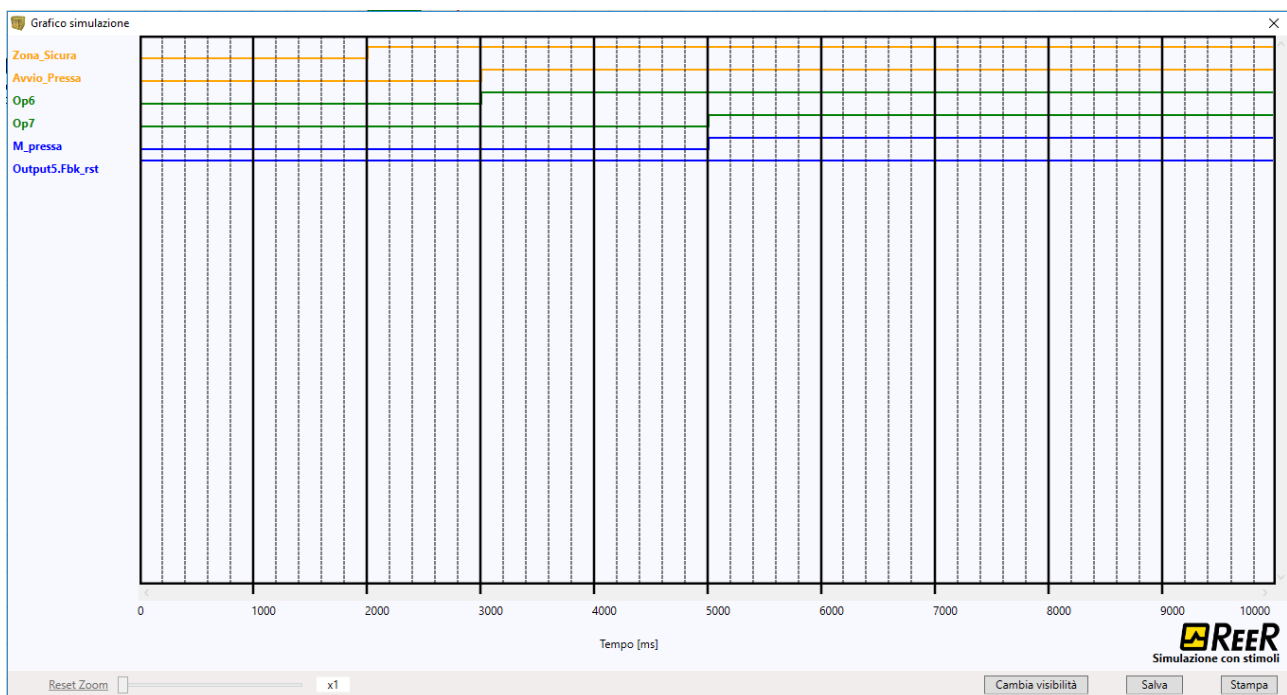



Figure 127 - Graph produced by the simulation of the application example

## Mosaic Fail Codes

In case of malfunction the Mosaic system transmits to the MSD software a code corresponding to the error detected by the master MOSAIC M1, MOSAIC M1S, MOSAIC M1S COM.

To read the code, proceed as follows:

- connect the Master MOSAIC M1, MOSAIC M1S, MOSAIC M1S COM (indicating FAIL by led) to the PC using the USB cable;
- launch the software MSD;
- use the icon  for the connection; a window appears to request the password; enter the password; a window appears with the error code occurred.

The following table lists all possible errors detected and their solution.

CODE	FAIL	RESOLUTION
19D, 20D	<i>The two MOSAIC M1 microcontrollers do not see the same hw/sw configuration</i>	CHECK CORRECT INSERTION OF MASTER AND EXPANSION MODULES CONNECTORS MSC. POSSIBLY REPLACE THE CONNECTORS. IF MCT IS PRESENT, CHECK CONNECTION
65D	<i>Missing communication with slave module</i>	CHECK CORRECT INSERTION OF MASTER AND EXPANSION MODULES CONNECTORS MSC. POSSIBLY REPLACE THE CONNECTORS.
66D	<i>2 or more same expansion modules with the same node number</i>	CHECK THE CONNECTIONS PIN 2, 3 EXPANSION MODULES
68D	<i>Exceeded max expansion modules number</i>	DISCONNECT THE MODULES IN EXCESS (MAX14)
70D	<i>One or more modules have detected a change in the node number</i>	CHECK THE CONNECTIONS OF PIN 2, 3 EXPANSION MODULES
73D	<i>A slave module has detected an external error</i>	CHECK THE ERROR CODE ON MODULE FOR MORE INFORMATION
96D...101D	<i>Errors related to memory MCM</i>	REPLACE MCM MEMORY
137D	<i>from a MOR4 MOR4S8 - EDM error on the couple RELAY1 and 2 used in Category 4</i>	CHECK THE CONNECTION OF THE EXTERNAL FEEDBACK CONTACTORS
147D	<i>from MOR4 MOR4S8 - EDM error on the Relay 2 and 3 used in Category 4</i>	CHECK THE CONNECTION OF THE EXTERNAL FEEDBACK CONTACTORS
157D	<i>from a form or MOR4 MOR4S8 - EDM error on the Relay 3 and 4 used in Category 4</i>	CHECK THE CONNECTION OF THE EXTERNAL FEEDBACK CONTACTORS
133D (Proxi1) 140D (Proxi2)	<i>From a module MV2, MV1 or MV0: over-frequency detected on Proximity input</i>	THE INPUT FREQUENCY MUST BE $\leq 5\text{kHz}$
136D (Encoder1) 143D (Encoder2)	<i>From a module MV2, MV1 or MV0: encoder input signals not Standard (duty cycle, phase displacement)</i>	THE DUTY CYCLE MUST BE: $50\% \pm 33\%$ OF THE PERIOD (HTL, TTL). THE PHASE DISPLACEMENT MUST BE: $90^\circ \pm 45^\circ$ (HTL, TTL) (not applicable to SIN / COS)
138D (Encoder1) 145D (Encoder2)	<i>From a module MV2, MV1 or MV0: over-frequency detected on Encoder input</i>	THE INPUT FREQUENCY MUST BE: $\leq 500\text{kHz}$ (TTL, SIN/COS); $\leq 300\text{kHz}$ (HTL).
130D 135D 137D 138D 140D 194D 197D 198D 199D 201D 202D 203D 205D	<i>Errors solid state output OSSD1</i>	CHECK THE OSSD1 CONNECTIONS RELATIVE TO THE MODULE IN ERROR
144D 149D 151D 152D 154D 208D 211D 212D 213D 215D 216D 217D 219D	<i>Errors solid state output OSSD2</i>	CHECK THE OSSD2 CONNECTIONS RELATIVE TO THE MODULE IN ERROR
158D 163D 165D 166D 168D 222D 225D 226D 227D 229D 230D 232D 233D	<i>Errors solid state output OSSD3</i>	CHECK THE OSSD3 CONNECTIONS RELATIVE TO THE MODULE IN ERROR
172D 177D 179D 180D 182D 236D 239D 240D 241D 243D 244D 245D 247D	<i>Errors solid state output OSSD3</i>	CHECK THE OSSD3 CONNECTIONS RELATIVE TO THE MODULE IN ERROR
129D	<i>MA4 Measures incongruency</i>	RETURN THE UNIT TO REER
130D, 134D, 142D	<i>MA4 Channel 1 failure</i>	RETURN THE UNIT TO REER
131D, 135D, 143D	<i>MA4 Channel 2 failure</i>	RETURN THE UNIT TO REER
132D, 136D, 144D	<i>MA4 Channel 3 failure</i>	RETURN THE UNIT TO REER
133D, 137D, 145D	<i>MA4 Channel 4 failure</i>	RETURN THE UNIT TO REER
138D	<i>MA4 Channel 1 isolated supply failure</i>	RETURN THE UNIT TO REER
139D	<i>MA4 Channel 2 isolated supply failure</i>	RETURN THE UNIT TO REER

CODE	FAIL	RESOLUTION
140D	MA4 Channel 3 isolated supply failure	RETURN THE UNIT TO REER
141D	MA4 Channel 4 isolated supply failure	RETURN THE UNIT TO REER
146D	MA4 Connected an MOSAIC M1S not suitable for the application	USE AN MOSAIC M1S WITH THE RIGHT FIRMWARE VERSION ( $\geq 5.1$ )
147D	MA4 Internal failure	RETURN THE UNIT TO REER

All other codes are related to errors or an internal malfunction. Please replace the module that gave the error or return to Reer for repair and/or debugging and inform REER at the time of shipment.

CODE	FAIL	SOLUTION
1D...31D	Microcontroller Error	TRY TO RESTART SYSTEM. IF ERROR PERSISTS, SEND UNIT TO REER LABORATORY FOR REPAIR.
32D...63D	Mainboard error	
64D...95D	Communication error between units	
96D...127D	MCM memory card error	REPLACE MCM MEMORY CARD
128D...138D	Error module MOR4 relay 1	TRY TO RESTART SYSTEM. IF ERROR PERSISTS, SEND UNIT TO REER LABORATORY FOR REPAIR.
139D...148D	Error module MOR4 relay 2	
149D...158D	Error module MOR4 relay 3	
159D...168D	Error module MOR4 relay 4	
128D...146D	Error units MV encoder interface	TRY TO RESTART SYSTEM. IF ERROR PERSISTS, SEND UNIT TO REER LABORATORY FOR REPAIR.
128D...142D	Error module MO4LHCS8 OSSD1	
143D...156D	Error module MO4LHCS8 OSSD2	
157D...170D	Error module MO4LHCS8 OSSD3	
171D...184D	Error module MO4LHCS8 OSSD4	
128D...143D	Errors MOSAIC M1S, MOSAIC M1S COM, MI804, MO4L OSSD1	
144D...158D	Errors MOSAIC M1S, MOSAIC M1S COM, MI804, MO4L OSSD2	
159D...173D	Errors MOSAIC M1S, MOSAIC M1S COM, MI804, MO4L OSSD3	
174D...188D	Errors MOSAIC M1S, MOSAIC M1S COM, MI804, MO4L OSSD4	
192D...205D	Errors MOSAIC M1, MI802, MO2, MO4 OSSD1	
206D...219D	Errors MOSAIC M1, MI802, MO2, MO4 OSSD2	
220D...233D	Errors MO4 OSSD3	
234D...247D	Errors MO4 OSSD4	

## Errors Log

The errors log can be visualized using the icon  in the standard tool bar.

 Password Required: level 1.

A table will appear with the last 5 errors occurred from the date when the schema was sent to Mosaic or from the date of error log cancellation (icon .

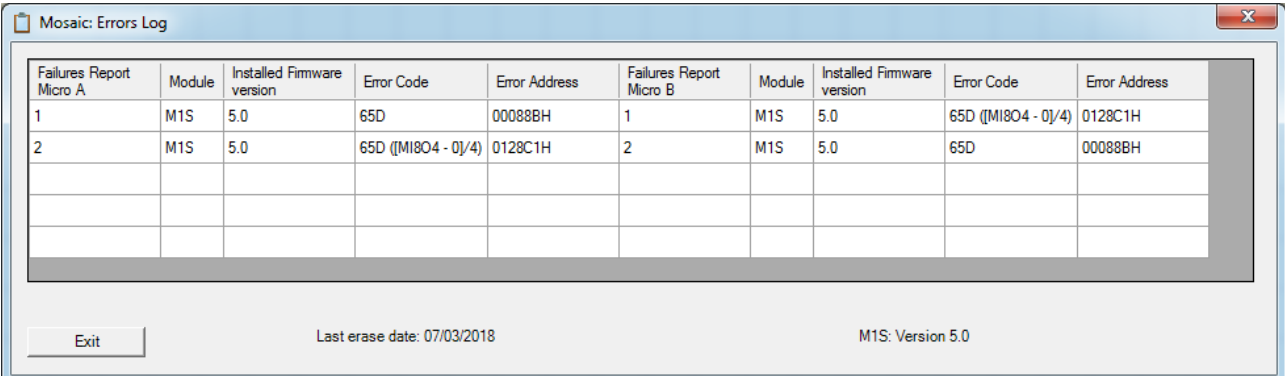

Failures Report Micro A	Module	Installed Firmware version	Error Code	Error Address	Failures Report Micro B	Module	Installed Firmware version	Error Code	Error Address
1	M1S	5.0	65D	00088BH	1	M1S	5.0	65D (MI804 - 0J/4)	0128C1H
2	M1S	5.0	65D (MI804 - 0J/4)	0128C1H	2	M1S	5.0	65D	00088BH

Exit      Last erase date: 07/03/2018      M1S: Version 5.0

Figure 128 – Mosaic Errors Log Table

## ACCESSORIES AND SPARE PARTS

MODEL	DESCRIPTION	CODE
MOSAIC M1	MOSAIC main unit (8 inputs / 2 double OSSD )	1100000
MOSAIC M1S	MOSAIC main unit (8 inputs / 4 single OSSD )	1100003
MOSAIC M1S COM	MOSAIC main unit (8 inputs / 4 single OSSD / fieldbus)	1100006
MI8O2	MOSAIC I/O expansion unit (8 inputs / 2 double OSSD)	1100010
MI8O4	MOSAIC I/O expansion unit (8 inputs / 4 single OSSD)	1100011
MO4L	MOSAIC output expansion unit (4 single OSSD)	1100012
MI8	MOSAIC input expansion unit (8 inputs)	1100020
MI16	MOSAIC input expansion unit (16 inputs)	1100021
MI12T8	MOSAIC input expansion unit (12 input, 8 test output)	1100022
MA2	MOSAIC analog input expansion unit (2 channels)	1100026
MA4	MOSAIC analog input expansion unit (4 channels)	1100025
MO2	MOSAIC output expansion unit (2 double OSSD)	1100030
MO4	MOSAIC output expansion unit (4 double OSSD)	1100031
MO4LHCS8	MOSAIC output expansion unit (4 single OSSD, 8 signal outputs)	1100032
MR2	MOSAIC safety relay unit (2 relays)	1100040
MR4	MOSAIC safety relay unit (4 relays)	1100041
MR8	MOSAIC safety relay unit (8 relays)	1100049
MOR4	MOSAIC safety relay expansion unit (4 relays)	1100042
MOR4S8	MOSAIC safety relay expansion unit (4 relays, 8 signal outputs)	1100043
MOS8	MOSAIC output expansion unit (8 signal outputs)	1100091
MOS16	MOSAIC output expansion unit (16 signal outputs)	1100092
MBP	MOSAIC PROFIBUS DP interface unit	1100050
MBD	MOSAIC DeviceNet interface unit	1100051
MBC	MOSAIC CANopen interface unit	1100052
MBEC	MOSAIC ETHERCAT interface unit	1100053
MBEI	MOSAIC ETHERNET/IP interface unit	1100054
MBEP	MOSAIC PROFINET interface unit	1100055
MBMR	MOSAIC MODBUS RTU interface unit	1100082
MBEM	MOSAIC MODBUS TCP interface unit	1100083
MCT2	MOSAIC BUS TRANSFER interface unit (2 channels)	1100057
MCT1	MOSAIC BUS TRANSFER interface unit (1 channel)	1100058
MBCCL	MOSAIC MBCCL CC-Link interface unit	1100059
MCM	MOSAIC external configuration memory	1100060
MSC	MOSAIC connector for 5-way communication	1100061
CSU	MOSAIC USB cable for connection to PC	1100062
MV1T	MOSAIC TTL expansion unit	1100070
MV1H	MOSAIC HTL expansion unit	1100071
MV1S	MOSAIC SIN/COS expansion unit	1100072
MV2T	MOSAIC TTL expansion unit (2 encoders)	1100073
MV2H	MOSAIC HTL expansion unit (2 encoders)	1100074
MV2S	MOSAIC SIN/COS expansion Unit (2 encoders)	1100076
MVO	MOSAIC proximity expansion unit	1100077
MV1TB	MOSAIC TTL expansion unit	1100086
MV2TB	MOSAIC TTL expansion unit (2 encoders)	1100087

---

## WARRANTY

---

ReeR warrants that all of its MOSAIC units shall be free from defects in material or workmanship for a period of 12 (twelve) months from the date of shipment. This warranty applies to the products under normal conditions of use.

If the product proves to be defective during the warranty period, ReeR will repair or replace any faulty parts without any charge for material or labour.

ReeR S.p.A. may, at its discretion, replace the defective equipment with the same type of equipment or with equipment having the same characteristics, rather than repair it.

This warranty is subject to the conditions listed below:

The customer must inform ReeR of the fault within twelve months from the date of delivery of the product.

The equipment and all components must be in the condition as they were at the time of delivery by ReeR.

The fault or defect must not been caused either directly or indirectly by:

- Improper use;
- Failure to comply with the instructions for use;
- Carelessness, misuse, incorrect maintenance;
- Repairs, modifications, adaptations not performed by ReeR, tampering, etc.;
- Accidents or collisions (also during transportation and as a result of force majeure);
- Other causes for which ReeR cannot be held liable.

The defective equipment must be delivered or shipped to ReeR's works to be repaired: the warranty does not cover costs of transport or the risk of damage to or loss of the equipment during shipment, which shall be borne by the customer.

All products and components that are replaced become the property of ReeR.

ReeR shall not be held liable under any other warranties or rights except for those expressly indicated above. ReeR shall not therefore accept claims to pay damages for expenses, interruption of work or other factors or circumstances in any way related to failure of the product or any parts thereof.

*Please, visit the website [www.reersafety.com](http://www.reersafety.com) for the list of the authorised representative of each Country.*

 Precise, complete compliance with all standards, instructions and warnings in this handbook is essential for the correct operation of the device. ReeR therefore declines any responsibility for all and anything resulting from failure to comply with all or some of the aforesaid instructions.

*Characteristics are subject to change without prior notice. No part of this document may be reproduced unless authorised by ReeR.*



# EC DECLARATION OF CONFORMITY



## Dichiarazione CE di conformità / EC declaration of conformity

Torino, 15/12/2021

REER SpA - via Carcano 32  
10153 – Torino – Italy

dichiara che il controllore integrato MOSAIC costituisce un dispositivo di sicurezza realizzato in conformità alle seguenti Direttive Europee:  
*declares that the integrated controller MOSAIC is a safety device complying with the following European Directives:*

2006/42/EC	"Direttiva Macchine" "Machine Directive"
2014/30/EU	"Direttiva Compatibilità Elettromagnetica" "Electromagnetic Compatibility Directive"
2014/35/EU	"Direttiva Bassa Tensione" "Low Voltage Directive"
2011/65/EU	"Limitazioni sull'uso di sostanze pericolose nelle Apparecchiature Elettriche ed Elettroniche" "Restriction of the use of certain hazardous substances in Electrical and Electronic Equipment"

ed è conforme alle seguenti norme:  
*and complies with the following standards:*

EN 61131-2 (2007)	Controllori programmabili - Parte 2: Specifiche e prove delle apparecchiature. <i>Programmable controllers - Part 2. Equipment requirements and tests.</i>
ISO 13849-1 (2015)	Sicurezza del macchinario: Parti dei sistemi di comando legate alla sicurezza. Parte 1: Principi generali per la progettazione. <i>Safety of machinery:- Safety-related parts of control systems - Part 1: General principles for design.</i>
EN IEC 61496-1 (2020)	Sicurezza del macchinario: Dispositivi Elettrosensibili di protezione, Parte 1: Requisiti generali e tests. <i>Safety of machinery : Electro sensitive protective equipment, Part 1: General requirements and tests.</i>
EN 61508-1 (2010)	Sicurezza funzionale di impianti elettrici/elettronici/programmabili legati alla sicurezza: Requisiti generali. <i>Functional safety of electrical/electronic programmable electronic safety related systems: General requirements.</i>
EN 61508-2 (2010)	Sicurezza funzionale di impianti elettrici/elettronici/programmabili legati alla sicurezza: Requisiti per impianti elettrici/elettronici/programmabili legati alla sicurezza. <i>Functional safety of electrical/electronic/programmable electronic safety related systems: Requirements for electrical/electronic/programmable electronic safety-related systems.</i>
EN 61508-3 (2010)	Sicurezza funzionale di impianti elettrici/elettronici/programmabili legati alla sicurezza: Requisiti Software. <i>Functional safety of electrical/electronic programmable electronic safety related systems: Software requirements.</i>
IEC 62061 (2021)	Sicurezza del macchinario. Sicurezza funzionale dei sistemi di comando e controllo elettrici, elettronici e programmabili correlati alla sicurezza. <i>Safety of machinery - Functional safety of safety-related electrical, electronic and programmable electronic control systems.</i>
EN 81-20 (2020)	Regole di sicurezza per la costruzione e l'installazione di Ascensori. Ascensori per il trasporto di persone e cose. Parte 20: Ascensori per persone e cose accompagnate da persone. <i>Safety rules for the construction and installation of lifts. Lifts for the transport of persons and goods. Passenger and goods passenger lifts.</i>
EN 81-50 (2020)	Regole di sicurezza per la costruzione e l'installazione di Ascensori. Verifiche e prove. Parte 50: Regole di progettazione, calcoli, verifiche e prove dei componenti degli ascensori. <i>Safety rules for the construction and installation of lifts. Examinations and tests. Design rules, calculations, examinations and tests of lift components</i>

raggiungendo il livello di sicurezza pari a: SIL 3 / SILCL 3 / PL e / Cat. 4 / Tipo 4 (v. standard corrispondenti)  
*reaching a safety level corresponding to: SIL 3 / SILCL 3 / PL e / Cat. 4 / Type 4 (see related standards)*

ed è identico all'esemplare esaminato ed approvato con esame di tipo CE da:  
*and is identical to the specimen examined and approved with a CE - type approval by:*

TÜV SÜD Product Service GmbH – Zertifizierstelle – Ridlerstraße 65 – 80339 – München – Germany  
N.B. number: 0123 – Certificate No. Z10 024820 0077 Rev. 01

Carlo Pautasso  
Direttore Tecnico  
Technical Director

Simone Scaravelli  
Amministratore Delegato  
Managing Director



Via Carcano, 32  
10153 Torino, Italy  
T +39 011 248 2215  
F +39 011 859 867  
[www.reersafety.com](http://www.reersafety.com)  
[info@reer.it](mailto:info@reer.it)