



Front dimensions: Ø 28 mm  
Panel cut-out: Ø 22.3 mm  
Front bezel height: 12 mm  
Travel: 6 mm





RONDEX-M





01 Pushbutton Heads	page 220	07 Key Actuators	page 226
02 Emergency Stop Heads	page 222	08 Acoustic Buzzers	page 228
03 Mushroom Heads	page 222	09 Pilot Lights	page 229
04 Knob Set for Potentiometers	page 224		
05 Selector Heads	page 224		
06 Toggle Heads	page 225		
		<b>Contact Blocks / Lampholders</b>	page 414



 degree of protection

 illuminating option

 operating travel

 labelling option

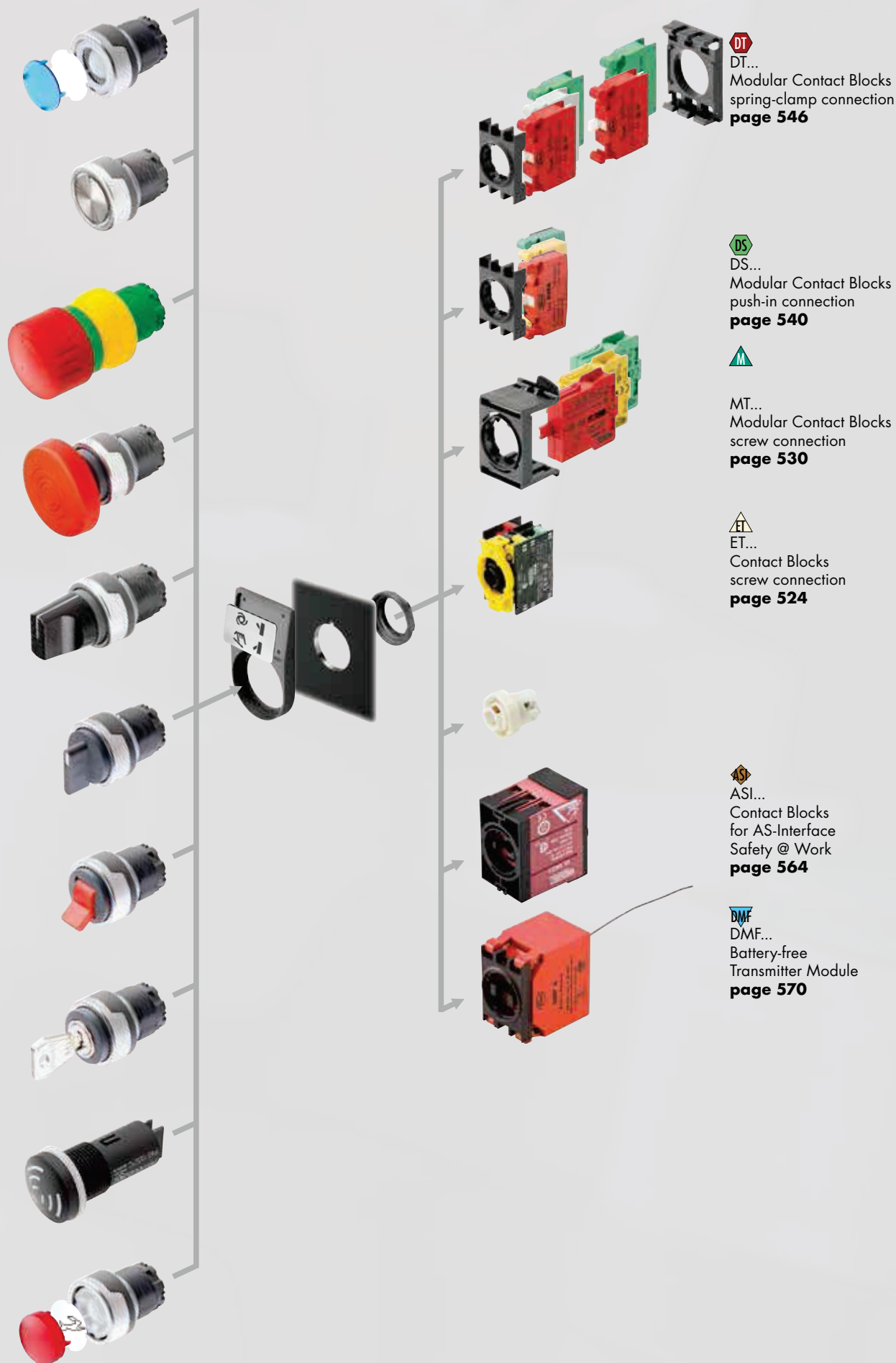

**When combining the DT... contact blocks with key, selector and toggle heads, please add ...\_497 to the actuator type reference!**

## Mounting Depth Dimensions

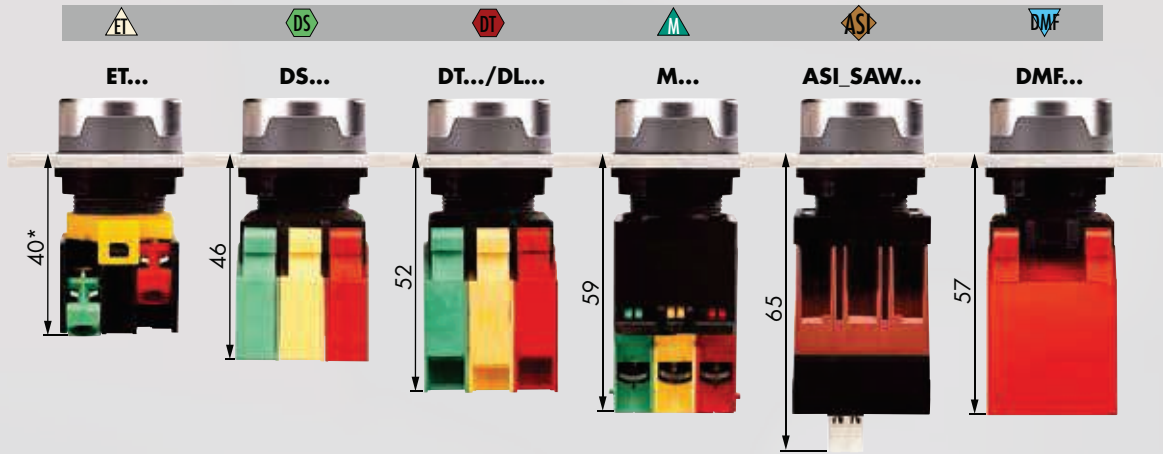

\* ETR2 61mm, ETLR 50mm, ETLR2 70mm, EL9R 36mm

## Cutout Dimensions

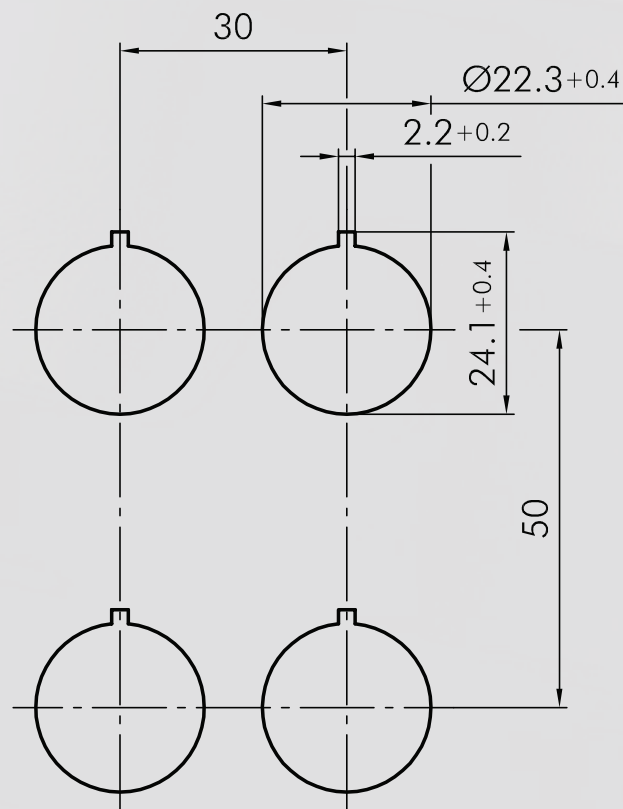

## Mounting and Service Instructions

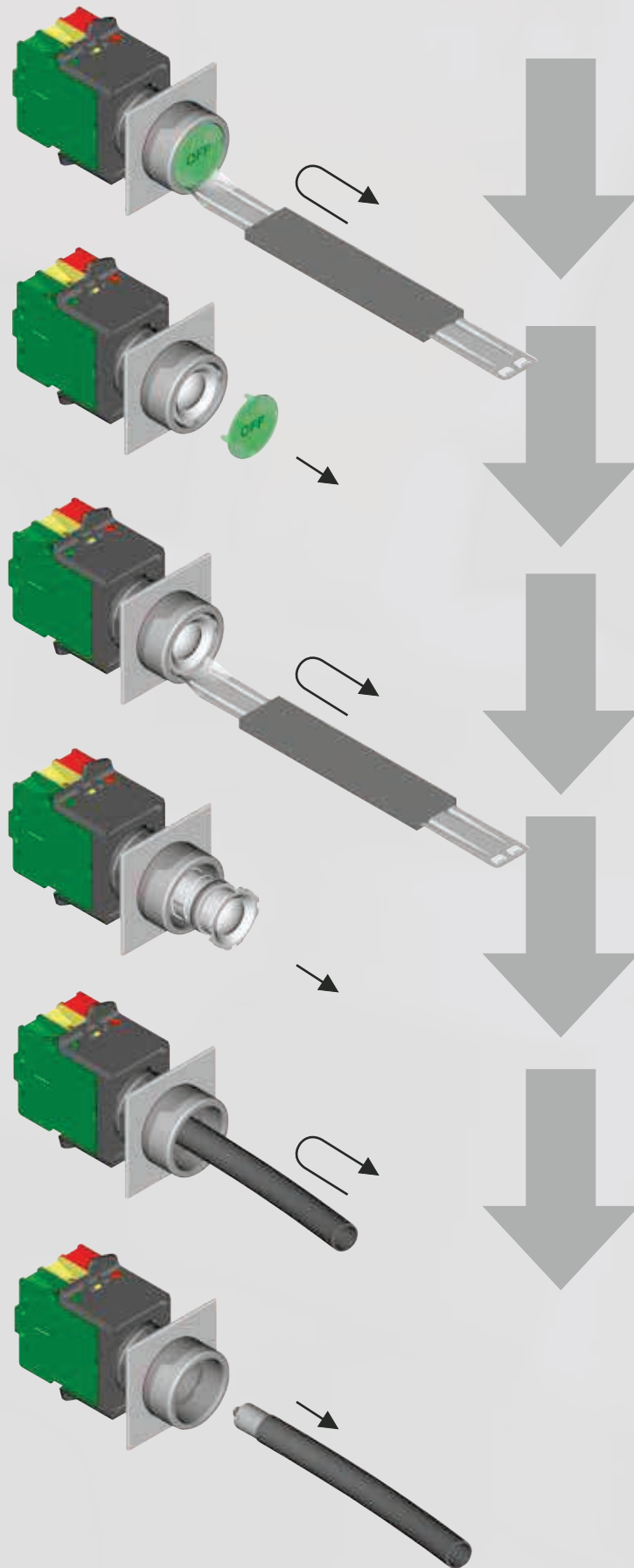









## Pushbutton Heads (momentary/push-push)

Lenses and nameplates to be ordered separately

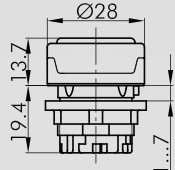
Illustration	Dimensions	Description	Type																		
		<p><b>Pushbutton Head</b> suitable contact blocks</p> <p>DMF DS DT ET M</p> <p>front bezel                      metallic/charcoal</p>	<b>RMCT</b>																		
		<p><b>Pushbutton Head with ring illumination</b> incl. lens, inscription on request</p> <p>suitable contact blocks</p> <p>DS DT ET M</p> <p>front bezel                      metallic/charcoal</p>	<b>RMCTLR</b>																		
		<p><b>Pushbutton Head, maintained</b> suitable contact blocks</p> <p>DMF DS DT ET M</p> <p>front bezel                      metallic/charcoal</p>	<b>RMCF</b>																		
		<p><b>Flat Lens, transparent</b></p> <table border="0"> <tr> <td>colour</td> <td>blue</td> <td><b>TG22BL</b></td> </tr> <tr> <td></td> <td>yellow</td> <td><b>TG22GB</b></td> </tr> <tr> <td></td> <td>green</td> <td><b>TG22GN</b></td> </tr> <tr> <td></td> <td>clear</td> <td><b>TG22KL</b></td> </tr> <tr> <td></td> <td>red</td> <td><b>TG22RT</b></td> </tr> <tr> <td></td> <td>opalwhite</td> <td><b>TG22WS</b></td> </tr> </table>	colour	blue	<b>TG22BL</b>		yellow	<b>TG22GB</b>		green	<b>TG22GN</b>		clear	<b>TG22KL</b>		red	<b>TG22RT</b>		opalwhite	<b>TG22WS</b>	
colour	blue	<b>TG22BL</b>																			
	yellow	<b>TG22GB</b>																			
	green	<b>TG22GN</b>																			
	clear	<b>TG22KL</b>																			
	red	<b>TG22RT</b>																			
	opalwhite	<b>TG22WS</b>																			
		<p><b>Flat Lens, non-transparent</b> used in pushbuttons without inscription and illumination</p> <table border="0"> <tr> <td>colour</td> <td>blue</td> <td><b>TG22GBL</b></td> </tr> <tr> <td></td> <td>yellow</td> <td><b>TG22GGB</b></td> </tr> <tr> <td></td> <td>green</td> <td><b>TG22GGN</b></td> </tr> <tr> <td></td> <td>black</td> <td><b>TG22GSW</b></td> </tr> <tr> <td></td> <td>red</td> <td><b>TG22GRT</b></td> </tr> <tr> <td></td> <td>white</td> <td><b>TG22GWS</b></td> </tr> </table>	colour	blue	<b>TG22GBL</b>		yellow	<b>TG22GGB</b>		green	<b>TG22GGN</b>		black	<b>TG22GSW</b>		red	<b>TG22GRT</b>		white	<b>TG22GWS</b>	
colour	blue	<b>TG22GBL</b>																			
	yellow	<b>TG22GGB</b>																			
	green	<b>TG22GGN</b>																			
	black	<b>TG22GSW</b>																			
	red	<b>TG22GRT</b>																			
	white	<b>TG22GWS</b>																			

## Pushbutton Heads (momentary/push-push)

Illustration	Dimensions	Description	Type
		<b>High Lens, transparent</b> colour            blue yellow green clear red opalwhite	<b>KH23BL</b> <b>KH23GB</b> <b>KH23GN</b> <b>KH23KL</b> <b>KH23RT</b> <b>KH23WS</b>
		<b>High Lens, non-transparent</b> used in pushbuttons without inscription and illumination colour            blue yellow green black red white	<b>TG22GHBL</b> <b>TG22GHGB</b> <b>TG22GHGN</b> <b>TG22GH5W</b> <b>TG22GHRT</b> <b>TG22GHWS</b>
		<b>Nameplate</b> with standard imprint, please specify index number (see nameplates on pages 410)	<b>BSK...</b>
		<b>Nameplate</b> with special imprint according to customer's specifications	<b>BSKB</b>
		<b>Blank Nameplate</b>	<b>BSKU</b>
     		<b>Membrane Pushbutton Head</b> with tightly closed, transparent silicone cap, down to -50 C  suitable contact blocks     	front bezel            metallic/charcoal  <b>RMCTM</b>
		<b>Flat Lens, transparent</b> colour            blue yellow green clear red opalwhite	<b>T20FBL</b> <b>T20FGB</b> <b>T20FGN</b> <b>T20FKL</b> <b>T20FRT</b> <b>T20FWS</b>



## Emergency Stop Buttons Mushroom Heads

Illustration

Dimensions

Description

Type



### Nameplate

with standard imprint, please specify index number (see nameplates on pages 410)

**BSRX...**

### Nameplate

with special imprint according to customer's specifications

**BSRXB**



### Blank Nameplate

**BSRXU**



### For further emergency stops, please refer to the chapter „Emergency-stop Heads“ starting on page 362

The emergency-stop heads can also be supplied as latching mushroom heads with mushrooms in different colours.

IP65

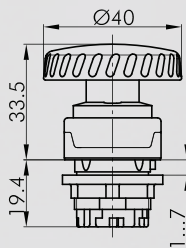

### Mushroom Head, latch-type

with pressure point to avoid accidental actuation

foolproof	No
switching position indicator	No
anti-lock collar	No
release	twist
Standard	DIN EN 60204/VDE 0113

suitable contact blocks



mushroom head	red
front bezel	metallic/charcoal

**RMCV**

IP65

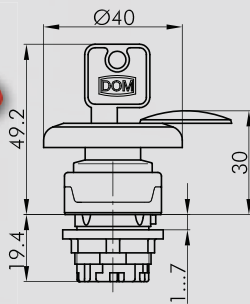

### Mushroom Head, latch-type

with keyhole cover

foolproof	No
switching position indicator	No
anti-lock collar	No
release	key release
Standard	DIN EN 60204/VDE 0113

suitable contact blocks



mushroom head	red
front bezel	metallic/charcoal

**RMCV SCH**

**Mushroom Heads**

Illustration

Dimensions

Description

Type

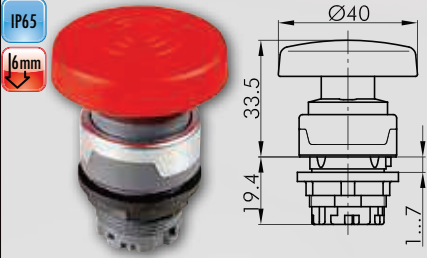

**Mushroom Head, momentary**

other mushroom colours on request

switching position indicator No

anti-lock collar No

suitable contact blocks



mushroom head

red

front bezel

metallic/charcoal











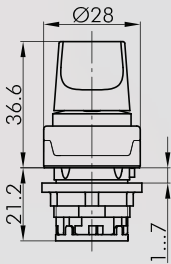

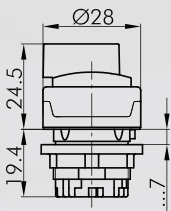

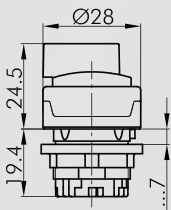

**RMCS**

# RONDEX-M

Ø 22 mm



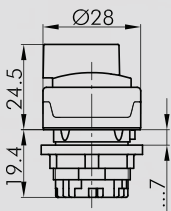









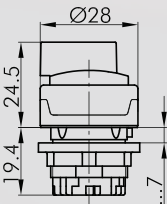











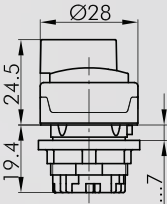



**Knob Set for potentiometers  
Selector Heads (momentary/maintained)**

⊥ = Switching position  
> = Spring return

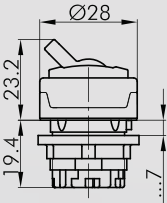
Illustration	Dimensions	Description	Type
		<p><b>Knob Set for potentiometers</b> for potentiometers of 6 mm shaft dia. and thread M10x0.75. Delivery without potentiometer. Shaft length: approx. 50 mm ± 2 incl. fastening thread front bezel metallic/charcoal</p>	<b>RMCR</b>
		<p><b>Selector Head, maintained</b> suitable contact blocks                        front bezel metallic/charcoal                      suitable contact blocks                        front bezel metallic/charcoal</p>	 <b>RMCWA</b>  <b>RMCWB</b>
		<p><b>Selector Head, momentary</b> suitable contact blocks                        front bezel metallic/charcoal                      suitable contact blocks                        front bezel metallic/charcoal</p>	 <b>RMCSTA</b>  <b>RMCSTB</b>
		<p><b>Selector Head, left maintained, right momentary</b> suitable contact blocks                        front bezel metallic/charcoal</p>	 <b>RMCWC</b>

**Selector Heads (momentary/maintained)  
Toggle Heads**

⊥ = Switching position  
> = Spring return

Illustration	Dimensions	Description	Type
  		<p><b>Selector Head, maintained</b> inclusive four small transparent colour plates in red, yellow, green and blue</p> <p>suitable contact blocks     </p> <p>front bezel                      metallic/charcoal</p> <p>suitable contact blocks    </p> <p>front bezel                      metallic/charcoal</p>	 <p><b>RMCWAL</b></p>  <p><b>RMCWBL</b></p>
  		<p><b>Illuminated Selector Head, left maintained, right momentary</b> inclusive four small transparent colour plates in red, yellow, green and blue</p> <p>suitable contact blocks     </p> <p>front bezel                      metallic/charcoal</p>	 <p><b>RMCWCL</b></p>
  		<p><b>Toggle Head</b> with red toggle (other colours on request)</p> <p>suitable contact blocks      </p> <p>knob colour                      red front bezel                      metallic/charcoal</p>	<p><b>RMCK</b></p>

# RONDEX-M

Ø 22 mm

## Key Actuators (momentary/maintained)

- I = Switching position
- > = Spring return
- = Key removable position

Illustration

Dimensions

Description

Type

IP65

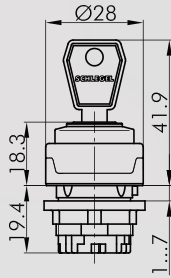

### Key Actuator, maintained

including two keys,  
other lock types on request

suitable contact blocks



front bezel metallic/charcoal

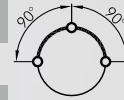

**RMCSA12E**

suitable contact blocks



front bezel metallic/charcoal

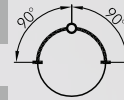

**RMCSA13E**

suitable contact blocks



front bezel metallic/charcoal

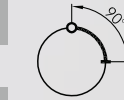

**RMCSA14E**

suitable contact blocks



front bezel metallic/charcoal

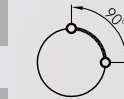

**RMCSA15E**

suitable contact blocks



front bezel metallic/charcoal



**RMCSA17E**

suitable contact blocks



front bezel metallic/charcoal



**RMCSA18E**

IP65

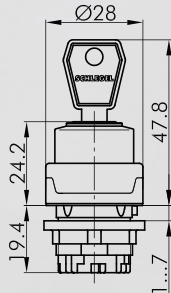

### Key Actuator, momentary

including two keys,  
other lock types on request

suitable contact blocks



front bezel metallic/charcoal

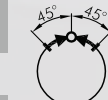

**RMCSA23E**

suitable contact blocks



front bezel metallic/charcoal



**RMCSA27E**

IP65

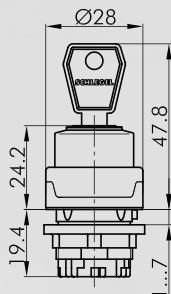

### Key Actuator, left maintained, right momentary

including two keys,  
other lock types on request

suitable contact blocks









front bezel metallic/charcoal

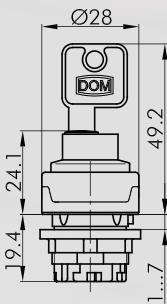

**RMCSA24E**

**Key Actuators (momentary/maintained)**  
**Accessories for Actuators**

Illustration	Dimensions	Description	Type
 <p>IP65</p>	 <p>Ø28 49.2 24.1 19.4 1...7</p>	<p><b>Lockable Pushbutton Head</b> including two keys</p> <p><b>Type N:</b> Depresses with or without key. Lock latches in depressed position and resets with key turned clockwise. Key removable in both positions.</p> <p><b>Type 1:</b> Depresses only with key turned clockwise. Turn key into vertical position, the lock latches. Reset by turning key clockwise. Key removable in both vertical positions.</p> <p><b>Type 2:</b> Depresses only with key in the right position (= basic position). Turn key into vertical position, the lock latches. Key only removable in the latching position. Reset by turning key clockwise.</p> <p><b>Type 3:</b> Depresses only with key turned clockwise. The lock does NOT latch in depressed position (key neither turnable nor removable in depressed position; MOMENTARY). Key only removable in the off-position.</p> <p>suitable contact blocks     </p> <p>front bezel                      metallic/charcoal                      <b>RMCSCHA...</b></p>	
		<p><b>Spare Keys</b> standard spare key, specify key number for special locks</p>	<p><b>ES3A36</b></p>
		<p><b>Spare Key (standard)</b> standard spare key, specify key number for special locks</p>	<p><b>ESE845</b></p>

# RONDEX-M

Ø 22 mm

## Buzzers

Illustration

Dimensions

Description

Type

IP65

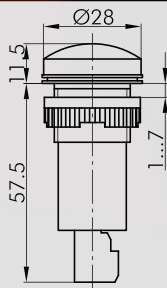

### Buzzer 230V

Operating voltage: 230V~  
Volume: 80 dB at 10 cm distance  
Mounting depth: 60 mm  
max. ambient temperature: -20°C up to 50°C  
Service life: > 5000 h  
front bezel black

**RSG-230V**

IP65

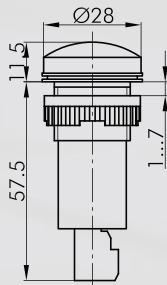





### Buzzer 24V

Operating voltage: 18 - 30V AC/DC  
Volume: 80 dB at 10 cm distance  
Mounting depth: 60 mm  
max. ambient temperature: -20°C up to 50°C  
Service life: > 5000 h  
front bezel black

**RSG-24V**

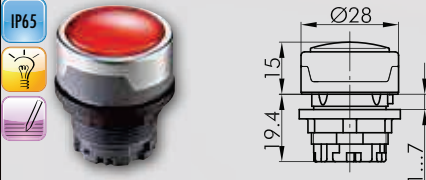
## Pilot Light Heads/Pilot Lights

Lenses and nameplates to be ordered separately





Illustration	Dimensions	Description	Type
	<p><b>Pilot Light Head</b> suitable lampholders</p> <p>front bezel      metallic/charcoal</p>	<p><b>RM CN</b></p>	
	<p><b>Convex Lens</b> colour</p>	<p>blue      <b>KF23BL</b> yellow      <b>KF23GB</b> green      <b>KF23GN</b> clear      <b>KF23KL</b> red      <b>KF23RT</b> opalwhite      <b>KF23WS</b></p>	
	<p><b>High Lens, transparent</b> colour</p>	<p>blue      <b>KH23BL</b> yellow      <b>KH23GB</b> green      <b>KH23GN</b> clear      <b>KH23KL</b> red      <b>KH23RT</b> opalwhite      <b>KH23WS</b></p>	
	<p><b>Nameplate</b> with standard imprint, please specify index number (see nameplates on pages 410)</p>	<p><b>BSK...</b></p>	
	<p><b>Nameplate</b> with special imprint according to customer's specifications</p>	<p><b>BSKB</b></p>	
	<p><b>Blank Nameplate</b></p>	<p><b>BSKU</b></p>	



## Accessories for Actuators

Illustration	Dimensions	Description	Type
		<b>Mounting Tool</b> with torque limitation for the series QUARTEX-R-(JUWEL), KOMBITAST-R-JUWEL, RONDEX, RONDEX-M, RVA, DUX-Basic	<b>S22</b>
		<b>Mounting Tool Adapter with 1/4" connections</b> for mounting tools S16 and S22	<b>SRA</b>
 		<b>External Nameplate Holder</b> for outside marking of the actuators of the RONDEX series, accepts self-adhesive nameplates  colour charcoal	<b>RABT</b>
		<b>Self-adhesive Nameplate, laser-printed</b> Inscription according to customer's specifications Dimensions: 19 x 27 mm	<b>BZ23G</b>
		<b>Self-adhesive Nameplate, blank</b> Dimensions: 19 x 27 mm	<b>BZ23U</b>
		<b>Self-adhesive Nameplate</b> with standard inscription, please specify index no. (see nameplates on pages 410) Dimensions: 19 x 27 mm	<b>BZ23B...</b>
		<b>Yellow Nameplate</b> self-adhesive PVC foil printing on request outer dia. 75 mm for mounting dia. 22 mm colour yellow	<b>NAS_22</b>

## Accessories for Actuators

Illustration	Dimensions	Description	Type
		<p><b>Yellow Nameplate with quadrilingual imprint</b>                      self-adhesive PVC foil                      outer dia. 75 mm                      for mounting dia. 22 mm                      colour yellow</p>	<b>NAS_22_548</b>
		<p><b>Lamp Remover</b>                      for incandescent lamps FZR9...</p>	<b>LZ8</b>
		<p><b>Universal Lens Remover</b></p>	<b>USK</b>
<p>IP65</p> 		<p><b>Dummy</b>                      to close unused mounting apertures                      colour charcoal</p>	<b>BVR22</b>

- Actuators
- Control Units
- Accessories
- Bus Technology
- Exhaust
- Terminal Switches
- Mounting
- Terminal Blocks