

PHOTOELECTRIC BARRIER

ULISSE UPC



INSTALLATION, USE AND MAINTENANCE

CONTENTS

FEATURES	2
OPERATION	3
USE AS A PART OF A SAFETY SYSTEM	3
NEW SAFETY PARAMETERS FOR TYPE 2 BARRIERS AND MANDATORY LABELLING	3
TECHNICAL DATA.....	4
INDICATORS	5
INSTALLATION.....	6
Precautions and mechanical installation	6
Distance from reflecting surfaces	6
Multiple systems.	7
Safety distance and positioning	7
ELECTRICAL CONNECTIONS	8
CHECKS AND MAINTENANCE	9
OPERATING FAULTS.	9
MECHANICAL DIMENSIONS	10
IDENTIFICATION LABELS.....	11
S/N field codification:	11
ORDERING CODES AND SPARE PARTS	11
Ordering codes	11
Spare parts	11
WARRANTY	12
CE DECLARATION OF CONFORMITY.....	13
UKCA DECLARATION OF CONFORMITY	14

CAUTION

Ulisse UPC photocell meets the requirements of a type 2 safety device only if connected with a certified safety interface in accordance with the Machine Directive 2006/42/EC and with the standard IEC 61496-1, 2. ReeR S.p.A. will not be liable for any consequence arising from the use of Ulisse UPC photocells under conditions differing from the ones described above.

FEATURES

- Through-beam barrier type photocell
- Robust and compact metal housing with flat glass lenses. Ulisse is therefore vibration-resistant, as well as easy to clean and immune to the electrostatic attraction of dust. This makes it particularly suitable for the use in the **textile industry environment**.
- Power supply lines protected towards reverse polarity connections.
- PNP type switching output protected towards short-circuit.
- No false triggering on power-up.
- Test input, which allows the sensor to be tested by a remote controller
- Suitable for risk applications according to IEC 61496 (**see par. "Use as a part of a safety system"**).
- Led indicators on both emitter and receiver.
- Complies with 2014/30/EU ("EMC Directive") and 2014/35/EU ("Low voltage directive").
- Miniature M8 connector.

Ulisse is also available in the UNC version which, in connection with the control units REER AUSX and AUSXM, can form a type two, through-beam, single or double-beam safety light barrier.

OPERATION

When the optical path of the infrared beam linking the emitter with the receiver is totally interrupted the receiver output switches off and remains in the off-state.

When the beam is released again, the output switches to the on-state.

The correct operation of the photocell is checked by means of the test function, which permits the measurement the response time: if a low level signal is applied to the emitter's test input the beam emission is interrupted and therefore the receiver goes to the off-state within a time approximately equal to 8 msec in a normal operating condition.

USE AS A PART OF A SAFETY SYSTEM

Ulisse UPC has been third-party certified as being in compliance with the requirements of IEC 61496 which are relevant for a photoelectric sensor (see enclosed certificate).

Thanks to the test input on the emitter assembly the Ulisse UPC photocells can be connected with safety devices (e.g. safety-related parts of control systems) measuring their response time.

Ulisse UPC can therefore be used as a single beam photoelectric detector within a Type 2 safety system for the protection of human beings exposed to hazardous machines or areas **if the overall safety system has been certified as being in compliance with the safety requirements of the "Machine" Directive 2006/42/EC or of a relevant IEC or European Standard (IEC or EN 61496).**

No other use of Ulisse UPC as a safety device is admitted. REER will not be liable for any consequence arising from the use of Ulisse photocells under conditions differing from the ones described above.

NEW SAFETY PARAMETERS FOR TYPE 2 BARRIERS AND MANDATORY LABELLING

With the publication of Edition 3 of the harmonized EN 61496-1 standard it is no longer possible to use a Type 2 safety light barrier for safety functions assessed as SIL 2 / PL d.

If a safety level of SIL 2 / PL d (or higher) is required and it is nevertheless intended to use a safety light barrier, then it will be necessary to use a Type 4 safety light barrier.

This regulatory requirement derives from the fact that the reduction of risk that can be obtained via a photoelectric safety barrier is not only a function of the safety level of its electronic parts, but is also determined by its systematic capabilities (for example: environmental influences, EMC, optical performance and detection principle).

The systematic capability of a Type 2 photoelectric barrier may in fact not be sufficient to ensure adequate risk reduction for SIL 2 / PLc applications.

The standard also establishes that the labelling of Type 2 safety barriers must indicate such limitation to SIL 1 / PLc.

The PFHd values declared for the electronic control part of the device, on the other hand, are not limited and therefore it is possible to use the PFHd value provided by the manufacturer of the device in the global assessment of the safety function, even if it exceeds the SIL 1 / PLd range.

TECHNICAL DATA

MODEL		UPCE-EMITTER	UPCR-RECEIVER
Safety level		Type 2 - SILCL 1 - PL c - Cat.2 (when used with the AUSX, AUSXM units)	
PFH (IEC 62061)		8,04E-09	
DC _{avg} (ISO 13849-1)		90%	
MTTF (ISO 13849-1)		100	
CCF (ISO 13849-1)		80%	
Scanning range	m	0,8 ÷ 6	
Minimum detectable item	mm	8	
Immunity to ambient light	lx	> 10.000 (solar)	
Emission angle		± 5°	
Emission wavelength	nm	880 (modulated infrared)	
Response time	ms	≤ 8	
Power supply	Vdc	24 ± 20%	
Power consumption at 24 Vdc	W	0,7	0,4
Output			PNP 100 mA max Light on
Test input		PNP active low	
Connections		M8 Connector	
Operating temperature	°C	0 ÷ 55 (with no condensate and no frosting)	
Protection degree		IP 65	
Dimensions	Width	15	
	Depth	25	
	Height	63	
Weight	g	40	

INDICATORS

	COLOUR	STATE	INDICATION
EMITTER	Yellow	ON	Beam emitted
	Yellow	OFF	Test function or no beam
RECEIVER	Green	ON	Controlled area is free
	Green	OFF	Controlled area is obstructed



Figure 1

INSTALLATION

Precautions and mechanical installation

Before installation please consider that:

- Neither the emitter nor the receiver have to be placed in the proximity of high-intensity or blinking light sources
- If the system is installed in places undergoing sudden temperature variations it is necessary to adopt the customary measures to prevent the formation of condensate on the lenses, as this might impair their detection capability.

The emitter and the receiver must be installed one in front of the other at a distance which must not exceed the operating range.

☞ A good alignment between the emitter and the receiver is necessary for the correct operation of the photocell. The green led on the receiver, indicating a sufficient intensity of the received signal, can help for this purpose.

Distance from reflecting surfaces

Reflecting surfaces located next to the photocell(s) may cause spurious reflections that would close the optical path between the emitter and the receiver and inhibit the system's detection capability (fig. 2).

Having completed the installation, check for the presence of reflecting surfaces which might intercept the beam, first in the centre and then in the proximity of the emitter and the receiver. If any object is intercepted, the green led located on the receiver (fig. 1) must never light up.

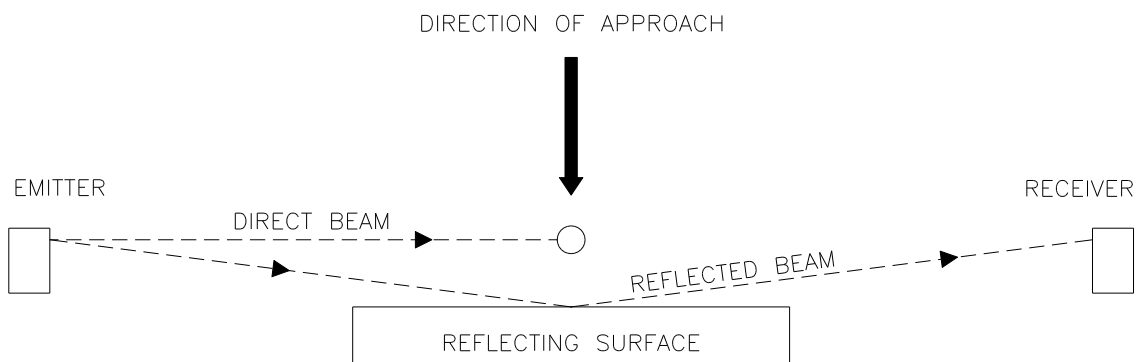

Figure 2

Multiple systems.

When using 2 pairs of ULISSE UPC photocells arranged next to or on top of each other in order to prevent them from mutually interfering it is necessary to arrange the elements so that the beam emitted by one system is received only by the respective receiver (fig. 3).

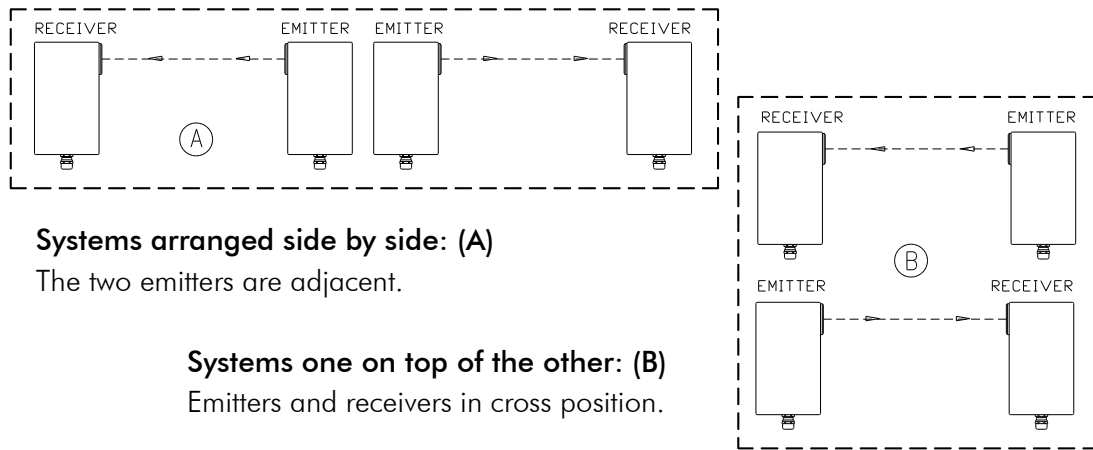

Figure 3

Safety distance and positioning

The photocell must be installed at a distance greater than or equal to the minimum safety distance, S , so that no hazardous point can be reached until the hazardous action of the machine has stopped (fig. 4).

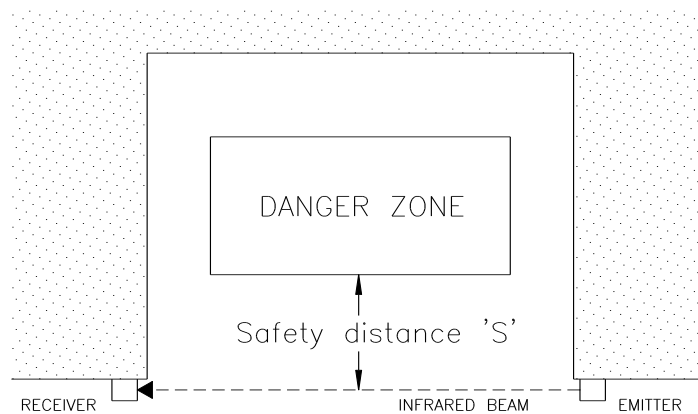

Figure 4

With reference to the proposed European standard ISO 13855, the minimum safety distance, S , must be calculated through the following formula:

$$S = Kt + C$$

where:

S is the minimum safety distance expressed in mm.

K is the speed of approach of the body to the hazardous zone in mm/sec.

t is the overall system reaction time, including the reaction time of Ulisse single or double beam, the reaction time of the safety interface and the stopping time of the machine.

ELECTRICAL CONNECTIONS

Ulisse UPC is fitted with a 3 pin M8 male connector (fig. 5).

It is possible to use 5 m or 15 m cables equipped with an M8 female connector, either straight or at 90°, which can be supplied upon request.

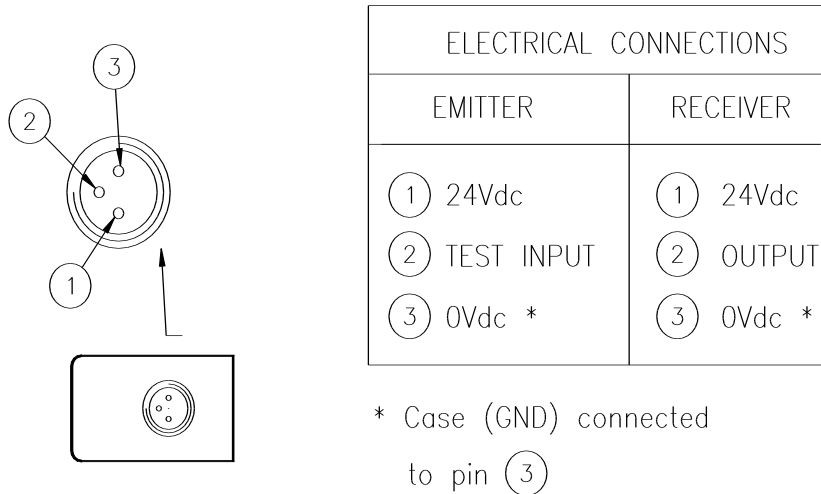

Figure 5

- Before making the connections, make sure that the mains voltage value corresponds with the one indicated in the technical data.
- Use a PELV type 24 Vdc \pm 20% power supply (e.g. through an insulating transformer complying with CEI EN 61558).
- **The connector pin n° 3 is electrically connected with the metal case of the photocell. If the photocell has to be linked to a metal part of the machine which is connected with the ground, the return line of the 24 Vdc voltage distribution system has to be connected with the ground too. If this is not so, the photocell case must be insulated from the metal part of the machine.**
- **For connections whose length is over 50m use cables having a cross section =1mm².**
- The line powering Ulisse should be kept separate from the lines powering the other electrically operated devices (electrical motors, inverters, frequency variators) and the other possible sources of noise.
- Signal lines, i.e. the test input and the output line, must follow a different path with respect to the power cables.

CHECKS AND MAINTENANCE

The ULISSE UPC photocell has no specific maintenance requirement; at all events, we recommend cleaning the lenses of the emitter and the receiver at regular intervals, so as to prevent an excessive quantity of dust from building up and hampering the optical beam transmission and reception functions, as this may result in the failure of the equipment and the machine connected to it.

Do not use abrasive or corrosive products, or solvents or alcohol which might damage the parts to be cleaned.

OPERATING FAULTS.

If any operating faults persist even if the system is turned off and on, check the conditions of the electrical connections.

Furthermore, make sure that the emitter and the receiver are correctly aligned, and the lenses are perfectly clean. If these measures are not sufficient to restore correct system operation, send the equipment to our laboratories, complete with all its parts, specifying clearly:

- part number;
- date of installation;
- hours of operation;
- type of installation;
- fault observed.

MECHANICAL DIMENSIONS

Emitter and receiver

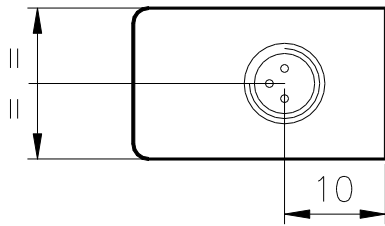

- Ⓐ Optical beam axis
- Ⓑ Indicating led
- Ⓒ M8 male connector

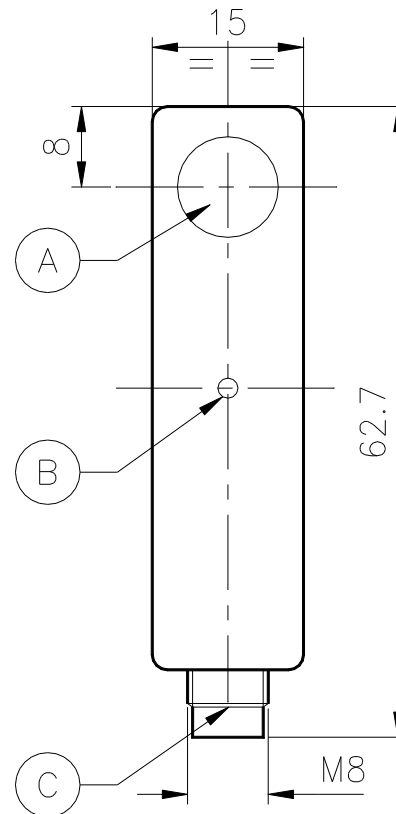
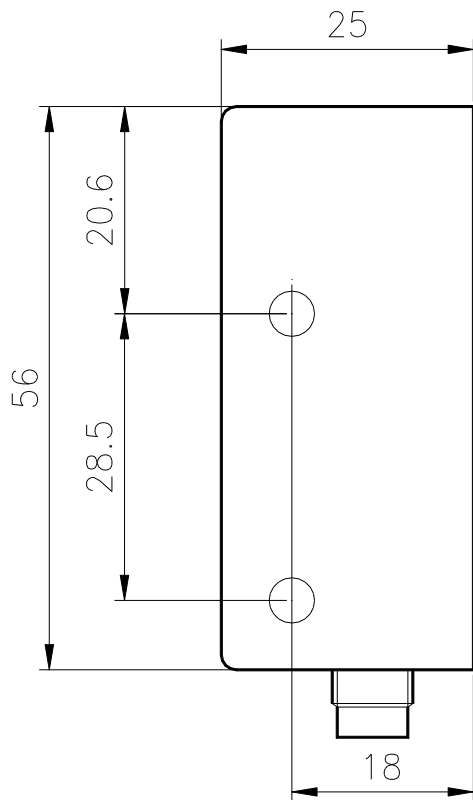

IDENTIFICATION LABELS



S/N field codification:

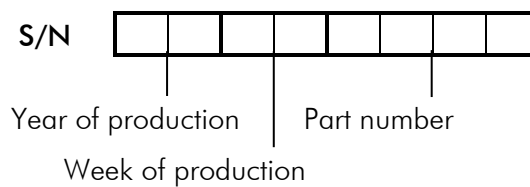

ORDERING CODES AND SPARE PARTS

Ordering codes

ITEM	CODE
Emitter + receiver UPCE + UPCR	1200300
Emitter UPCE	1400300
Receiver UPCR	1500300

Spare parts

ITEM	CODE
Female connector M8 90° (5m cable)	1200216
Female connector M8 (5m cable)	1200217
Female connector M8 (15m cable)	1200219
Female connector M8 90° (15m cable)	1200221

WARRANTY

For each newly produced ULISSE UPC, in regular utilisation conditions, REER S.p.A. warrants the absence of defects in terms of materials and construction for a period of 12 (twelve) months.

During said period, REER S.p.A. undertakes to eliminate any product law by repairing or replacing the defective parts, at no cost to the buyer where both the materials and labour are concerned.

At any rate, REER S.p.A. reserves the right to replace a defective apparatus in its entirety, with another of identical or similar characteristics, instead of repairing individual defective parts, at its discretion.

The validity of this warranty is subject to the following conditions:

- The fault is notified to REER S.p.A. within twelve months of the date of delivery of the product.
- The parts making up the equipment are undamaged.
- The REER part number is clearly legible.
- The fault or malfunctioning has not been directly originated by any of the following causes:
 - Utilisation for purposes other than those the equipment is intended for;
 - Failure to comply with utilisation instructions;
 - Negligence, human errors, inadequate maintenance;
 - Repairs, changes, adaptations not performed by REER personnel, tampering, etc.;
 - Accidents or impact (even those due to transport or force majeure);
 - Other causes independent of REER S.p.A.

Repairs shall be performed at the laboratories of REER S.p.A., where the material must be delivered or shipped to: transport expenses and the risks of damage or loss of materials during shipment shall be borne by the user.

Replaced products and components become the property of REER S.p.A.

REER S.p.A. does not recognise any warranties or rights other than those expressly described above; in no circumstances shall the user be entitled to seek damage for expenses incurred, down-time or any other events associated with faults of the product or parts thereof.

The data and instructions contained in this manual may change as ULISSE products are developed. Since a good knowledge of this manual is essential for correct use and installation, please always refer to the version contained in the product's packaging case.

CE DECLARATION OF CONFORMITY



Dichiarazione CE di conformità EC declaration of conformity

Torino, 12/10/2022

REER SpA
via Carcano 32
10153 – Torino
Italy

dichiara che i sensori di sicurezza della serie **ULISSE UPC** connessi ad una unità di controllo **AUS X** o **AUS XM** oppure ad un controllore di sicurezza **MOSAIC** (adeguatamente configurato) costituiscono un sistema Elettrosensibile di Sicurezza (ESPE) con i seguenti livelli di sicurezza:

- **Tipo 2** (secondo la Norma **EN 61496-1:2013; IEC 61496-2:2013**)
- **SILCL 1** (secondo la Norma **EN 62061:2005/A2:2015**)
- **PL c** (secondo la Norma **EN ISO 13849-1:2015**)

declares that the **ULISSE UPC** series safety sensors connected to a control unit **AUS X** or **AUS XM** or with a correctly configured **MOSAIC** safety controller form an Electro-sensitive Protective Equipment (ESPE) with the following safety levels:

- **Type 2** (according the Standard **EN 61496-1:2013; IEC 61496-2:2013**)
- **SILCL 1** (according the Standard **EN 62061:2005/A2:2015**)
- **PL c** (according the Standard **EN ISO 13849-1:2015**)

che sono realizzati in conformità alle seguenti Direttive Europee:
and are realized in compliance with the following European Directives:

- **2006/42/EC** "Direttiva Macchine"
"Machine Directive"
- **2014/30/EU** "Direttiva Compatibilità Elettromagnetica"
"Electromagnetic Compatibility Directive"
- **2014/35/EU** "Direttiva Bassa Tensione"
"Low Voltage Directive"

e sono identici all'esemplare esaminato ed approvato con esame di tipo CE da:
and are identical to the specimen examined and approved with a CE - type approval by:

TÜV SÜD Product Service GmbH – Zertifizierstelle – Ridlerstraße 65 – 80339 – München – Germany
N.B. number: 0123 – Certificate No. Z10 24820 0081 Rev.00

Responsabile per la documentazione tecnica:
Responsible person for technical documentation:

Carlo Pautasso

Carlo Pautasso
Direttore Tecnico
Technical Director

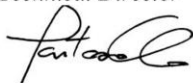

Simone Scaravelli
Amministratore Delegato
Managing Director

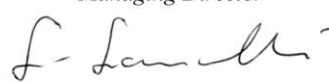

UKCA DECLARATION OF CONFORMITY

ReeR declares that ULISSE UPC photoelectric safety photocells, in conjunction with control unit AU SX, AU SXM or with the safety controller MOSAIC comply with following UK legislation:

- S.I. 2008 No. 1597 - The Supply of Machinery (Safety) Regulations
- S.I. 2016 No. 1101 - Electrical Equipment (Safety) Regulations
- S.I. 2016 No. 1091 - Electromagnetic Compatibility Regulations
- S.I. 2012 No. 3032 - The Restriction of the Use of Certain Hazardous Substances in Electrical and Electronic Equipment Regulations

👉 Please refer to the link <https://www.reersafety.com/certifications/> to download the complete UKCA Declaration of Conformity.